

Operating and Installation Instructions

Ventilation Hood

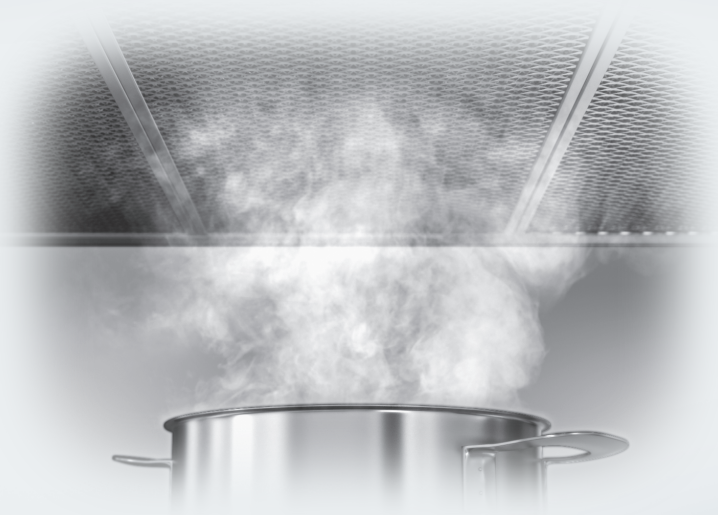

To prevent accidents and damage to the appliance, you **must** read these instructions before installing the appliance and using it for the first time.

Contents

IMPORTANT SAFETY INSTRUCTIONS	4
Caring for the environment	13
Description of functions	14
Con@ctivity 2.0 function	15
Guide to the appliance	16
Operation (Automatic mode)	18
Cooking with Con@ctivity 2.0 (Automatic mode).....	18
Temporarily exiting Automatic mode	20
Resuming Automatic mode	20
Operation (Manual mode)	21
Cooking without Con@ctivity 2.0 (Manual mode).....	21
Turning on the fan	21
Selecting the power level.....	21
Selecting the Delayed shut down time	21
Turning off the fan	21
Turning cooktop lighting On/Off.....	22
Power management	22
Operation (Automatic and Manual modes)	23
Filter saturation indicator	23
Adjusting the filter saturation indicator for grease filters	23
Activating/changing the grease filter saturation counter	24
Checking the elapsed operating time	24
Cleaning and care	25
Stainless steel housing	25
Special instructions for glass surfaces	26
Grease filters	26
OdorFree Charcoal Filter.....	28
Resetting the filter saturation counter for the filter	29
Disposing of the OdorFree Charcoal Filter.....	29
Service and warranty	30
Location of the data plate	30
Installation	31
Before installation	31
Removing the protective film	31
Installation Instructions.....	31
Disassembly.....	31

Contents

Installation parts.....	32
Appliance dimensions.....	34
Distance between cooktop and ventilation hood (S)	35
Installation recommendations.....	37
Drilling diagram for wall mounting	37
Plywood backing	38
To install a plywood backing	38
Exhaust duct.....	39
Condensate trap	40
Reducing Collar	40
Electrical connection	41
Activating Con@ctivity 2.0.....	42
Installation of the Con@ctivity 2.0 stick	42
Activating Con@ctivity 2.0	42
Activating the ventilation hood	42
Activating the cooktop.....	42
Checking activation	42
Deactivating Con@ctivity 2.0	43
Technical data	44

IMPORTANT SAFETY INSTRUCTIONS

READ AND SAVE THESE INSTRUCTIONS

This appliance complies with current safety requirements. Improper use of the appliance can lead to personal injury and material damage.

Read all instructions before installing or using the appliance for the first time. Only use the appliance for its intended purpose.

Keep these operating instructions in a safe place and pass them on to any future user.

Use

- ▶ **CAUTION:** For General Ventilating Use Only. Do Not Use To Exhaust Hazardous Or Explosive Materials And Vapors.
- ▶ This appliance is intended for residential use only. Use only as described in these operating instructions.
- ▶ This ventilation hood is not intended for outdoor use.
- ▶ It must only be used to extract and clean vapors produced during cooking. Any other use occurs at the owner's own risk.
- ▶ This appliance is suitable for installation above gas or electric cooking surfaces.
- ▶ Persons who lack physical, sensory or mental abilities, or experience with the appliance should not use it without supervision or instruction by a responsible person.

IMPORTANT SAFETY INSTRUCTIONS

Children

- ▶ As with any appliance, close supervision is necessary when used by children.
- ▶ Please supervise children in the vicinity of the hood and do not let them play with it.
- ▶ Danger of suffocation! Ensure that any plastic wrappings, bags, etc. are disposed of safely and kept out of the reach of children.

Technical safety

- ▶ **WARNING: TO REDUCE THE RISK OF FIRE, ELECTRIC SHOCK, OR INJURY TO PERSONS, OBSERVE THE FOLLOWING:**
 - Use this appliance only in the manner intended by the manufacturer. If you have questions, contact Miele.
 - Before servicing or cleaning the appliance, switch power off at the service panel and lock the service disconnecting means to prevent power from being switched on accidentally. If the service disconnecting means cannot be locked, securely fasten a prominent warning device, such as a tag, to the service panel.
- ▶ Installation, repair and maintenance work should be performed by a Miele authorized service technician in accordance with national and local safety regulations and the provided installation instructions. Contact Miele's Technical Service Department for examination, repair or adjustment. Repairs and other work by unauthorized persons could be dangerous and may void the warranty.
- ▶ A damaged ventilation hood oven can be dangerous. Always check for visible signs of damage. Never use a damaged ventilation hood.

IMPORTANT SAFETY INSTRUCTIONS

▶ Be certain your appliance is properly installed and grounded by a qualified technician. To guarantee the electrical safety of this appliance, continuity must exist between the appliance and an effective grounding system. It is imperative that this basic safety requirement be met. If there is any doubt, have the electrical system of the house checked by a qualified electrician.

▶ To avoid damaging the ventilation hood, make sure that the connection data (voltage and frequency) on the data plate correspond to the building's power supply before connecting the appliance. When in doubt, consult a qualified electrician.

▶ Do not use a power bar or extension cord to connect the ventilation hood to electricity. These are a fire hazard and do not guarantee the required level of appliance safety.

▶ To ensure safe operation, only use the ventilation hood after it has been properly installed.

▶ This ventilation hood may not be used in non-stationary locations (e.g. on a ship).

▶ Only open the housing as described in the enclosed "Installation diagram" and in the "Cleaning and care" section of this manual. Under no circumstances should any other parts of the housing be opened.

Tampering with electrical connections or components and mechanical parts is highly dangerous to the user and can cause operation faults.

IMPORTANT SAFETY INSTRUCTIONS

- ▶ Defective components should be replaced by Miele original parts only. Only with these parts can the manufacturer guarantee the safety of the appliance.
- ▶ If the power cord is damaged, it must only be replaced by a qualified service technician.
- ▶ During installation, maintenance, and repair work, the ventilation hood must be disconnected from the electrical supply. It is only completely isolated from the electricity supply if one of the following applies:
 - The circuit breakers on the electrical service panel are tripped.
 - The screw-type fuses on the electrical service panel have been removed.
 - The power cable (if present) has been unplugged from the socket (pull the plug not the cord).

Proper use

- ▶ **WARNING: TO REDUCE THE RISK OF A COOKTOP GREASE FIRE:**
 - a) Never leave surface units unattended at high settings. Boilovers cause smoking and greasy spillovers may ignite. Heat oils slowly on low or medium settings.
 - b) Always turn the hood on when cooking at a high heat.
 - c) Clean the ventilation hood frequently. Grease should not be allowed to accumulate on the fan or filter.
 - d) Use the proper pan size. Always use cookware appropriate for the size of the cooking area.
- ▶ Never use an open flame beneath the ventilation hood. To avoid the risk of fire, do not flambé or grill over an open flame. When turned on, the ventilation hood will draw any flames into the filter. Fat deposits may ignite.

IMPORTANT SAFETY INSTRUCTIONS

▶ **WARNING: TO REDUCE THE RISK OF INJURY TO PERSONS IN THE EVENT OF A COOKTOP GREASE FIRE, OBSERVE THE FOLLOWING*:**

- a) **SMOTHER FLAMES** with a close fitting lid, cookie sheet, or metal tray then turn off the burner. **BE CAREFUL TO PREVENT BURNS.** If the flames do not go out immediately, **EVACUATE AND CALL THE FIRE DEPARTMENT.**
- b) **NEVER PICK UP A FLAMING PAN** - You may be burned.
- c) **DO NOT USE WATER**, including wet dishcloths or towels - a violent steam explosion will result.
- d) Use a fire extinguisher **ONLY** if:
 - 1) You have a class ABC extinguisher, and you know how to operate it.
 - 2) The fire is small and contained in the area where it started.
 - 3) The fire department is being called.
 - 4) You can fight the fire with your back to an exit.

*Based on "Kitchen Firesafety Tips" published by NFPA.

▶ The ventilation hood may become damaged if exposed to excessive heat from a gas cooktop.

- When using the ventilation hood over a gas cooktop, ensure that any burners in use are always covered by cookware. Turn burners off when removing the cookware, even if doing so for just a short time.
- Select cookware that is suitable for the size of the burner.
- Adjust the flame so that it never extends up the sides of the cookware.
- Avoid overheating the cookware (e.g., when cooking with a wok).

▶ Always turn the ventilation hood on whenever a burner is in use to prevent damage from condensation.

IMPORTANT SAFETY INSTRUCTIONS

▶ Overheated oils and fats can ignite and set the ventilation hood on fire.

When cooking with oils or fats, do not leave pots, pans or fryers unattended. Never leave an electric grill unattended when grilling.

▶ Fat and debris deposits impair the proper functioning of the ventilation hood.

To ensure that cooking vapors are properly cleaned, never use the ventilation hood without the grease filters in place.

▶ A filter containing too much grease is a fire hazard!
The filters should be cleaned or replaced at regular intervals.

▶ Please note that the heat rising from the stovetop during cooking can cause the ventilation hood to become very hot.
Do not touch the housing or the grease filters until the ventilation hood has cooled down.

IMPORTANT SAFETY INSTRUCTIONS

Proper installation

- ▶ **WARNING: TO REDUCE THE RISK OF FIRE, ELECTRIC SHOCK, OR INJURY TO PERSONS, OBSERVE THE FOLLOWING:**
 - a) Installation work and electrical wiring must be done by qualified person(s) in accordance with all applicable codes and standards, including fire-rated construction.
 - b) Sufficient air is needed for combustion and exhausting of gases through the flue (chimney of fuel burning equipment to prevent back drafting. Follow the heating equipment manufacturer's guideline and safety standards such as those published by the National Fire Protection Association (NFPA) and the American Society for Heating, Refrigeration and Air Conditioning Engineers (ASHRAE), and the local code authorities.
 - c) When cutting or drilling into the wall or ceiling, do not damage electrical wiring and other hidden utilities.
 - d) Ducted hoods must always be vented to the outdoors.
 - e) Do not use this hood with any solid-state speed control device.
- ▶ To determine whether a ventilation hood may be operated above your cooking appliance, please refer to the information provided by the appliance's manufacturer.
- ▶ Safety regulations prohibit the installation of a ventilation hood above solid fuel stoves.
- ▶ Insufficient distance between the cooking appliance and the ventilation hood can result in damage to the hood.

The minimum safety distances between the appliance and the bottom of the ventilation hood specified in the "Installation" section must be maintained, unless the appliance's manufacturer has indicated that a greater distance is required.

If more than one cooking appliance is used beneath the ventilation hood, and if different minimum safety distances apply for these appliances, you should use the greater distance.

IMPORTANT SAFETY INSTRUCTIONS

- ▶ Be sure to observe the information contained in the "Installation" section when mounting the ventilation hood.
- ▶ When installing the exhaust duct, only use pipes or tubes made of non-flammable material. These can be obtained from your Miele dealer or from Miele Technical Service.
- ▶ Exhaust air should not be vented into a chimney or vent flue which is otherwise in use and should not be channeled into ducting which ventilates rooms with fuel-burning installations.
- ▶ If exhaust air is to be extracted into a chimney or vent flue no longer used for other purposes, be sure to comply with all applicable regulations.
- ▶ **WARNING: TO REDUCE THE RISK OF FIRE USE ONLY METAL DUCTWORK.**

IMPORTANT SAFETY INSTRUCTIONS

Cleaning and care

- ▶ Never use a steam cleaner to clean the ventilation hood. The steam can reach the electrical components and cause a short circuit.

Accessories

- ▶ Use only genuine original Miele parts. If parts or accessories from other manufacturers are used, the warranty will become void.

FCC Declaration of Conformity

- ▶ These devices comply with FCC Rules Part 15. This equipment has been tested and found to be in compliance with the limits for a Class B digital device, pursuant to Part 15 of the FCC Rules of Operation and is subject to the following conditions:
These devices may not cause harmful interference.
These devices must accept any interference received, including interference that may cause undesired operation.

FCC Radiation Exposure Statement

- ▶ This equipment complies with FCC radiation exposure limits set forth for an uncontrolled environment. This equipment should be installed and operated with minimum distance 8" (20 cm) between the radiator and your body.

Industry Canada Statement

- ▶ This digital apparatus does not exceed the Class B limits for Radio Noise Emissions from digital apparatus set out in the Radio Interference Regulations of the Canadian Department of Communications.

Complies with Canadian ICES-003 Class B specifications.

Disposal of the packing material

The cardboard box and packing materials protect the appliance during shipping. They have been designed to be biodegradable and recyclable.

Ensure that any plastic wrappings, bags, etc. are disposed of safely and kept out of the reach of children.
Danger of suffocation!

Disposal of your old appliance

Do not dispose of this appliance with your household waste.

Old appliances may contain materials that can be recycled. Please contact your local recycling authority about the possibility of recycling these materials.

Before discarding an old appliance ensure that it presents no danger to children while being stored for disposal. Unplug it from the outlet, cut off its power cord and remove any doors to prevent hazards.

Description of functions

The following functions are available on your ventilation hood, depending on the model:

Vented mode

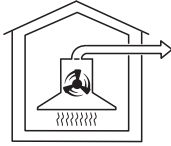

da00494a

Air entering through the intake is cleaned by the grease filters and conducted out of the building.

Non-return flap

A non-return flap in the ducting prevents the exchange of inside and outside air from occurring when the ventilation hood is not in use.

The flap is closed when the ventilation hood is turned off.

When the ventilation hood is turned on, the non-return flap opens so that the exhaust air can be transported outside without any obstruction.

A non-return flap has been provided with the hood in case your ducting does not have one. It is inserted into the outlet duct collar of the fan.

Recirculation mode

(Recirculation mode hoods require a Recirculation kit an OdorFree Charcoal Filter (available as optional accessories), see "Technical Data" for more information.)



da00494b

Air entering through the intake is first cleaned by the grease filters and then by an OdorFree Charcoal Filter. The cleaned air is then recirculated back into the kitchen.

Con@ctivity 2.0 function

Automatic control

This hood features a communication function which enables the automatic control of the hood based on the operational status of a Miele cooktop.

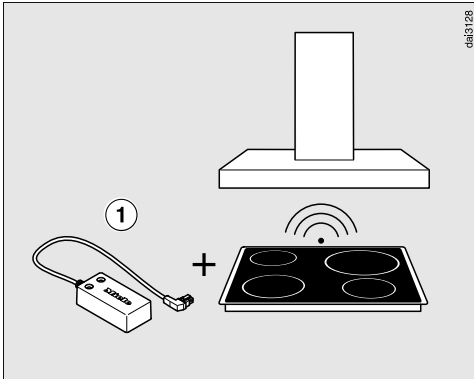

The cooktop transmits information about its operational status to the hood using a radio signal.

- When a burner is turned on, the cooktop lighting on the hood turns on automatically. After a brief delay, the ventilation hood fan also comes on.
- During cooking, the hood automatically selects the fan level based on the number of burners in operation and their power levels.
- Once you have turned off the cooktop, the fan and the lighting will turn off automatically after a predetermined delay.

Detailed information about this function can be found under "Operation."

To enable the communication function, the cooktop must be equipped with the corresponding Con@ctivity 2.0 stick ①.

Please refer to the installation instructions for the Con@ctivity 2.0 stick to determine whether connection to your cooktop is possible.

There must be radio contact between the cooktop and the hood for you to be able to use the Con@ctivity 2.0 function (see "Activating Con@ctivity 2.0").

Guide to the appliance

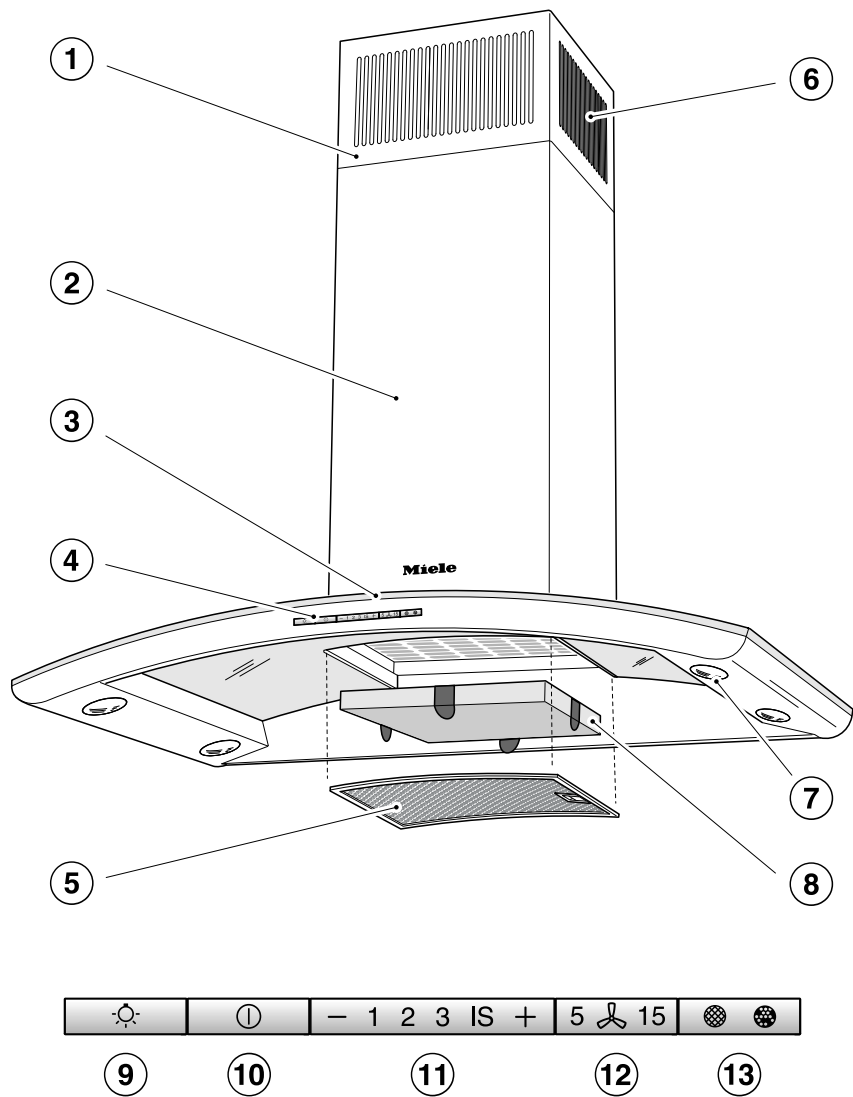

- ① Telescopic chimney
- ② Chimney
- ③ Steam canopy
- ④ Control panel
- ⑤ Grease filter
- ⑥ Recirculation vent
(only for recirculation mode)
- ⑦ Cooktop lighting
- ⑧ OdorFree Charcoal Filter
Optional accessory for recirculation mode
- ⑨ Button for LED cooktop lighting
- ⑩ On/Off button for fan
- ⑪ Buttons for setting the fan power
- ⑫ Button for Delayed shut-down function
- ⑬ Filter saturation indicator

Operation (Automatic mode)

When Con@ctivity 2.0 is active, the hood always operates in Automatic mode (see "Activating Con@ctivity 2.0").

See "Cooking without Con@ctivity 2.0" for information on manually operating the hood.

Cooking with Con@ctivity 2.0 (Automatic mode)

- Turn on a burner to the desired power setting.

The hood lighting will come on.

After a few seconds, the fan will come on, briefly operating at power level **2** before immediately switching to level **1**.

The hood selects the fan level automatically during cooking.

This level is determined by the total output of the cooktop, i.e. the number of burners in operation and the power settings selected.

- If you select a higher power setting on the cooktop or switch on multiple burners, the hood will switch to a higher fan level.
- If you select a lower power setting on the cooktop or turn off a burner, the hood will accordingly switch to a lower fan level.

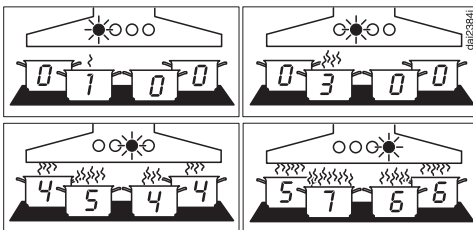

Examples for fan levels **1** to **4**

Reaction time

Changing the power setting on the cooktop does not lead to an immediate increase or decrease in cooking vapors. For this reason, the hood reacts with a slight delay.

Delays can also result from the fact that the cooktop transmits the information to the hood in intervals.

The reaction time can vary from a few seconds to a couple of minutes.

Cooking process

- If, for example, you switch on a burner at the highest power setting to heat cookware in preparation for searing and then reduce the power level after approx. 60 to 90 seconds*, a cooking process is recognized.

The hood turns on automatically and, after the cooktop power level has been reduced, switches back to fan level 3, where it remains for approx. 5 minutes.

After this, the fan level is once again determined by the Con@ctivity function.

- You can also manually select a different fan level before then.

Turning off

- Turn off all burners.

Over the next few minutes, the ventilation hood fan setting will decrease one level at a time until the hood eventually turns off.

This helps to neutralize any lingering vapors and odors in the air.

- From the intensive setting IS, the fan immediately switches to level 3.
- If the fan is operating at level 3, it will switch to level 2 after approx. 1 minute.
- From level 2, the fan switches to level 1 after 2 minutes.
- After 2 minutes at level 1, the fan automatically turns off.
- After another 30 seconds, the lighting turns off.

The cooking process is now finished.

Operation (Automatic mode)

Temporarily exiting Automatic mode

To temporarily exit the Automatic mode when cooking:

- Manually select a different fan level, or
- Manually turn the hood off, or
- Activate the Delayed shut down function  on the ventilation hood. The fan turns off after the delay time selected, and the lighting will remain on.

The ventilation hood functions can now be operated manually (see "Cooking without Con@ctivity 2.0").

Resuming Automatic mode

The ventilation hood resumes Automatic mode:

- If the ventilation hood has not been used for a period of approx. 5 minutes after the manual selection of a fan level, or
- If the manually selected fan level once again matches the automatic setting, or
- If the ventilation hood fan and the cooktop have been turned off for at least 30 seconds. Automatic mode will resume the next time the cooktop is turned on.
- If you wish to manually operate the ventilation hood for a complete cooking process, turn on the ventilation hood fan **before** turning on the cooktop. If the ventilation hood and the cooktop have been turned off for at least 30 seconds after you have finished cooking, Automatic mode will resume the next time the cooktop is turned on.

Cooking without Con@ctivity 2.0 (Manual mode)

The hood can be operated manually if:

- The Con@ctivity 2.0 function is not activated.
- You have temporarily deactivated the Con@ctivity 2.0 function (see "Temporarily exiting Automatic mode").

Turning on the fan

- Press the On/Off button .

The fan turns on at level **2**. The  symbol and **2** will light up in the fan level display.

Selecting the power level

Power levels **1** to **3** can be used for light to heavy cooking vapors and odors.

For strong vapors and odors that are temporarily produced when cooking, e.g. during searing, select the **IS** level as an intensive setting.

- Press the "-" button for a lower power level or the "+" button to select a higher level.

Reducing power of the intensive setting



If power management is activated (default setting), the fan automatically switches back to level **3** after 5 minutes.

Selecting the Delayed shut down time

It is a good idea to let the fan run for a few more minutes after cooking in order to neutralize any lingering vapors and

odors in the air.

With the Delayed shut down function, it is possible to have the fan automatically shut off after a predetermined period of time.

- After you have finished cooking, press the Delayed shut down button **5**  **15**
- Once: fan turns off after 5 minutes (**5** lights up).
- Twice: fan turns off after 15 minutes (**15** lights up).
- If you press the Delayed shut down button **5**  **15** again, the fan remains turned on (**5**  **15** goes out).

Turning off the fan

- Press the On/Off button  to turn the fan off.

The  symbol will go out.

Operation (Manual mode)

Turning cooktop lighting On/Off

The cooktop lighting can be turned on and off separately from the fan.

- To do so, press the  button.



The  symbol is lit when the cooktop lighting is turned on.

Power management

The ventilation hood features a power management system for switching off the lighting and reducing the fan power setting automatically.

- If the intensive setting is selected, the fan automatically switches to level 3 after 5 minutes.
- If the fan is set to level 3, 2 or 1, it switches to the next-highest fan setting after 2 hours and then in 30-minute intervals until the fan eventually switches off.
- If the cooktop lighting is on, it automatically turns off after 12 hours.

Turning power management On/Off

- Turn off the fan and the lighting.
- Press the Delayed shut down button  **15** for approx. 10 seconds until **1** appears in the fan level display.
- Then, press the following buttons in order:
 - The lighting button ,
 - Followed by the "-" button and then
 - The lighting button  again.

If power management is switched on, the **1** and **IS** indicators will be continuously lit.

If it is turned off, **1** and **IS** will flash.

- Press the "-" button to turn power management off.

The **1** and **IS** indicators will flash.

- To turn it on, press the "+" button.

The **1** and **IS** indicators are constantly lit.

- Confirm the setting by pressing the Delayed shut down button  **15**.



All the indicator lights will go out.

If the setting is not confirmed within 4 minutes, the ventilation hood automatically reverts to the old setting.

Operation (Automatic and Manual modes)

Filter saturation indicator





The number of hours the hood has been in operation is stored in appliance memory.

The filter saturation indicators show when the filters need to be cleaned or changed by lighting up the grease filter symbol  or OdorFree Charcoal Filter symbol . Additional information on cleaning and changing the filters and resetting the filter saturation counters can be found under "Cleaning and care."

Adjusting the filter saturation indicator for grease filters

You can set the filter saturation indicator to suit your cooking habits.



The factory default setting is an interval of 30 hours.

- Select a shorter time (20 hours) if you often fry foods.
- We also recommend a shorter cleaning interval if you only cook occasionally. This will prevent grease buildup from hardening and making cleaning more difficult.
- Select a longer cleaning interval of 40 or 50 hours if you use very little fat when cooking.
- Press the On/Off button  to turn the fan off.
- Press the Delayed shut down button **5**  **15** and the filter saturation button   at the same time.

The grease filter symbol  on the filter saturation button and one of the fan power level indicators will flash.

Fan power level indicators **1** to **IS** show the current time setting:

Indicator 1	20 hours
Indicator 2	30 hours
Indicator 3	40 hours
Indicator IS	50 hours

- Press the "-" symbol for a shorter operating time, or the "+" symbol to select a longer operating time.
- Confirm the selection by pressing the filter saturation indicator  .

All the indicator lights will go out.



If the setting is not confirmed within 4 minutes, the ventilation hood automatically reverts to the old setting.

Operation (Automatic and Manual modes)

Activating/changing the grease filter saturation counter

The OdorFree Charcoal Filter is required for recirculation mode.



The filter saturation counter for the OdorFree Charcoal Filter requires one-time activation and must be set to match your cooking habits.

- Press the On/Off button  to turn the fan off.
- Press the "+" symbol and the filter saturation indicator   at the same time.

The OdorFree Charcoal Filter symbol  and one of the fan power level indicators will flash.

Fan power level indicators **1** to **IS** show the current time setting:

Indicator **1** 120 hours
Indicator **2**..... 180 hours
Indicator **3**..... 240 hours
Indicator **IS**..... deactivated





- Press the "-" symbol for a shorter operating time, or the "+" symbol to select a longer operating time.
- Confirm the selection by pressing the filter saturation indicator  .

All the indicator lights go out.

If the setting is not confirmed within 4 minutes, the ventilation hood automatically reverts to the old setting.

Checking the elapsed operating time

Before the set operating time interval has been reached, you can check what percentage of the time has elapsed.

- Press the On/Off button  to switch the fan on.
- Press and hold the filter saturation indicator  :
 - Once, to check the grease filter operating time. The grease filter symbol  lights up.
 - Twice, to check the charcoal filter saturation. The OdorFree Charcoal Filter symbol  lights up.

One or more of the fan power level indicators will flash simultaneously.

The number of flashing indicators shows the elapsed operating time as a percentage.

Indicator **1** 25%
Indicators **1** and **2** 50%
Indicators **1** to **3** 75%
Indicators **1** to **IS** 100%

The elapsed operating time remains stored in the memory when the ventilation hood is turned off or if power to the appliance is lost.

WARNING: TO REDUCE THE RISK OF FIRE, ELECTRIC SHOCK, OR INJURY TO PERSONS, OBSERVE THE FOLLOWING:

- Before cleaning or servicing the hood, disconnect it from the power supply, see "IMPORTANT SAFETY INSTRUCTIONS".

Stainless steel housing

General

The surfaces and control buttons are susceptible to scratching and chipping. Observe the following cleaning instructions.

- Clean all surfaces and control buttons using warm water and liquid dish soap only, applying the mixture with a sponge cloth.

Make sure that no water gets into the interior of the hood. Only use a damp cloth to clean the hood, especially in the control panel area.

- After cleaning, dry the surfaces with a soft cloth.

Avoid the following:

- Cleaners containing soda, acid or chloride, or cleaners containing solvents
- Abrasive cleaners such as scouring powder, scouring liquid, abrasive sponges such as pot scourers, or used sponges that still contain residues from abrasive cleaners

Special instructions for stainless steel surfaces

(does not apply to control buttons)

- Stainless steel surfaces can also be cleaned using a non-abrasive stainless steel cleaner, available from Miele.
- To prevent the surfaces from quickly becoming dirty again, we recommend treating them with a stainless steel care conditioner. Apply sparingly over the entire area using a soft cloth.

Special instructions for RAL color finish housing

(special order)

- Observe the general cleaning instructions contained in this chapter.

Minor scratches on the surface are inevitable when cleaning the housing. Depending on the lighting in the kitchen, this may negatively affect the appliance's appearance.

Cleaning and care

Special instructions for control buttons

Do not leave dirt and debris on the buttons for any length of time. Otherwise they may become discolored or damaged. Remove any dirt or debris immediately.

- Observe the general cleaning instructions contained in this chapter.

Do not use a stainless steel cleaner to clean the control buttons.

Special instructions for glass surfaces

- Glass surfaces can be cleaned using a commercial glass cleaner.

Grease filters

The reusable metal grease filter in the appliance removes solid particles from the kitchen vapors (grease, dust, etc.) preventing soiling of the hood.

 A dirty filter is a fire hazard!

Cleaning intervals

Over longer periods of time, fat buildup on the grease filter hardens and makes cleaning more difficult. Therefore, we recommend cleaning the grease filters once every 3-4 weeks.

Clean the grease filters regularly when the grease filter symbol  on the filter saturation indicator lights up.

- You can adjust the interval of the filter saturation indicator to match your cooking habits (see "Operation").

Removing the grease filters

When handling a grease filter, be careful not to drop it.

This can result in damage to the filter and to the cooktop.

Make sure you hold the filter securely at all times when handling it.

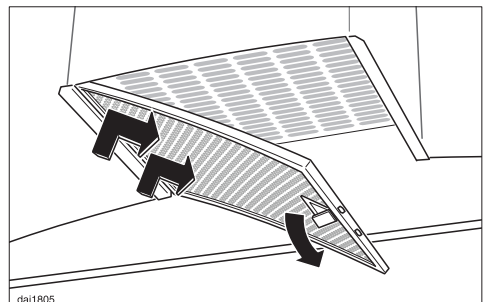

dai1805

- To remove a grease filter, release the locking clip. Then, open the filter to a 45° angle, unhook it, and remove it from the hood.

Cleaning the grease filter by hand

- Clean the filters with a soft nylon brush in a mild solution of hot water and dish soap. Do not use undiluted dish soap.

Unsuitable cleaning agents

Unsuitable cleaners can cause damage to the filter surfaces if used regularly. Do not use any of the following:

- Lime removers
- Abrasive powders or abrasive liquids
- Aggressive all-purpose cleaners and degreaser sprays
- Oven sprays

Cleaning the grease filter in a dishwasher

- Place the filters as upright or inclined as possible in the lower basket. Ensure that the spray arm is not obstructed.
- Use a common household dishwasher detergent.
- Select a program with a wash temperature between 122°F (50°C) and 149°F (65°C).

Depending on the cleaning agent used, cleaning the grease filter in a dishwasher can cause permanent discoloration to the surface. However, this will not affect the functioning of the filter in any way.

After cleaning

- After cleaning, leave the filters on an absorbent surface to dry.
- When removing the filter for cleaning, also clean off any residues of oil or fat from the now accessible casing to prevent the risk of these catching fire.

Cleaning and care

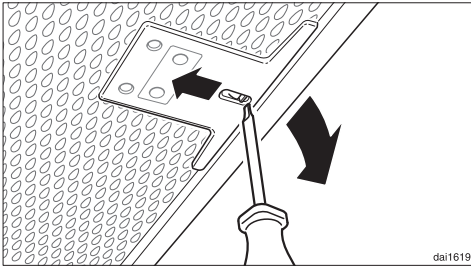

- Replace the grease filter, making sure that the locking clip is facing down towards the cooktop.



- If the filters have been installed incorrectly, you can insert a small screwdriver into the slit to disengage the locking clip.



Resetting the filter saturation counter for the grease filters

Once cleaning is complete, the filter saturation counter must be reset.

- While the fan is turned on, press the filter saturation indicator   for approx. 3 seconds until **1** is the only indicator flashing.

The grease filter symbol  goes out.

When cleaning the grease filters before the full operating time has elapsed:

- Press the filter saturation indicator   for approx. 6 seconds until **1** is the only indicator flashing.

OdorFree Charcoal Filter

If the hood is connected for recirculation, an OdorFree Charcoal Filter must be inserted in addition to the grease filter. This is designed to absorb cooking odors.

It is fitted in the canopy above the grease filter.

OdorFree Charcoal Filters are available from your Miele dealer or from Miele Service. See "Technical data" for the type and reference number.

Installing/replacing the OdorFree Charcoal Filter

- To install or replace the OdorFree Charcoal Filter, the grease filters must first be removed as described above.
- Remove the charcoal filter from its packaging.

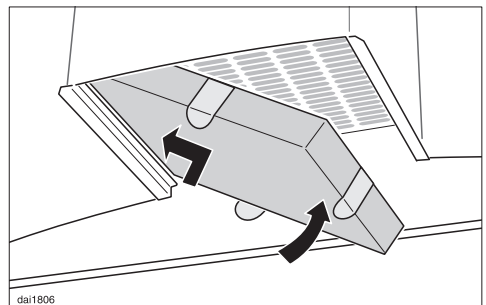

- Insert the charcoal filter into the side of the charcoal filter frame, and then push it up into the frame.
- Replace the grease filter.
- When installing the filter for the first time, activate the filter saturation counter (see "Operation").

When to change the OdorFree Charcoal Filter



- Always replace the OdorFree Charcoal Filter whenever it no longer absorbs kitchen odors effectively. Replace the filter at least once every 6 months.

The OdorFree Charcoal Filter saturation counter  will light up to remind you to change the charcoal filter regularly.



- The OdorFree Charcoal Filter saturation counter requires one-time activation before use (see the "Operation" chapter).

Resetting the filter saturation counter for the filter

If the filter saturation counter is activated, it must be reset each time the filter is changed.

- To do this, press the filter saturation indicator   twice with the fan turned on and hold it for approx. 3 seconds until **1** is the only indicator flashing. The OdorFree Charcoal Filter symbol  will go out.

If you replace the OdorFree Charcoal Filter **before** the full operating time elapses:

- Press the filter saturation indicator   twice and hold it for approx. 6 seconds until **1** is the only indicator flashing.

Disposing of the OdorFree Charcoal Filter

- Used OdorFree Charcoal Filters can be disposed of with normal household waste.

Service and warranty

For faults that you cannot resolve on your own, please contact your Miele dealer or Miele Technical Service.

The telephone number for the Technical Service Department is listed at the back of these instructions.

When contacting Miele, please state the model and serial number of your ventilation hood. These can be found on the data plate.

Location of the data plate

The data plate is visible once you have removed the grease filters.

Warranty

For further information, please refer to your warranty booklet.

Before installation

 Before installing the appliance, read all of the information contained in this chapter and also in the "IMPORTANT SAFETY INSTRUCTIONS" section.

Removing the protective film

The housing components are covered by a protective film to prevent them from becoming damaged during transport.

- Please remove this film before installing the housing components. It can be peeled off easily without any additional tools.

Installation Instructions

Please refer to the accompanying installation sheet for instructions on how to install the appliance.

Disassembly

If the device ever needs to be disassembled, follow the installation sheet instructions in reverse order. A lever is provided to assist with the removal of the chimney.

- Unscrew the two mounting screws on the chimney.

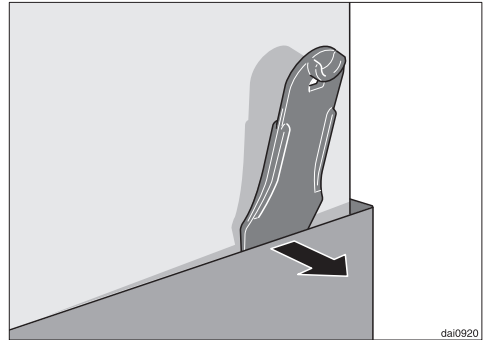

- Slide the supplied lever between the chimney and the extension piece.
- Pry the chimney out of its attachment.

Installation

Installation parts

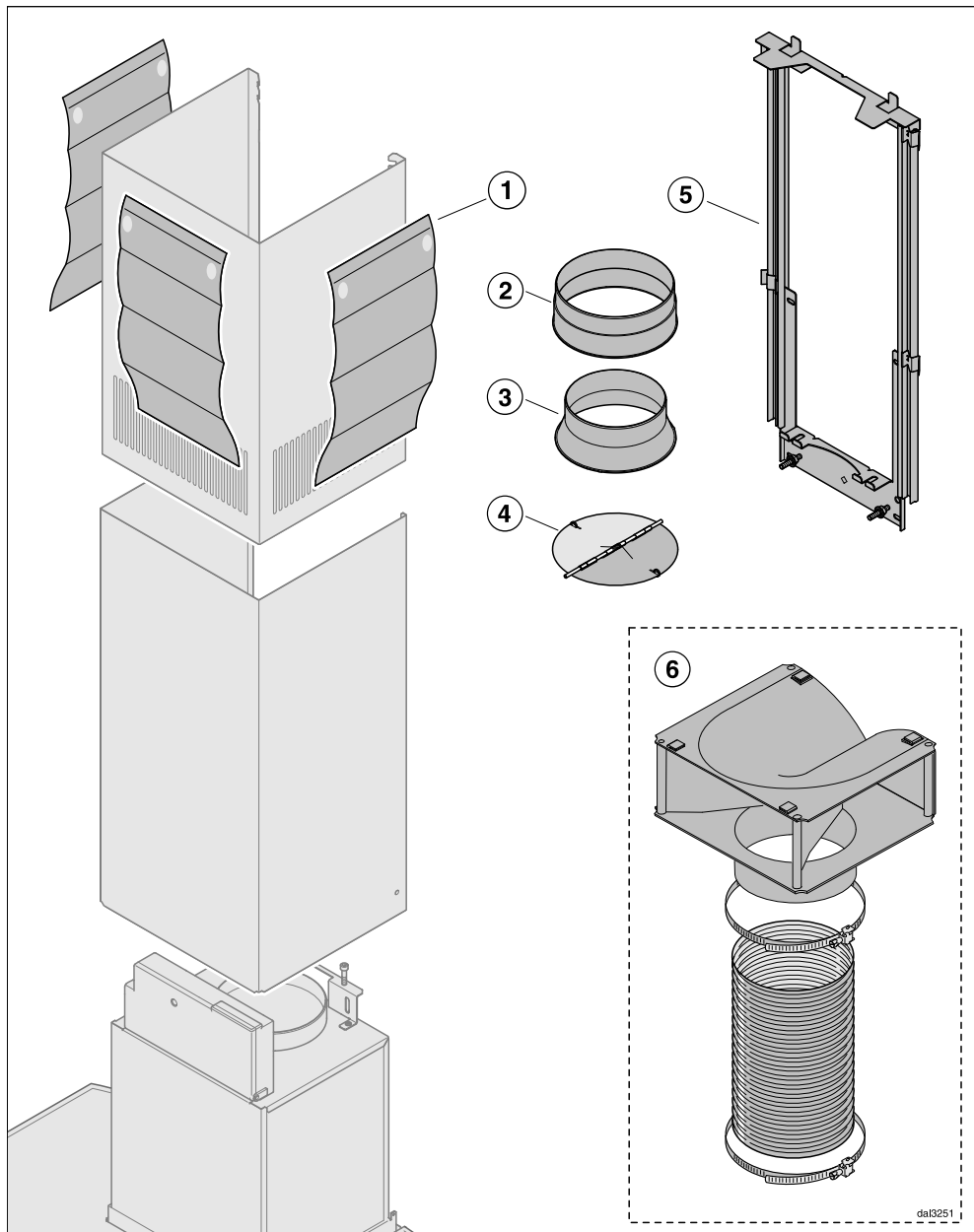

- ① **3 protective installation sheets**
for use when installing the chimney
- ② **1 exhaust connector**
for an exhaust duct \varnothing 6" (150 mm).
- ③ **1 reducer**
for an exhaust duct \varnothing 5" (125 mm).
- ④ **1 non-return flap**
for installation in the outlet duct collar of the motor unit (not for recirculation mode). Depending on the device version, the non-return flap is already mounted.
- ⑤ **Telescopic wall bracket**
for securing the hood on the wall.
- ⑥ **Recirculation kit for recirculation mode**
contains diverter, aluminum hose and hose clamps (not contained in scope of delivery, available as optional accessory – see "Technical Data").



5619e-nDaeB820

6 screws 1/2" x 2 3/8" (5 x 60 mm)
and
6 plugs 5/16" x 2" (8 x 50 mm)
for attaching to the wall. Plugs not for use in USA / CDN.

The screws and plugs are designed for use in solid walls only. Use different fasteners for other wall construction types. Make sure that the wall can support the load.



000316BZ

2 x M 6 lock nuts
for mounting the appliance unit.



082561-30

2 screws 1/8" x 5/16" (3.9 x 7.5 mm)
for attaching the chimney.

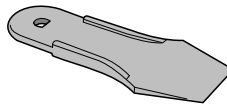

00033716

1 lever
for disassembling the chimney.

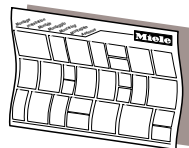

dfrs5m16

Installation sheet

Installation

Appliance dimensions

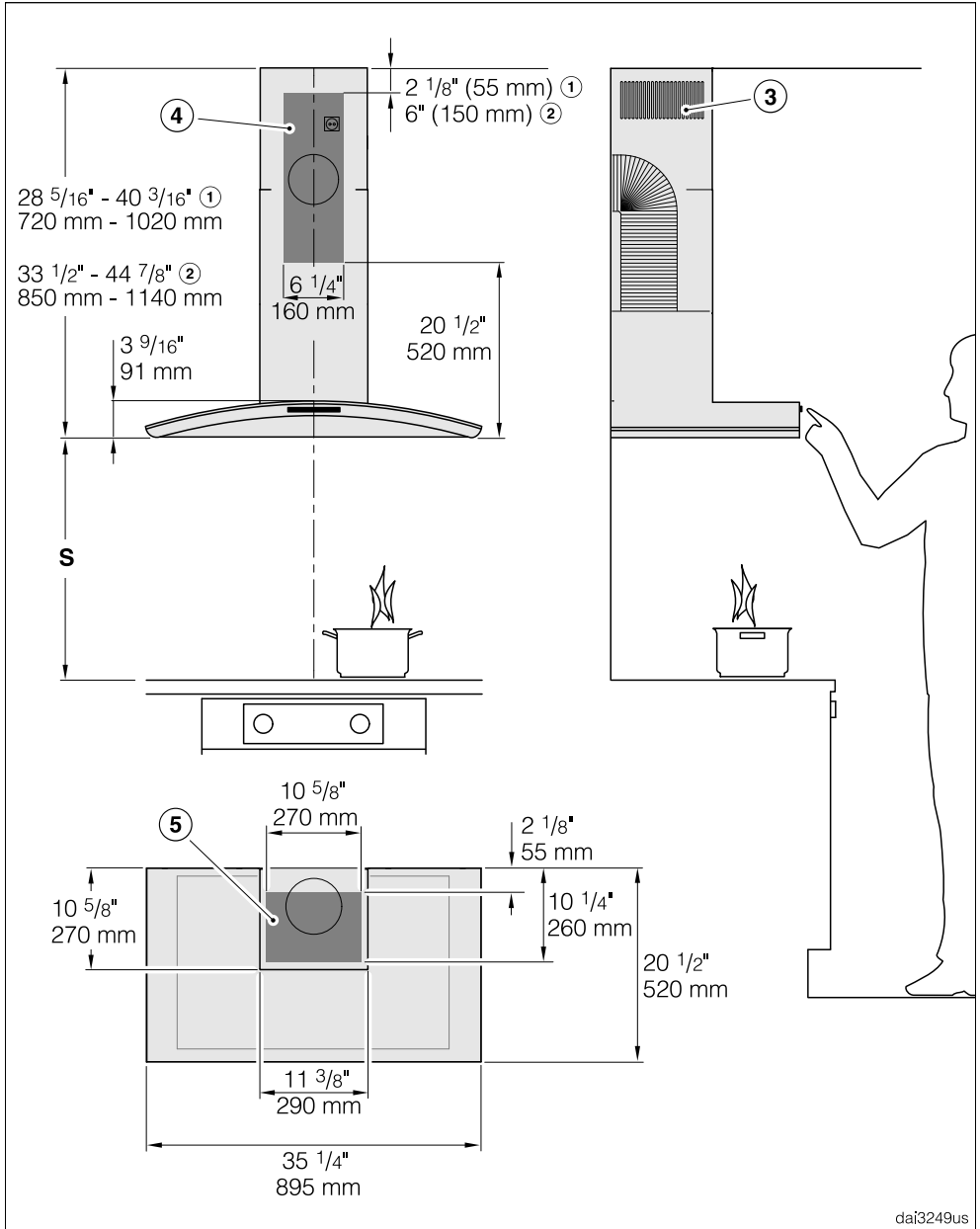

The drawing is not to scale.

- ① Extraction
- ② Recirculation
- ③ Air vent positioned at top for recirculation
- ④⑤ Mounting area (only ④ is required for recirculation ventilation hoods). Wall and ceiling area for exhaust duct opening and for wall socket installation. Only the wall socket installation is required for recirculation hoods.

Vent collar \varnothing 6" (150 mm), with adapter \varnothing 5" (125 mm).

Distance between cooktop and ventilation hood (S)

Provided a larger distance is not given by the manufacturer of the cooktop, follow the minimum safety distances between a cooktop and the bottom of the hood.

Please also observe the information contained in the "IMPORTANT SAFETY INSTRUCTIONS" section.

Installation

Cooking appliance	Minimum distance S	
	Miele appliance	Non-Miele appliance
Electric/Induction cooktop	24" (610 mm)	
Electric grill, deep fat fryer (electric)	26" (660 mm)	
Multi-burner gas cooktop ≤ 43,000 BTU/hr (12.6 W), no burner > 15,000 BTU/hr (4.5 kW).	26" (660 mm)	30" (760 mm)
Multi-burner gas cooktop ≤ 73,800 BTU/hr (21.6 W), no burner > 16,500 BTU/hr (4.8 kW)	30" (760 mm)	
Multi-burner gas cooktop > 73,800 BTU/hr (21.6 W), or one of the burners > 16,500 BTU/hr (4.8 kW)	Not possible	
Single-burner gas cooktop ≤ 20,500 BTU/hr (6 kW)	26" (660 mm)	30" (760 mm)
Single-burner gas cooktop ≤ 27,600 BTU/hr (8.1 kW)	30" (760 mm)	
Single-burner gas cooktop > 27,600 BTU/hr (8.1 kW)	Not possible	

Installation recommendations

- We also recommend a distance of at least 25 1/2" (650 mm) above electric cooktops to provide more workspace and easier cooking under the hood.
- When selecting an installation height, always take the user height into consideration. Users should have ample space to work comfortably on the cooktop and reach the ventilation hood controls with ease.
- Please note that the greater the distance from the cooktop, the less effective the hood is at drawing in the cooking vapors.
- To achieve optimal vapor extraction, make sure that the hood covers the cooktop. The hood should be positioned centrally over the cooktop, not to the side or rear.
- The cooktop should be no wider than the hood. Preferably, it should be narrower.
- The mounting area must be easily accessible. The ventilation hood should be easy to reach and disassemble in case a service call is necessary. This should be taken into consideration when planning the position of cupboards, shelves, ceilings or decorative elements in the vicinity of the ventilation hood.

Drilling diagram for wall mounting

- When drilling, please follow the directions contained on the accompanying installation sheet.

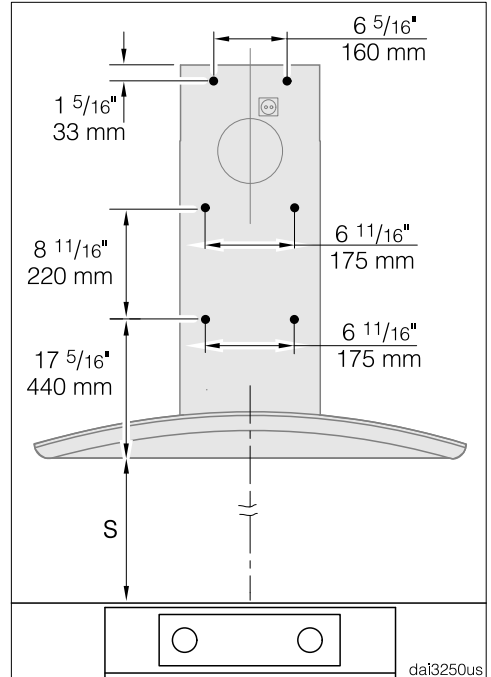

- When installing a custom back wall with pre-drilled holes, please refer to the drilling distances in the drawing above (screws \varnothing 3/16" (5 mm)).

Installation

Plywood backing

The majority of the weight of the installed ventilation system will be supported by the lower retaining plate. It must be firmly attached to the stud framing behind the drywall. If studs are not available in the required locations, a plywood backing (min. 1/2" (13 mm) thick) spanning at least two studs must be installed.

Failure to adequately support the weight as stated may result in the ventilation system falling off the wall, causing personal injury and property damage.

If plywood backing is not needed, proceed to the included "Installation diagram".

To install a plywood backing

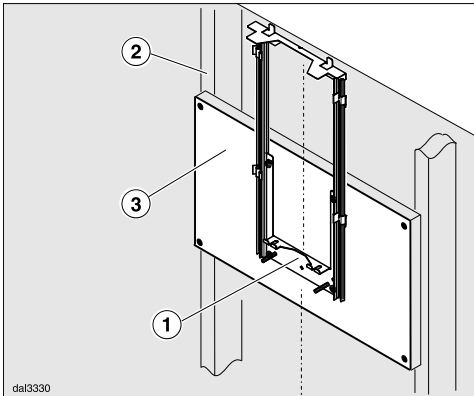

- Determine and mark the location of the retaining plate ① for the canopy as outlined on the "Installation diagram".

- Make a cutting line 3" (76 mm) above and 3" (76 mm) below the outline of the retaining plate.
- Find the studs ② to the left and right of the mounting location by tapping the wall or using a stud finder.
- Mark a vertical cutting line along the center of each stud.

CAUTION: When cutting or drilling into the wall or ceiling, do not damage electrical wiring and other hidden utilities.

- Remove the drywall between the cutting lines and replace it with plywood ③ of a matching thickness (min. 1/2" (13 mm) thick). Tape the joints and refinish the wall.
- Proceed to the enclosed "Installation diagram" to complete the installation.

WARNING: Danger of toxic fumes. Gas cooking appliances release carbon monoxide that can be harmful or fatal if inhaled.

To reduce the risk of fire and to properly exhaust air, the exhaust gases extracted by the hood should be vented outside of the building only.

Do not vent exhaust air into spaces within walls or ceilings or in attics, crawl spaces or garages.

To reduce the risk of fire, only use metal ductwork.

Please read and follow the "IMPORTANT SAFETY INSTRUCTIONS" to reduce the risk of personal injury. Follow all local building codes when installing the hood.

- Make sure that all connections are secure and airtight.

Remember that any constriction of the airflow will reduce extraction performance and increase operating noise.

- If the exhaust duct is to be routed through an outside wall, we recommend installing a telescopic wall vent or a rooftop vent (available as an optional accessory).

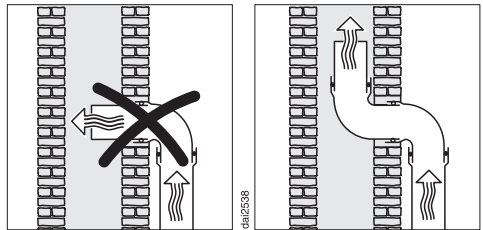

- Only use smooth pipes or flexible duct hoses made from non-flammable materials for exhaust ductwork.
- To achieve the greatest possible air extraction with the lowest noise levels, please note the following:
 - The diameter of the exhaust duct should not be less than 6" (150 mm).
 - If flat exhaust ducts are used, the cross section should not be smaller than that of the exhaust connector.
 - The exhaust duct should be as short and straight as possible.
 - If elbows are needed, make sure they have a large radius.
 - The exhaust duct itself must not be kinked or compressed.
- If the exhaust air is to be conducted into a vent flue, the intake piece must be aligned with the flow direction of the flue.
- When installing the exhaust duct horizontally, you must slope it away from the source by at least 1 cm per meter (3/8" per 3 1/4'). This ensures that condensate cannot drain back into the ventilation hood.
- If the exhaust duct is to be routed through rooms, ceiling space etc., the temperatures in these different areas may differ greatly, which means that the problem of condensation will need to be addressed. The exhaust duct will need to be insulated.

Exhaust duct

Condensate trap

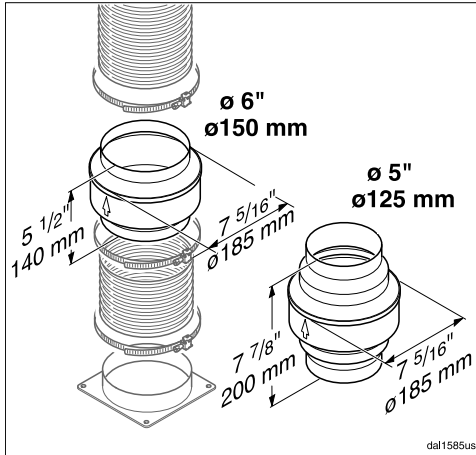

In addition to insulating the exhaust duct, we recommend installing a condensate trap to collect and evaporate any condensate which might accumulate.

Condensate traps are available for exhaust ducts with a diameter of 5" (125 mm) or 6" (150 mm).

- When installing a condensate trap, make sure that it is positioned vertically and, if possible, directly above the hood outlet duct collar. The arrow on the housing indicates the direction of airflow.

Reducing Collar

(optional accessory)

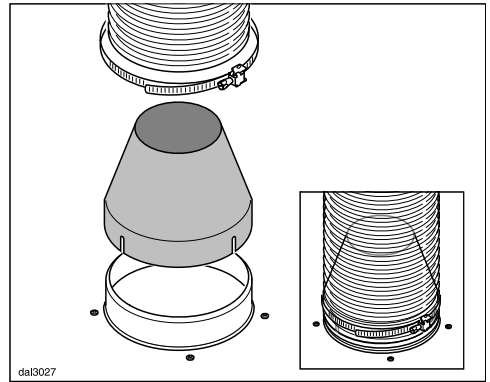

If you would like to reduce the environmental impact of your ventilation system by limiting the CFM output the Reducing Collar can be installed. It reduces the air flow to less than 400 CFM. Check local building codes for max. CFM requirements.

- Push the Reducing Collar on the exhaust port of the fan.
- Push the exhaust hose over it.
- Fix both with a hose clamp.

WARNING: TO REDUCE THE RISK OF FIRE, ELECTRIC SHOCK, OR INJURY TO PERSONS, OBSERVE THE FOLLOWING:

All electrical work should be performed by a qualified electrician in strict accordance with national regulations (for USA: ANSI-NFPA 70) and local safety regulations.

Installation, repairs and other work by unqualified persons could be dangerous.

Ensure that power to the appliance is OFF while installation or repair work is performed.

Verify that the voltage, load and circuit rating information found on the data plate (located behind the baffle filters), match the household electrical supply before installing the hood.

Use only with ventilation hood cord-connection kits that have been investigated and found acceptable for use with this model hood.

If there is any question concerning the electrical connection of this appliance to your power supply, please consult a licensed electrician or call Miele's Technical Service Department.

WARNING: THIS APPLIANCE MUST BE GROUNDED

The hood comes equipped with a power cord with a NEMA 5-15 molded plug for connection to a 120 VAC, 60 Hz, 15 A power outlet.

Grounding Instructions

WARNING - Improper grounding can result in a risk of electric shock.

This appliance must be grounded. In the event of an electrical short circuit, grounding reduces the risk of electric shock by providing a path of least resistance. This appliance is equipped with a cord having a grounding wire with a grounding plug.

If there is any doubt, have the electrical system of the house checked by a qualified electrician.

Do not use an extension cord. If the power supply cord is too short, have a qualified electrician install an outlet near the appliance.

- The plug must be plugged into an outlet that is properly installed and grounded.

WARNING - Grounding instructions (Canada)

The grounding-type attachment plug shall be connected to a grounding-type receptacle installed in accordance with CSA C22.1-12, Canadian Electrical Code, Part I.

Activating Con@ctivity 2.0

Installation of the Con@ctivity 2.0 stick

In order for you to be able to use the Con@ctivity 2.0 function, the cooktop must be equipped with a Con@ctivity 2.0 stick.

- See the relevant installation instructions of the Con@ctivity 2.0 stick.

Activating Con@ctivity 2.0

To use the Con@ctivity 2.0 function, the radio link between the cooktop and the hood must be activated.

Both appliances must be installed and operational.

You only need to carry out the activation procedure once. If the appliances are disconnected from the electricity supply, for example during a loss of power, they will still remain activated.

To establish radio connection, the ventilation hood and cooktop must be activated at the same time. Start activation on the ventilation hood first, and then begin activation on the cooktop.

Activating the ventilation hood

- Turn off the fan, cooktop lighting and cooktop.
- Press the Delayed shut down button  **15** for approx. 10 seconds until the **1** indicator appears in the fan level display.
- Then, press the following buttons in order:

- The "—" button
- Followed by the "+" button
- And then the lighting button .

If Con@ctivity 2.0 has not been activated, the indicators for levels **2** and **3** will flash at the same time.

- To activate Con@ctivity 2.0, press the "+" button.

The hood begins searching for a radio connection. Indicator **2** is continuously lit, and the indicator **3** flashes.

- As this is happening, begin activation on the cooktop.

Activating the cooktop

- **While** the ventilation hood is searching for a signal, start activation on the cooktop. More information can be found in the operating instructions for the cooktop.

Once the radio connection has been established, the indicators **2** and **3** on the hood are continuously lit.

- Confirm activation of the ventilation
- Confirm activation on the cooktop.

The Con@ctivity 2.0 function is now ready for use.



If you do not confirm within 4 minutes, activation will be canceled.

Checking activation

To check whether Con@ctivity 2.0 has been activated for the hood:

- Turn off the fan and cooktop lighting.

Activating Con@ctivity 2.0

- Press the Delayed shut down button **5**  **15** for approx. 10 seconds until the **1** indicator appears in the fan level display.
- Then, press the following buttons in order:
 - The "—" button
 - Followed by the "+" button
 - And then the lighting button .

If Con@ctivity 2.0 has been activated, the indicators for levels **2** and **3** will be constantly lit.

If Con@ctivity 2.0 has not been activated, the indicators for levels **2** and **3** will flash simultaneously.

- To exit the check, press the Delayed shut down button **5**  **15**. All indicators will go out.
- To check whether activation has taken place on the cooktop, please refer to corresponding operating instructions.
- If a connection cannot be established despite activation of the Con@ctivity function on the hood and the cooktop, the function must first be deactivated and then reactivated on both appliances.

Deactivating Con@ctivity 2.0

- Deactivation on the hood is similar to the activation procedure. Select the "—" button instead of the "+" button.
- To deactivate the cooktop, please refer to the corresponding operating instructions.

Please keep in mind that disabling the connection will also disable any remote control function being used. The remote control must then be reactivated.

Technical data

Fan motor	350 W
Cooktop lighting	4 x 3 W
Total connected load	362 W
Voltage, Frequency	120 V AC, 60 Hz
Fuse rating	15 A
Power cord length	2.5 ft (0.75 m)
Weight	57.2 lbs (26 kg)

Optional accessories for recirculation mode:

Recirculation kit DUW 20 and OdorFree Charcoal Filter DKF 12



Contains

FCC ID: 2ACUWEI8800

IC: 5669C-EI8800

This device complies with Part 15 of the FCC Rules and with Industry Canada licence-exempt RSS standard(s). Operation is subject to the following two conditions: (1) this device may not cause harmful interference, and (2) this device must accept any interference received, including interference that may cause undesired operation.

daib3411

Please have the model and serial number
of your appliance available before
contacting Technical Service.

U.S.A.

Miele, Inc.

National Headquarters

9 Independence Way

Princeton, NJ 08540

Phone: 800-843-7231

609-419-9898

Fax: 609-419-4298

www.mieleusa.com

Technical Service & Support

Nationwide

Phone: 800-999-1360

Fax: 888-586-8056

TechnicalService@mieleusa.com

Miele

Canada

Importer

Miele Limited

Headquarters and Miele Centre

161 Four Valley Drive

Vaughan, ON L4K 4V8

www.miele.ca

Customer Care Centre

Phone: 800-565-6435

905-532-2272

customercare@miele.ca

Germany

Manufacturer

Miele & Cie. KG

Carl-Miele-Straße 29

33332 Gütersloh



www.miele-shop.com

DA 5196 W



en-US

M.-Nr. 09 968 410 / 00