

# Operating Instructions

## 30", 36", 48" Ranges

### (Gas Cooktop)

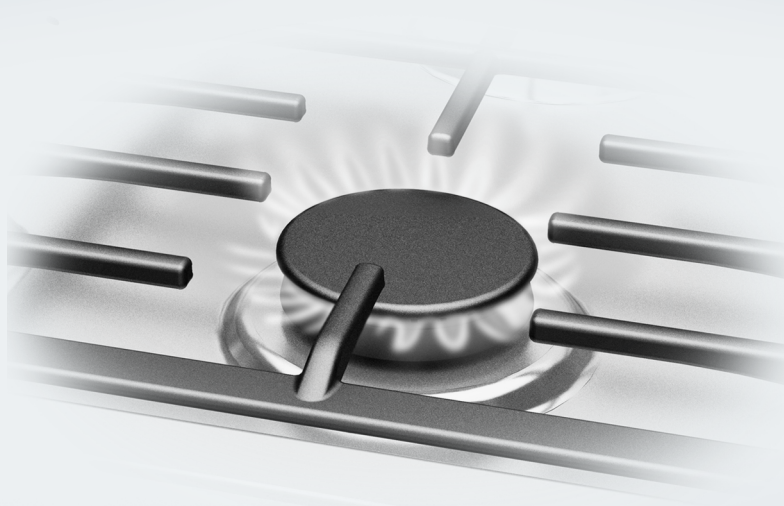

To prevent accidents and damage to the range, you **must** read all instructions supplied before installing or using the appliance.

# IMPORTANT SAFETY INSTRUCTIONS

## WARNING

Children and adults can tip over the range if has not been secured. This may lead to fatal injuries.

- ▶ This range must be secured and connected using the anti-tip device according to the installation instructions.
- ▶ If you have moved the range, slide the locking latch onto the anti-tip device until you feel it lock into place.
- ▶ Do not use the range if the anti-tip device has not been properly installed and engaged.
- ▶ Failure to observe the information contained in the installation instructions can lead to serious or fatal injuries for children and adults.

	<b> WARNING</b>
	<p>All ranges can tip</p> <p>Injury to persons could result</p> <p>Install anti-tip devices packed with range</p> <p>See installation instructions</p>

# IMPORTANT SAFETY INSTRUCTIONS

**⚠ WARNING:** If the information in this manual is not followed exactly, a fire or explosion may result causing property damage, personal injury, or death.

- Do not use or store gasoline or other combustible liquids or vapors in the vicinity of this or any other appliance.
- WHAT TO DO IF YOU SMELL GAS
  - Do not try to light any appliance.
  - Do not touch any electric switches.
  - Do not use any phones inside your building.
  - Immediately call your gas supplier from a neighbor's phone. Follow the gas supplier's instructions.
  - If you are unable to reach your gas provider, call the fire department.
- Installation and service must be performed by a qualified installer, qualified service agency or your gas provider.  
(In Massachusetts, installation must be performed by a licensed installer / gas fitter.)
- Note to the installer:  
Please give these installation instructions to the consumer for the local electrical/gas inspector.



# Contents

---

<b>IMPORTANT SAFETY INSTRUCTIONS</b> .....	2
<b>IMPORTANT SAFETY INSTRUCTIONS</b> .....	6
<b>Guide to the range</b> .....	16
HR 1124 .....	16
Cooktop .....	16
Controls .....	17
HR 1134 .....	18
Cooktop .....	18
Controls .....	19
HR 1135 .....	20
Cooktop .....	20
Controls .....	21
HR 1136 .....	22
Cooktop .....	22
Controls .....	23
HR 1924 .....	24
Cooktop .....	24
Controls .....	25
HR 1934 .....	26
Cooktop .....	26
Controls .....	27
HR 1935 .....	28
Cooktop .....	28
Controls .....	29
HR 1936 .....	30
Cooktop .....	30
Controls .....	31
HR 1954 .....	32
Cooktop .....	32
Controls .....	33
HR 1955 .....	34
Cooktop .....	34
Controls .....	35
HR 1956 .....	36
Cooktop .....	36
Controls .....	37
<b>Control panel</b> .....	38
Burner knob .....	38

# Contents

<b>Features</b> .....	39
Model numbers .....	39
Data plate .....	39
Items included with this range .....	39
Cooktop safety feature .....	39
Automatic re-ignition.....	39
<b>Before using for the first time</b> .....	40
Cleaning the cooktop for the first time .....	40
"Burning in" the griddle plate.....	40
<b>Operating the cooktop</b> .....	41
Turning on .....	41
Switching on during a power outage .....	41
Adjusting the flame .....	41
Visual characteristics gas flames.....	42
Turning off .....	42
<b>Cookware</b> .....	44
<b>Energy saving tips</b> .....	45
<b>Operating the grill</b> .....	46
Assembling the grill.....	46
Turning on the grill.....	47
Grilling tips .....	47
<b>Operation of the griddle</b> .....	48
Turning on the griddle .....	48
Settings .....	48
Tips for frying .....	49
<b>Cleaning and care</b> .....	50
Gas cooktop .....	51
Dishwasher-safe grates .....	51
Burner control knobs with stainless steel finish.....	51
Simmer burner / Power burners .....	51
Cleaning the grill grate .....	52
Cleaning the griddle plate.....	52
<b>Frequently asked questions</b> .....	53
<b>Technical Service</b> .....	55

# IMPORTANT SAFETY INSTRUCTIONS

---

**When using the appliance, follow basic safety precautions, including the following:**

**Read all instructions before installation and use of the range to prevent accidents and machine damage.**

This cooktop conforms to current safety requirements. Improper use can, however, lead to personal injury and damage to property.

To avoid the risk of accidents and damage to the appliance, please read these instructions carefully before using the appliance for the first time. They contain important notes on installation, safety, use and maintenance.

Miele cannot be held liable for damage occurring as a result of non-compliance with these instructions.

Keep these instructions in a safe place and pass them on to any future owners.

# IMPORTANT SAFETY INSTRUCTIONS

---

## Use

- ▶ This cooktop is intended for domestic use and use in other similar environments.
- ▶ This cooktop is not intended for outdoor use.
- ▶ The cooktop is intended for domestic use only to prepare food and keep it warm. Any other use may be dangerous.
- ▶ Persons who lack physical, sensory or mental abilities, or experience with the appliance should not use it without supervision or instruction by a responsible person.

# IMPORTANT SAFETY INSTRUCTIONS

---

## Children

- ▶ As with any appliance, close supervision is necessary when used by children.
- ▶ Do not leave children unattended: Children should not be alone or unsupervised in the area where the oven is installed. Do not allow them to sit or stand on the appliance.
- ▶ Children under eight years of age must be kept away from the cooktop unless they are constantly supervised.
- ▶ Children ages eight and up may only use the cooktop without supervision if they have been shown how to use it in a safe manner, and if they are able to recognize and understand the potential risks of improper use.
- ▶ Children must not be allowed to clean the cooktop without supervision.
- ▶ Be sure to supervise any children in the vicinity of the cooktop, and do not let them play with it.
- ▶ The cooktop gets hot when in use and remains hot for some time after being turned off. Keep children away from the appliance until it has cooled down and is no longer a burn hazard.
- ▶ Danger of suffocation! Ensure that any plastic wrappings, bags, etc. are disposed of safely and kept out of the reach of children.
- ▶ Burn hazard!  
Keep the spaces above and behind the range clear of any items that could draw the attention of children. Otherwise, they can be tempted into climbing onto the appliance.
- ▶ Danger of burning or scalding!  
Turn all handles away from the front of the cooktop so that children cannot pull pots and pans down and burn themselves.



# IMPORTANT SAFETY INSTRUCTIONS

---

## Technical safety

- ▶ Installation, repair and maintenance work should be performed by a Miele authorized service technician in accordance with national and local safety regulations and the provided installation instructions. Contact Miele's Technical Service Department for examination, repair or adjustment. Repairs and other work by unauthorized persons could be dangerous and may void the warranty.
- ▶ Do not carry or lift the range by the oven door handle or the control panel!
- ▶ Maintenance by the user: Never repair or replace any part of the appliance unless the instructions specifically recommend doing so. Service work may only be performed by a qualified technician.
- ▶ A damaged cooktop can be dangerous. Always check for visible signs of damage. Never use a damaged appliance.
- ▶ Reliable and safe operation of the cooktop can only be guaranteed if it is connected to the public power supply.
- ▶ The electrical safety of the range can only be guaranteed when it is properly grounded. Compliance with this essential safety requirement is absolutely mandatory. If in any doubt, please have the building's wiring system inspected by a qualified electrician.
- ▶ Proper installation: Make sure that your appliance has been installed correctly and that it has been grounded by a qualified technician.
- ▶ For safety reasons, the cooktop may only be used when it has been fully installed.
- ▶ To avoid damaging the range, make sure that the connection data (voltage and frequency) on the data plate correspond to the building's power supply before connecting the appliance. When in doubt, consult a qualified electrician.

## IMPORTANT SAFETY INSTRUCTIONS

---

- ▶ Installation and maintenance of the gas connection must be performed by qualified installers, service agencies or gas providers.
- ▶ Do not use a power strip or extension cord to connect the range to electricity. These are a fire hazard and do not guarantee the required level of appliance safety.
- ▶ This appliance must not be installed and operated in mobile installations (e.g. on a ship).
- ▶ Any contact with live connections or tampering with the electrical or mechanical components of the cooktop will endanger your safety and may lead to appliance malfunctions.  
Do not open the casing of the cooktop under any circumstances.
- ▶ Any repairs not performed by a Miele authorized service technician will void the warranty.
- ▶ Defective components should be replaced by Miele original parts only. Only with these parts can the manufacturer guarantee the safety of the appliance.
- ▶ During installation, maintenance and repair work, e.g. if the oven lighting is broken (see "Frequently asked questions"), the range must be completely disconnected from the household electricity supply. The gas supply must be shut off. Ensure that this is the case by:
  - removing the fuse,
  - "tripping" the circuit breaker, or
  - unplugging the unit. Pull the plug not the cord.
  - Shut off the gas supply and, if necessary, disconnect the range from the gas line. Installation and maintenance of the gas connection must be performed by qualified installers, service agencies or gas providers.
- ▶ Risk of electric shock!  
If the cooktop is defective, immediately turn the appliance off and discontinue use. Disconnect the range from the gas and power supply and contact Miele.

## IMPORTANT SAFETY INSTRUCTIONS

---

- ▶ If the range is installed behind a cabinet door, do not close the door while the appliance is in operation. Heat and moisture can build up behind the closed door and cause damage to the range and to the surrounding cabinets and flooring. Do not close the door until the appliance has completely cooled down.
- ▶ Do not install kitchen cabinets above the range, since reaching over a hot stovetop to access the cabinets can result in burns. If it is necessary to install cabinets, you can reduce the risk of burns by installing a range hood that extends at least 4 3/4" (12 cm) past the bottom of the cabinets.

# IMPORTANT SAFETY INSTRUCTIONS

---

## Proper use

- ▶ Do not leave the cooktop unattended when cooking on high power. Spilled food will begin to smoke and cause grease splatter, which can ignite on the cooktop.
- ▶ Oil and fat can catch fire if overheated. Never leave the appliance unattended when cooking with oil and fat. If the oil or fat catches fire, do not attempt to put the flames out with water. Turn off the cooktop and smother the flames using a lid or a suitable fire blanket.
- ▶ Smother the fire or flames, or use a dry chemical extinguishing agent or foam fire extinguisher.
- ▶ Never store flammable liquids and materials in, above or under an oven, or near cooking surfaces.
- ▶ The flames could set the grease filters of a ventilation hood on fire. Do not flambé under a ventilation hood.
- ▶ Never heat empty cookware.
- ▶ Do not heat or can food in closed containers, such as tins or sealed jars, on the cooktop, as pressure will build up in the container and cause it to explode.
- ▶ If the cooktop is covered, there is a risk that the material of the cover will ignite, explode or melt if the range is still hot or if turned on inadvertently. Never cover the cooktop with a board, cloth or protective sheet.
- ▶ When using an electrical appliance, e.g. a hand mixer, near the cooktop, make sure that the power cable does not come into contact with the hot cooktop. The cable's insulation could become damaged.
- ▶ Cookware made of plastic or aluminum foil will melt at high temperatures. Do not use any plastic or aluminum foil cookware.

## IMPORTANT SAFETY INSTRUCTIONS

---

- ▶ The cooktop gets hot when in use and remains hot for some time after being turned off. Do not touch the appliance if there is a possibility that it could still be hot.
- ▶ You can burn yourself on a hot cooktop. When cooking on the appliance, protect your hands by using heat-resistant pot holders or oven mitts. Only use dry pot holders or gloves. Wet or damp textiles conduct heat more effectively and produce steam, which poses a burn hazard. Be sure to keep all textiles away from the gas flames. Do not use oversized cloths, dish towels or other similar materials.
- ▶ If the cooktop is accidentally turned on or is still hot, metal objects on the appliance can heat up. Other items may melt or catch fire. Do not place unused items on the cooktop for storage!
- ▶ A range hood installed above the cooktop can become damaged or catch fire as a result of intense heat. Do not use the gas burners without cookware.
- ▶ When in use, the cooktop emits a significant amount of heat, which can cause objects in the vicinity to catch fire. Never use the cooktop to heat the room.
- ▶ Only light the gas burners after all burner parts have been properly assembled.
- ▶ If the cookware is too small, it will not sit properly on the burner grate. If the cookware is too large, heat emitted from the bottom of the cookware may damage the countertop, walls with poor heat-resistance (e.g. paneled walls) or portions of the cooktop.
- ▶ Make sure that the burner flames do not extend beyond the bottom of the cookware and rise up its sides.
- ▶ Only use cookware with a thick enough bottom. Failure to do so may result in damage to the cooktop.
- ▶ Always use the burner grates supplied with the cooktop. Never place cookware directly on the burner.

## IMPORTANT SAFETY INSTRUCTIONS

---

- ▶ Remove all grease splatters and other flammable (food) residues on the cooktop. They are a fire hazard.
- ▶ Install the burner grates in an upright position to avoid scratching the cooktop.
- ▶ Do not use roasting dishes, pans, or grilling stones that are large enough to cover several burners. The resulting heat buildup can damage the appliance.
- ▶ If the cooktop has not been used for a long period of time, be sure to thoroughly clean it and have it inspected by an authorized technician before using it again.
- ▶ The use of the cooktop creates heat, moisture and combustion products in the room where it is installed. Make sure that the appliance is installed in location with sufficient ventilation. Natural ventilation openings should not be blocked. Alternatively, a mechanical ventilation device (e.g. a range hood) can be installed.
- ▶ Prolonged intensive use of the appliance may require additional ventilation of the room, e.g., by opening a window, or by turning the range hood to a higher setting.
- ▶ Ask your installer to show you the location of your gas shutoff valve and fuses or circuit breaker panel in your apartment or home. Be sure that you know how and where to disconnect the gas and power supply to your cooktop.
- ▶ Ensure that the igniters are clean and dry to allow the burners to ignite and burn properly.
- ▶ Fire hazard! Loose-fitting or hanging garments can catch fire. Be sure to wear appropriately fitting clothing when cooking. Never allow loose clothing or flammable materials to come into contact with the burners while the burners are in use.
- ▶ When you have finished cooking, make sure that the burners and oven are turned off by checking the position of the knobs.

## IMPORTANT SAFETY INSTRUCTIONS

---

- ▶ The grates, burner cap, bottom parts of the burner, and any other parts located near the burner flame, can still be very hot after cooking and cause burns. Do not touch these components when using the cooktop.
- ▶ Wind can blow curtains over the cooktop, causing them to catch fire. If the cooktop is installed near a window, do not use long curtains.
- ▶ Only certain types of glass, ceramic or other enamel cookware can be used on a gas cooktop without breaking as a result of sudden temperature changes.
- ▶ Do not use cooking utensils on the grill.
- ▶ Wet sponges or clothes can cause burns due to hot steam if they are used to wipe spilled food off a hot burner. Some cleansers can emit hazardous vapors if they are applied to a hot surface. Be careful when cleaning the cooktop.

### **Cleaning and care**

- ▶ Do not use a steam cleaner to clean the cooktop. The steam may reach electrical components and cause a short circuit.

**SAVE THESE INSTRUCTIONS AND REVIEW THEM PERIODICALLY**

# Guide to the range

---

## HR 1124

### Cooktop

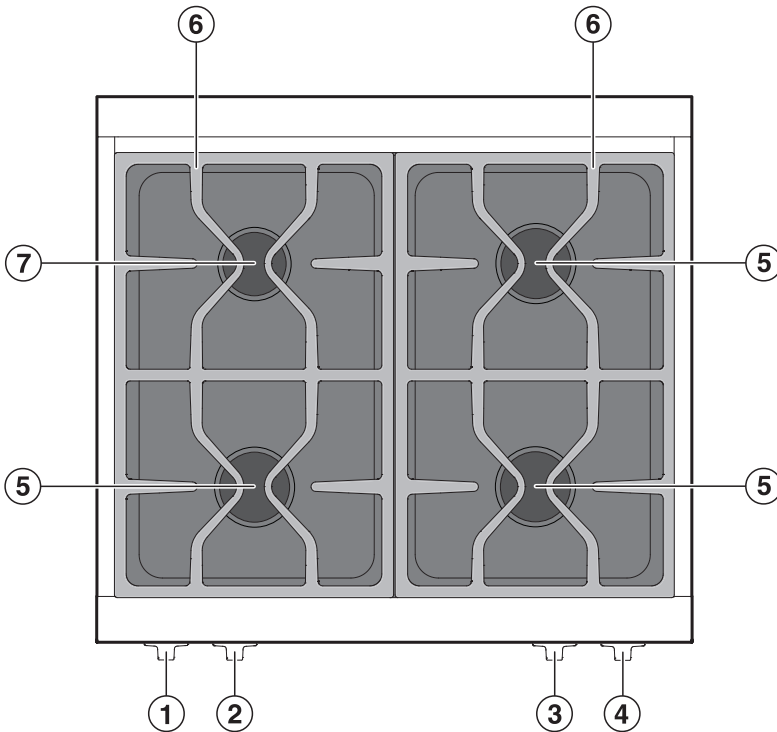

- ① Burner knob for rear left burner
- ② Burner knob for front left burner
- ③ Burner knob for front right burner
- ④ Burner knob for rear right burner
- ⑤ Power burners
- ⑥ Dishwasher-safe grates
- ⑦ Slimmer burner



## Controls

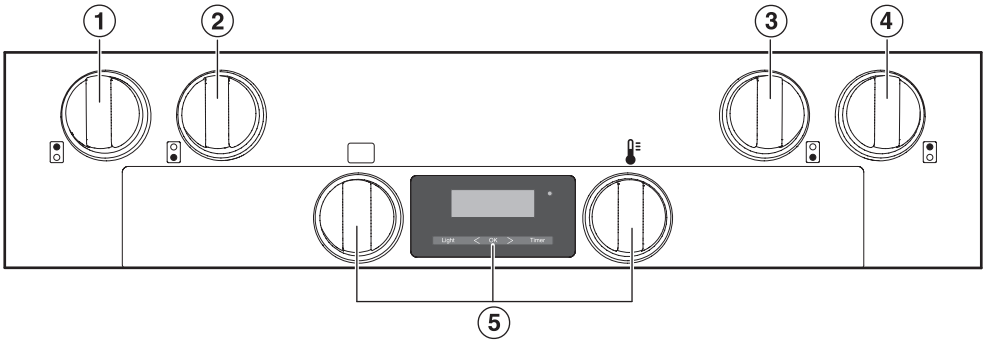

- ① Burner knob for rear left burner
- ② Burner knob for front left burner
- ③ Burner knob for front right burner
- ④ Burner knob for rear right burner
- ⑤ Oven controls

# Guide to the range

---

## HR 1134

### Cooktop

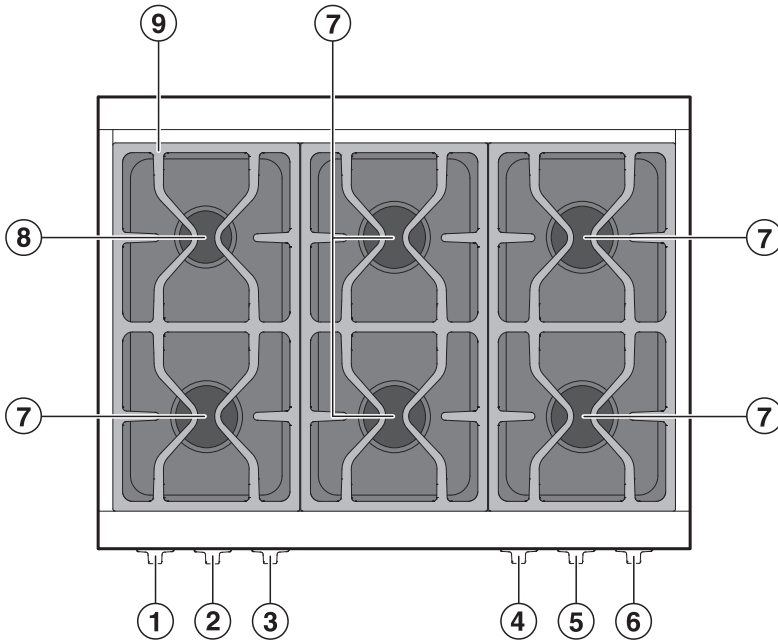

- ① Burner knob for rear left burner
- ② Burner knob for front left burner
- ③ Burner knob for front center burner
- ④ Burner knob for rear center burner
- ⑤ Burner knob for front right burner
- ⑥ Burner knob for rear right burner
- ⑦ Power burners
- ⑧ Slimmer burner
- ⑨ Dishwasher-safe grates

## Controls

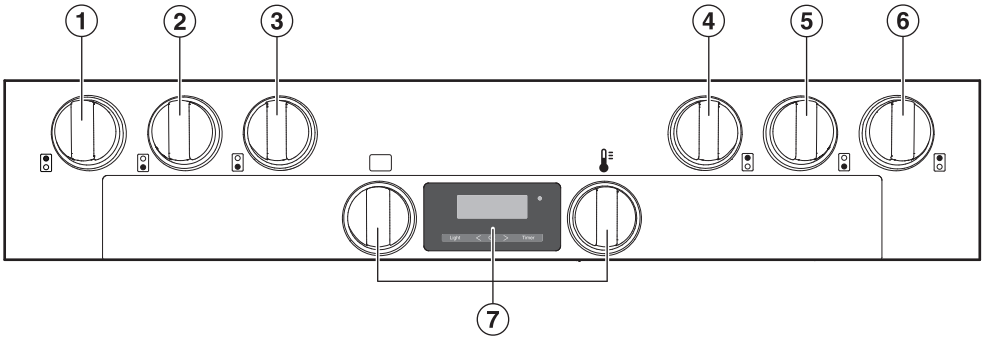

- ① Burner knob for rear left burner
- ② Burner knob for front left burner
- ③ Burner knob for front center burner
- ④ Burner knob for rear center burner
- ⑤ Burner knob for front right burner
- ⑥ Burner knob for rear right burner
- ⑦ Oven controls

# Guide to the range

---

## HR 1135

### Cooktop

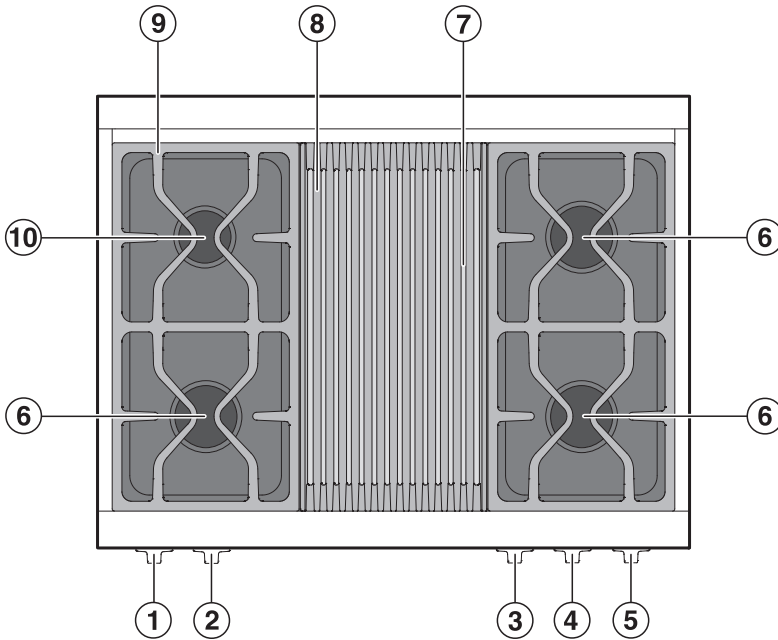

- ① Burner knob for rear left burner
- ② Burner knob for front left burner
- ③ Grill control knob
- ④ Burner knob for front right burner
- ⑤ Burner knob for rear right burner
- ⑥ Power burners
- ⑦ Thermostatically controlled ceramic burners
- ⑧ Dishwasher-safe grill grate
- ⑨ Dishwasher-safe grates
- ⑩ Slimmer burner

## Controls

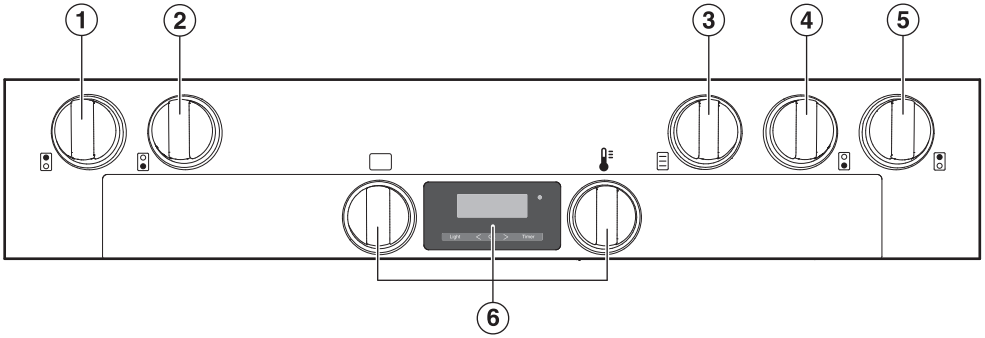

- ① Burner knob for rear left burner
- ② Burner knob for front left burner
- ③ Grill control knob

- ④ Burner knob for front right burner
- ⑤ Burner knob for rear right burner
- ⑥ Oven controls

# Guide to the range

---

## HR 1136

### Cooktop

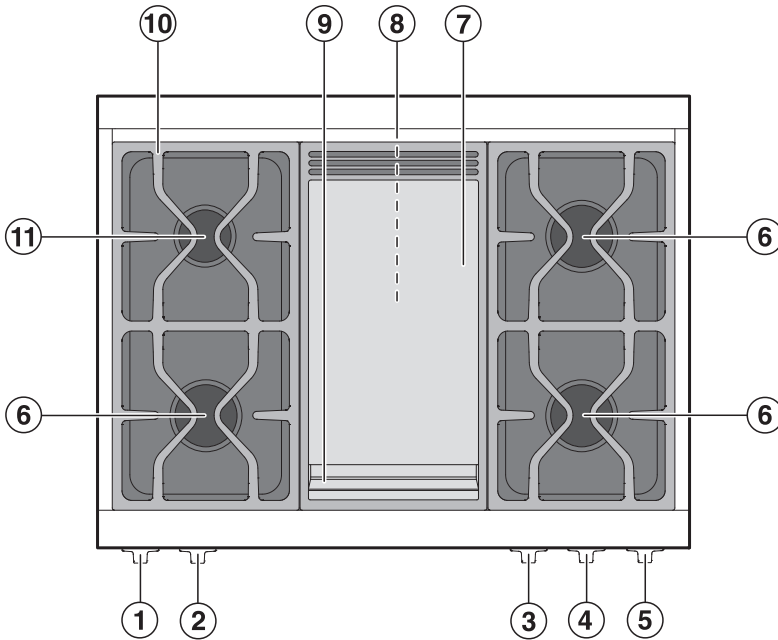

- ① Burner knob for rear left burner
- ② Burner knob for front left burner
- ③ Control knob for griddle plate
- ④ Burner knob for front right burner
- ⑤ Burner knob for rear right burner
- ⑥ Power burners
- ⑦ Griddle plate
- ⑧ Thermostatically controlled ceramic burners
- ⑨ Dishwasher-safe stainless steel grease drip tray
- ⑩ Dishwasher-safe grates
- ⑪ Slimmer burner

## Controls

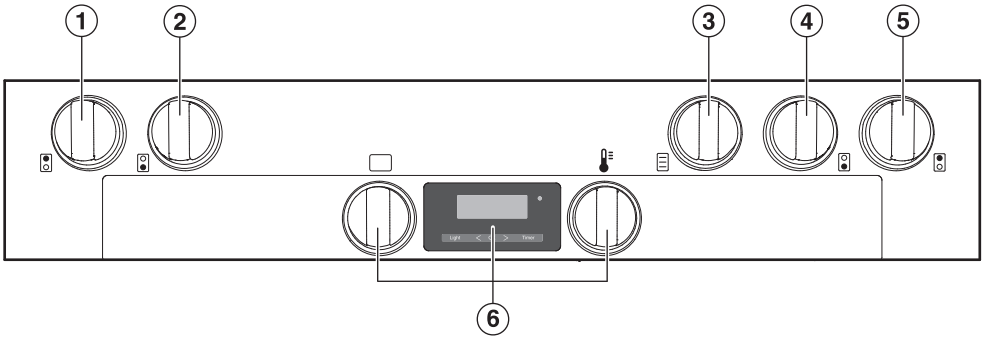

- ① Burner knob for rear left burner
- ② Burner knob for front left burner
- ③ Control knob for griddle plate

- ④ Burner knob for front right burner
- ⑤ Burner knob for rear right burner
- ⑥ Oven controls

# Guide to the range

---

## HR 1924

### Cooktop

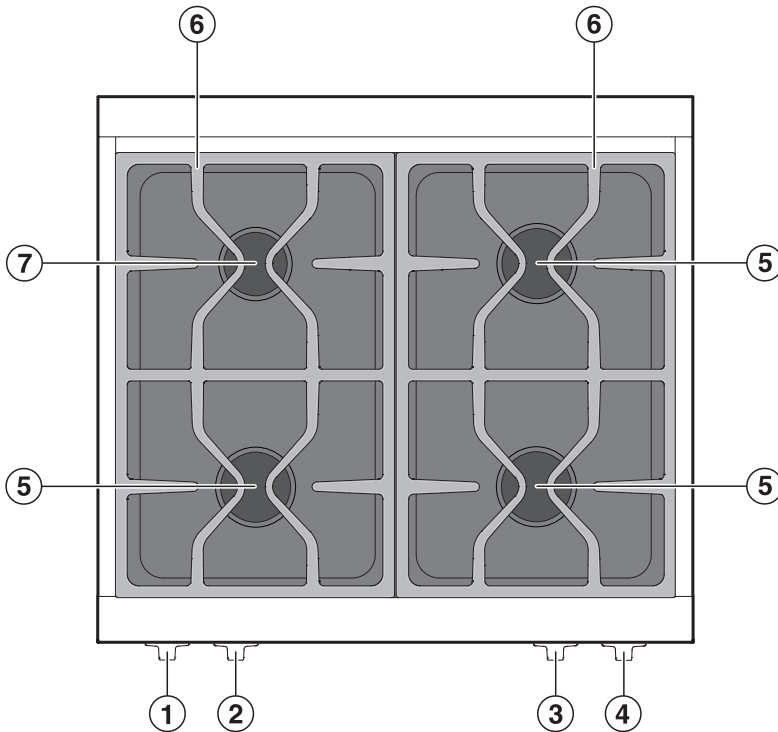

- ① Backlit burner control knob for rear left burner
- ② Backlit burner control knob for front left burner
- ③ Backlit burner control knob for front right burner
- ④ Backlit burner control knob for rear right burner
- ⑤ Power burners
- ⑥ Dishwasher-safe grates
- ⑦ Simmer burner



## Controls

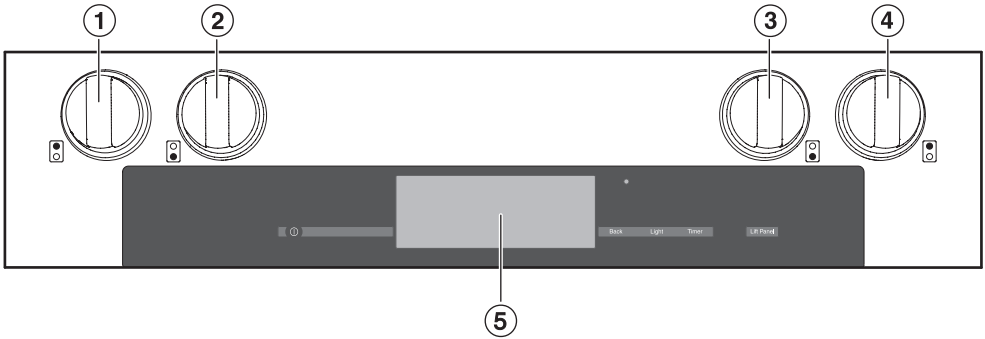

- ① Backlit burner control knob for rear left burner
- ② Backlit burner control knob for front left burner
- ③ Backlit burner control knob for front right burner
- ④ Backlit burner control knob for rear right burner
- ⑤ Oven controls

# Guide to the range

---

## HR 1934

### Cooktop

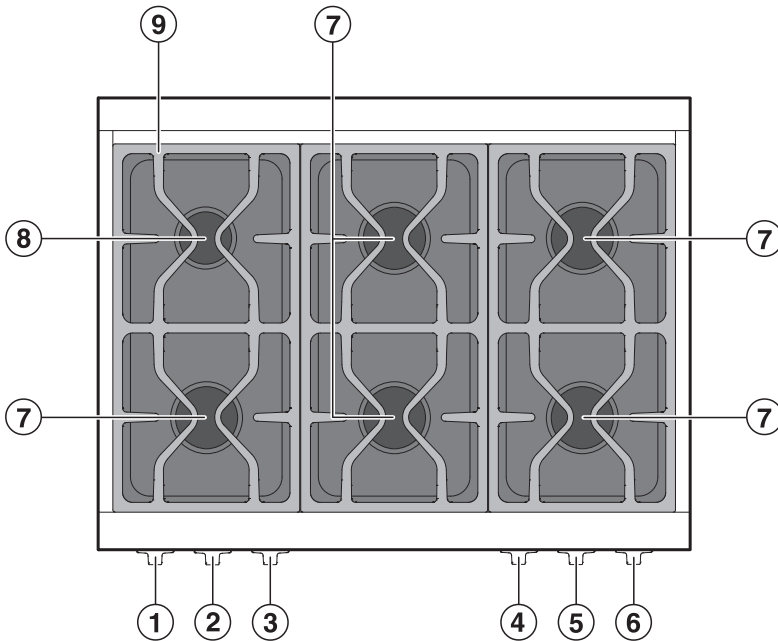

- ① Backlit burner control knob for rear left burner
- ② Backlit burner control knob for front left burner
- ③ Backlit burner control knob for front center burner
- ④ Backlit burner control knob for rear center burner
- ⑤ Backlit burner control knob for front right burner
- ⑥ Backlit burner control knob for rear right burner
- ⑦ Power burners
- ⑧ Slimmer burner
- ⑨ Dishwasher-safe grates

## Controls

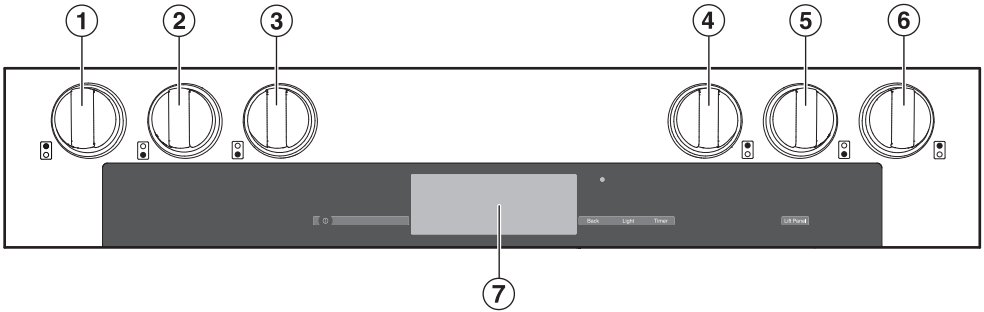

- ① Backlit burner control knob for rear left burner
- ② Backlit burner control knob for front left burner
- ③ Backlit burner control knob for front center burner
- ④ Backlit burner control knob for rear center burner
- ⑤ Backlit burner control knob for front right burner
- ⑥ Backlit burner control knob for rear right burner
- ⑦ Oven controls

# Guide to the range

---

## HR 1935

### Cooktop

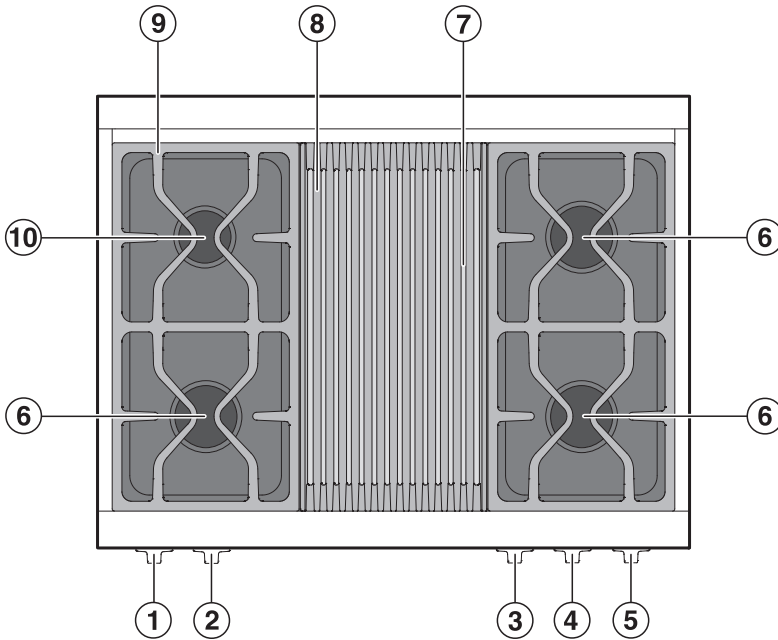

- ① Backlit burner control knob for rear left burner
- ② Backlit burner control knob for front left burner
- ③ Backlit control knob for the grill
- ④ Backlit burner control knob for front right burner
- ⑤ Backlit burner control knob for rear right burner
- ⑥ Power burners
- ⑦ Thermostatically controlled ceramic burners
- ⑧ Dishwasher-safe grill grate
- ⑨ Dishwasher-safe grates
- ⑩ Slimmer burner

## Controls

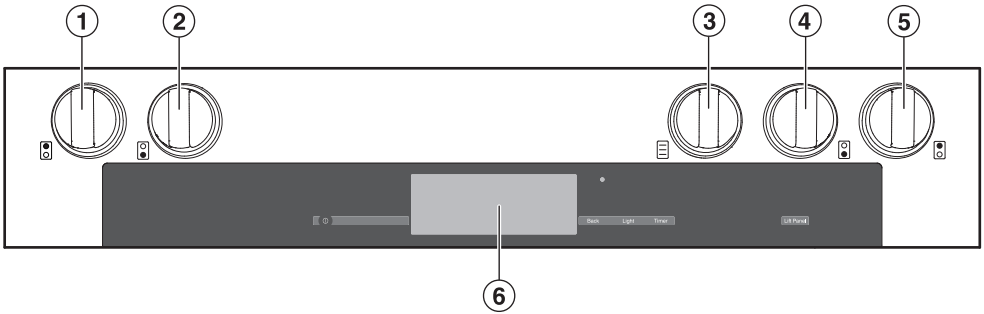

- ① Backlit burner control knob for rear left burner
- ② Backlit burner control knob for front left burner
- ③ Backlit control knob for the grill
- ④ Backlit burner control knob for front right burner
- ⑤ Backlit burner control knob for rear right burner
- ⑥ Oven controls

# Guide to the range

## HR 1936

### Cooktop

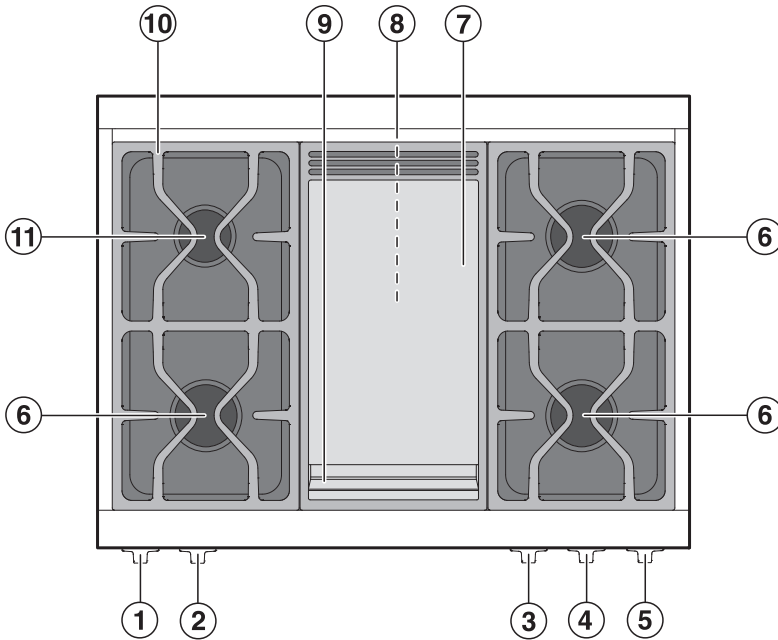

- ① Backlit burner control knob for rear left burner
- ② Backlit burner control knob for front left burner
- ③ Backlit burner control knob for griddle plate
- ④ Backlit burner control knob for front right burner
- ⑤ Backlit burner control knob for rear right burner
- ⑥ Power burners
- ⑦ Griddle plate
- ⑧ Thermostatically controlled ceramic burners
- ⑨ Dishwasher-safe stainless steel grease drip tray
- ⑩ Dishwasher-safe grates
- ⑪ Slimmer burner

## Controls

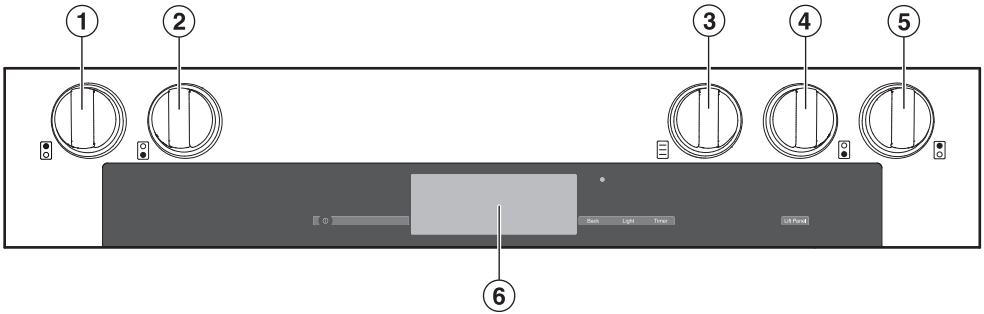

- ① Backlit burner control knob for rear left burner
- ② Backlit burner control knob for front left burner
- ③ Backlit burner control knob for griddle plate
- ④ Backlit burner control knob for front right burner
- ⑤ Backlit burner control knob for rear right burner
- ⑥ Oven controls

# Guide to the range

## HR 1954

### Cooktop

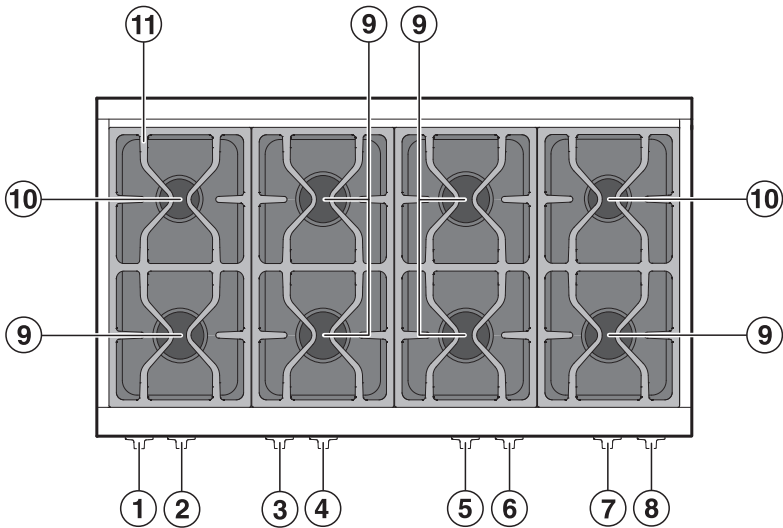

- ① Backlit burner control knob for rear left burner
- ② Backlit burner control knob for front left burner
- ③ Backlit burner control knob for rear left center burner
- ④ Backlit burner control knob for front left center burner
- ⑤ Backlit burner control knob for front right center burner
- ⑥ Backlit burner control knob for rear right center burner
- ⑦ Backlit burner control knob for front right burner
- ⑧ Backlit burner control knob for rear right burner
- ⑨ Power burners
- ⑩ Slimmer burner
- ⑪ Dishwasher-safe grates



## Controls

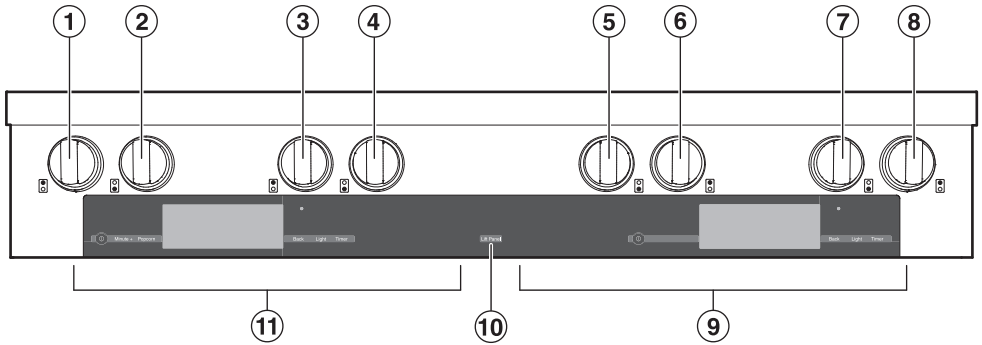

- ① Backlit burner control knob for rear left burner
- ② Backlit burner control knob for front left burner
- ③ Backlit burner control knob for rear left center burner
- ④ Backlit burner control knob for front left center burner
- ⑤ Backlit burner control knob for front right center burner
- ⑥ Backlit burner control knob for rear right center burner
- ⑦ Backlit burner control knob for front right burner
- ⑧ Backlit burner control knob for rear right burner
- ⑨ Oven controls
- ⑩ Sensor button for lift panel
- ⑪ Speed Oven controls

# Guide to the range

---

## HR 1955

### Cooktop

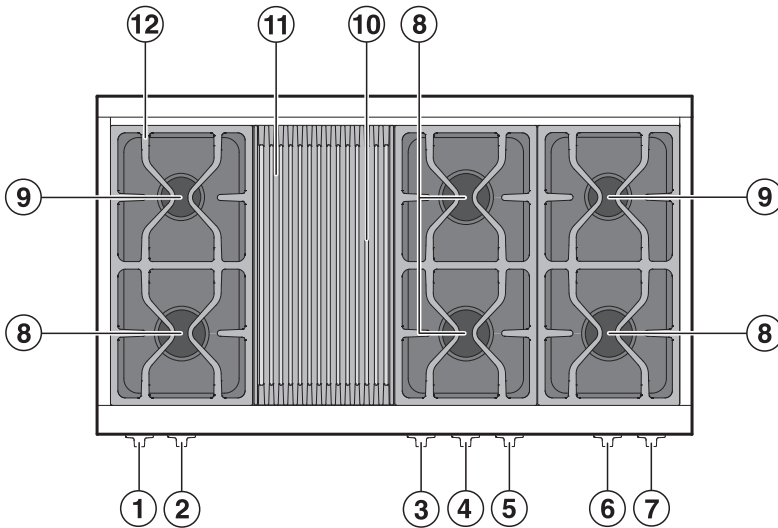

- ① Backlit burner control knob for rear left burner
- ② Backlit burner control knob for front left burner
- ③ Backlit control knob for the grill
- ④ Backlit burner control knob for front center burner
- ⑤ Backlit burner control knob for rear center burner
- ⑥ Backlit burner control knob for front right burner
- ⑦ Backlit burner control knob for rear right burner
- ⑧ Power burners
- ⑨ Slimmer burner
- ⑩ Thermostatically controlled ceramic burners
- ⑪ Dishwasher-safe grill grate
- ⑫ Dishwasher-safe grates

## Controls

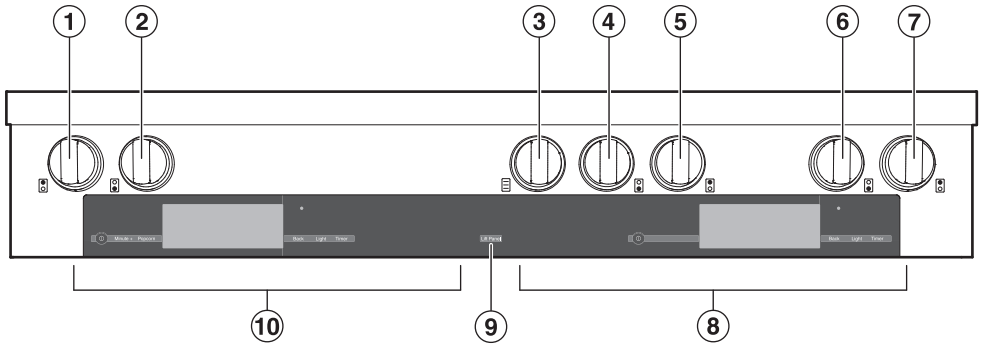

- ① Backlit burner control knob for rear left burner
- ② Backlit burner control knob for front left burner
- ③ Backlit control knob for the grill
- ④ Backlit burner control knob for front center burner
- ⑤ Backlit burner control knob for rear center burner
- ⑥ Backlit burner control knob for front right burner
- ⑦ Backlit burner control knob for rear right burner
- ⑧ Oven controls
- ⑨ Sensor button for lift panel
- ⑩ Speed Oven controls

# Guide to the range

## HR 1956

### Cooktop

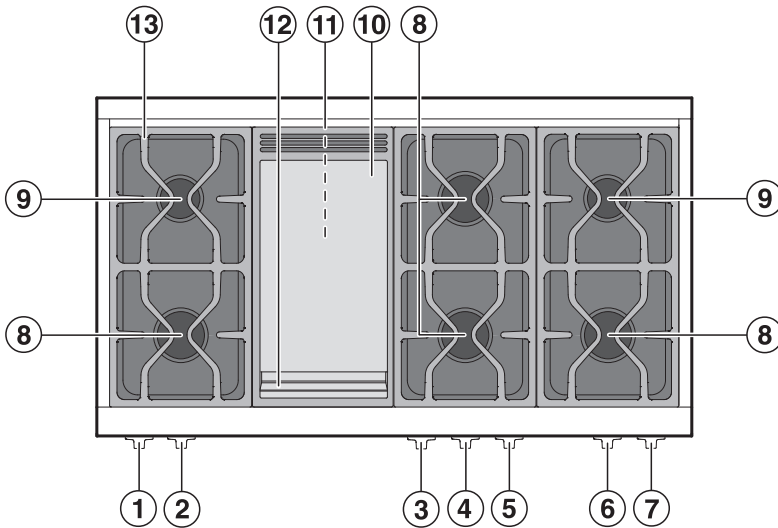

- ① Backlit burner control knob for rear left burner
- ② Backlit burner control knob for front left burner
- ③ Backlit burner control knob for griddle plate
- ④ Backlit burner control knob for front center burner
- ⑤ Backlit burner control knob for rear center burner
- ⑥ Backlit burner control knob for front right burner
- ⑦ Backlit burner control knob for rear right burner
- ⑧ Power burners
- ⑨ Slimmer burner
- ⑩ Griddle plate
- ⑪ Thermostatically controlled ceramic burners
- ⑫ Dishwasher-safe stainless steel grease drip tray
- ⑬ Dishwasher-safe grates

## Controls

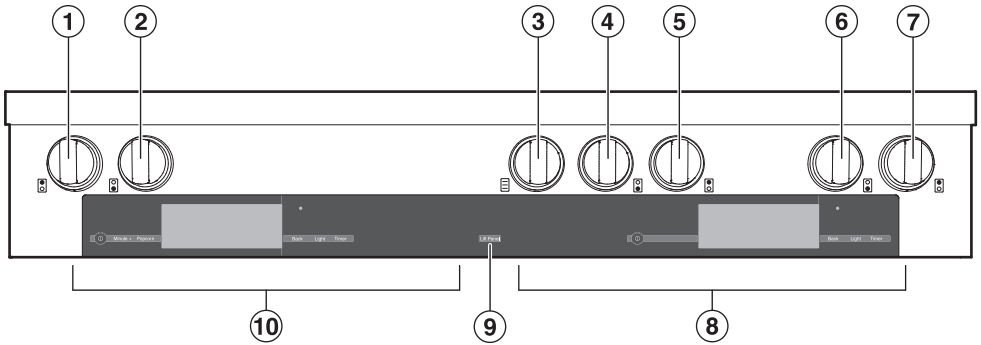

- ① Backlit burner control knob for rear left burner
- ② Backlit burner control knob for front left burner
- ③ Backlit burner control knob for griddle plate
- ④ Backlit burner control knob for front center burner
- ⑤ Backlit burner control knob for rear center burner
- ⑥ Backlit burner control knob for front right burner
- ⑦ Backlit burner control knob for rear right burner
- ⑧ Oven controls
- ⑨ Sensor button for lift panel
- ⑩ Speed Oven controls

# Control panel

---

## **Burner knob**

With the burner knob, you can ignite the burner and regulate the flame. The burners can be variably adjusted between the lowest and highest settings.

Depending on the model, the range will be equipped with Backlit burner control knobs.

## Model numbers

A list of the ovens described in these operating instructions can be found on the back page.

## Data plate

The data plate is behind the toe-kick. The toe-kick cover is attached to the base of the range by magnets so it can be removed and put back again easily.

There you can find the model number, the serial number and the connection data (voltage/frequency/maximum rated load) for your range.

Have this information available when contacting Miele Technical Service.

## Items included with this range

The following items are included with this appliance:

- Installation instructions for the range
- Multiple operating instructions (depending on the range model) for:
  - Gas Cooktop
  - Gas Oven
  - Convection Oven
  - Speed Oven
  - Warming Drawer
- An anti-tip device, including screws for fastening the range
- Various accessories

## Cooktop safety feature

### Automatic re-ignition

Your gas cooktop is equipped with an automatic re-ignition function. If the flame goes out, e.g. because food has cooked over or there has been an air draft, the flame is automatically re-ignited.

# Before using for the first time

---

## Cleaning the cooktop for the first time

- Remove any protective foil and stickers.
- Using a soft sponge, clean all removable burner parts with a solution of warm water and a small amount of liquid dish soap. Dry the parts thoroughly after cleaning and reassemble the burners (see "Cleaning and care").
- Remove the grilling grate and, using a soft sponge, clean it with a solution of warm water and a small amount of dishwashing liquid. Dry it thoroughly after cleaning.
- The griddle plate is oiled for protection against corrosion. Clean the griddle plate with a soft sponge, a small amount of dishwashing liquid, and warm water, and dry it.
- Before first use, wipe down the appliance with a damp cloth and dry it.

Metal components are protected by a conditioning agent. Smells and vapor may occur when the appliance is used for the first time.

The smell and any vapors do not indicate a faulty connection or a defective appliance and are not harmful to your health.

## "Burning in" the griddle plate

You must "burn in" the griddle plate before cooking food on it the first time. This process prevents food from sticking and protects the surface from moisture.

- Set the griddle plate on "High" for 30 minutes.
- Switch off the griddle plate after 30 minutes and let it cool down.

During heating, the griddle plate constantly changes color. The discoloration may become more intensive over time. The properties of the griddle plate, however, are not impaired in this manner.

- Pour 1 teaspoon of vegetable oil that can be heated to a high temperature in the middle of the cooled griddle plate and distribute it with a paper towel, leaving out the corners of the plate.

Do not use too much oil. Excess oil leaves a rubbery substance on the plate that has to be removed.

- Remove any excess oil with a paper towel.
- Heat the griddle plate on "High" until it starts to smoke.
- Switch off the griddle plate.
- When the griddle plate had cooled down to a hand-warm temperature, wash off the excess oil.
- Repeat the process once the griddle plate has cooled down completely.





**Fire hazard!**

Do not leave the appliance unattended while cooking!

## Turning on

Do not turn the control knob clockwise past the "Off" position.

Activating a control knob automatically produces a spark on all of the burners. This is normal and does not indicate a fault.

You may notice a brief re-ignition (1-2 clicks) when turning on the appliance, e.g. because of a draft.

- To ignite a burner, push the appropriate control knob and turn it counterclockwise to the "High" position. The ignitor "clicks" and ignites the gas.
- If the burner fails to light, turn the control knob to the "Off" position. Vent the room or wait at least 1 minute before trying again.
- If the second attempt also fails to light the burner, turn the control knob to the "Off" position and refer to the "Frequently asked questions" section.

## Switching on during a power outage



If there has been a power failure, the automatic re-ignition feature will not work properly.

Operate the cooktop only under supervision. If the burner has not ignited or the flame goes out, turn off the burner knob.

## Simmer and power burners

In case of a power failure, the flame can be ignited manually.

- Press in the burner knob and turn it counterclockwise to "High."
- Light the emerging gas/air mixture with a match.

## Grill



**Danger of injury due to the manual ignition of the ceramic burner during a power failure!**

Never operate the grill during a power failure.

- Turn off the grill control knob.

## Griddle plate

The griddle plate cannot be operated in case of a power failure.

- Turn off the control knob for the griddle plate.

## Adjusting the flame

The burners can be variably adjusted between the lowest and highest flame settings.

# Operating the cooktop

Because the edges of the flame are much hotter than its center, the flame tips should stay beneath the bottom of the cookware. Flame tips which extend beyond the sides of the cookware emit unnecessary heat into the room and can also damage cookware handles, which increases the risk of injury.

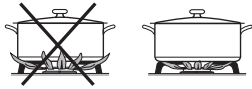

- Adjust the flame so that it never extends up the sides of the cookware.

## Visual characteristics gas flames

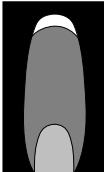
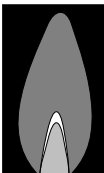
	<b>Yellow flames</b> Contact the Miele Service Department.
	<b>Yellow tips on outer cones</b> Normal for LP gas
	<b>Soft blue flames</b> yellow colour is only allowed at the tip of the inner cone Normal for natural gas

## Turning off

Do not turn the control knob clockwise past the "Off" position.

- Turn the control knob to the right until it reaches the "Off" position.

This stops the flow of gas, and the flame goes out.

## Simmer/Power burner

Knob label	Description
<b>Off</b>	Gas supply is off: Burner off
<b>High</b>	Strongest flame setting: Maximum power of upper and lower flame rings
<b>Simmer</b>	Weakest flame setting: Upper flame ring off Minimum power of lower flame ring

## Grill: Ceramic burner

According to the model, the range has a grill.

Knob label	Description
<b>Off</b>	Gas supply is off: Grill off
<b>High</b>	Maximum power
<b>Low</b>	Minimum power

## Griddle plate: Ceramic burner

According to the model, the range has a griddle.

Knob label	Description
<b>Off</b>	Gas supply is off: Griddle off
<b>Low</b>	Minimum power
<b>Medium</b>	Medium power
<b>High</b>	Maximum power

# Cookware

---

- Select cookware that fits the size of the burner:  
Large diameter = large burner  
Small diameter = small burner
- Using cookware that is too large can cause the flames to spread out and damage the surrounding countertop or other appliances. Choosing the right cookware size improves efficiency.
- Any cookware that has a diameter smaller than the burner grate or which does not rest in a stable position on the grate (without wobbling) is dangerous and should not be used.
- Unlike cookware that is used on an electric cooktop, the bottom of cookware used on a gas cooktop does not have to be flat to deliver effective cooking performance.
- When purchasing pots and pans, keep in mind that the diameter indicated is typically the top diameter, not the bottom diameter.
- All heat-resistant cookware is suitable for use on the gas cooktop.
- Cookware with a thick bottom is preferable, as it distributes heat more evenly. Cookware with a thin bottom may cause food to overheat in certain spots. To avoid this, stir the food frequently.
- Always place cookware on the burner grate supplied with the cooktop. Never place it directly on the burner.
- Position the cookware on the burner grate so that it cannot tip. There is always a possibility of a slight tilt, despite the proper position.
- Do not use pots or pans that have bottoms with pronounced edges.



- Whenever possible, keep pots and pans covered while cooking. Doing so will prevent unnecessary heat loss.

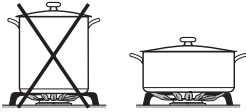

- Wide, shallow cookware heats up faster and is therefore preferable to tall, narrow cookware.
- Cook with as little water as possible.
- Reduce the power setting once the water has come to a boil or the oil/fat is hot enough for frying.
- Use a pressure cooker to reduce the cooking time.

## Operating the grill

Once you start the Self Clean program, the grill and the griddle will be turned off.

During the Self Clean program, the grill and the griddle cannot be turned on.

The grill has a ceramic burner that transfers intense heat to food, searing the outside to seal the juices. Full flexibility, depending on the food, from "Low" to "High" as power settings.

Do not use cooking utensils on the grill.

## Assembling the grill

**⚠ Burn hazard!**  
The burners must be turned off and allowed to cool completely.

**⚠ Risk of injury!**  
The cast-iron grill is heavy.  
Carry the grill carefully and place it securely on a soft base so that it lies flat.

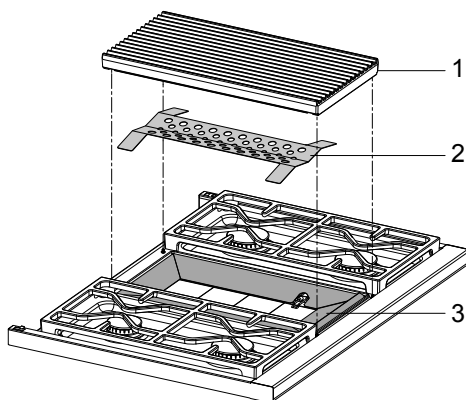

① Grill

② Grease tray

③ Frame

- Using a soft sponge, clean grease tray ② with a solution of warm water and a small amount of liquid dish soap. Dry the parts thoroughly after cleaning.
- Remove the grill ① from the gas cooktop.
- Place the grease tray ② on top of the frame ③.

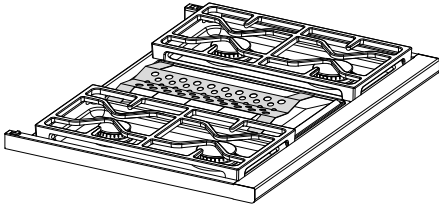

- Place the grill ① into position.

## Cleaning and care

**Tip:** All parts can be disassembled in the reverse order. You can also remove the frame for cleaning.

## Turning on the grill

- Press the control knob of the grill and turn it counterclockwise to "High."
- If the burner fails to light, turn the control knob to the "Off" position. Air the room or wait at least 1 minute before trying again.
- If the second attempt also fails to light the burner, turn the control knob to the "Off" position and refer to the "Frequently asked questions" section.
- Pre-heat the grill with the dishwasher-safe grill grate in place for approx. 20 minutes.
- Set the desired power level.

## Grilling tips

 **Fire hazard!**  
Do not leave the appliance unattended while cooking!

- Pat down wet food items with paper towel to prevent splatters during broiling.
- Do not salt meat until after broiling, or it will be too dry.
- Select lean meat or cut off fat before broiling. Dripping fat can catch on fire.
- If dripping fat catches on fire, use grilling tongs to move the meat to another spot or remove it entirely.
- Remove chicken skin to prevent sparking.
- Halfway through cooking, brush marinade onto the food.
- Leave the grill on for another 10 minutes after you have finished. In this way, it is easier to clean after cooling.

# Operation of the griddle

Once you start the Self Clean program, the grill and the griddle will be turned off.

During the Self Clean program, the grill and the griddle cannot be turned on.

The griddle is thermostatically controlled to maintain a consistent temperature. To prevent food from sticking, it is necessary to "season" the griddle prior to use (see "Before using for the first time"). Full flexibility, depending on the food, from "Low", "Medium" and "High" as power settings.

## Turning on the griddle

- Press the control knob of the griddle and turn it counterclockwise to "Low."
- If the burner fails to light, turn the control knob to the "Off" position. Air the room or wait at least 1 minute before trying again.
- If the second attempt also fails to light the burner, turn the control knob to the "Off" position and refer to the "Frequently asked questions" section.
- Preheat the griddle plate for about 20 minutes.
- Set the desired power level.

## Settings

Settings	Food
Low	Simmering Sauce
	Holding food temperature
Medium	Eggs
	Bacon
	French Toast
Medium-High	Fish
	Pancakes
	Sausage
	Hash Browns
	Vegetables
High	Burgers
	Steaks
	Stir-fry



## Tips for frying

Before each use, wipe the griddle with a damp cloth to remove dust or other residue.

- Pre-heat the griddle plate thoroughly for 8 -10 minutes at the power level that you are going to be using for cooking.
- Pat down wet food items with paper towel to prevent splatters during grilling.
- Do not salt meat until after grilling, or it will be too dry.
- For cooking with the griddle plate, you need only a little fat or none in the case of marinated food. If you use cooking fat, do not put it on the griddle plate until it is hot.
- Only use fats/oils that can tolerate high temperatures.
- Marinating often improves the flavor of food to be cooked.

## Cleaning and care

---



### Burn hazard!

The burners must be turned off and allowed to cool completely.



### Risk of injury!

The steam from a steam cleaner could reach electrical components and cause a short circuit.

Do not use a steam cleaner to clean the cooktop.

All cooktop surfaces can become discolored or damaged if unsuitable cleaning agents are used.

The outer surfaces of the cooktop are susceptible to scratching.

Immediately remove any residues left by cleaning agents.

Always clean the cooktop after each use. Allow it to cool down before cleaning.

To avoid damaging the surfaces of your appliance, do not use:

- Cleaners containing soda, ammonia, acids or chlorides
- Lime removers
- Stain or rust removers
- Abrasive cleaning agents (e.g., powder or cream cleansers, pumice stones)
- Solvent-based cleaners
- Dishwasher cleaner
- Grill and oven sprays
- Glass cleaners
- Hard, abrasive brushes or sponges (e.g. pot scrubbers or scrub sponges, sponges which have previously been used with abrasive cleaning agents)
- Sharp objects (these could damage the seals between the ceramic and the frame or between the frame and the countertop).

## Gas cooktop

The surfaces of the burner components and grates will slightly lose their luster over time. This is completely normal and does not indicate damage to the material.

- Clean the cooktop after each use with a soft sponge, warm water and a small amount of liquid dish soap.
- Pre-soak any stubborn dirt or grime before cleaning.
- Dry the appliance after using water to clean it. This helps prevent lime deposits.

**Tip:** Food that has cooked over onto a hot cooktop can cause the burner components to become discolored. Immediately remove all spilled food and all salt or sugar splatters!

### Dishwasher-safe grates

- Remove the burner grates.
- Clean the grates in the dishwasher or using a soft sponge with warm water and a small amount of liquid dish soap.
- If necessary, the rough side of a kitchen sponge can be used.

## Burner control knobs with stainless steel finish

The burner control knobs may become discolored if they are not cleaned regularly.

Do not clean the burner control knobs in a dishwasher or with a stainless steel cleaner.

Clean the knobs with a soft sponge, warm water and a small amount of liquid dish soap.

## Simmer burner / Power burners

The burner cap is not dishwasher-safe.

Make sure that the flame holes are completely dry after cleaning.

- Remove the burner cap.
- Clean the burner cap using a soft sponge, warm water and a small amount of liquid dish soap.
- All parts of the burner which cannot be removed should be wiped down with a damp cloth.

## Ignitor

Do not allow the ignitor to become wet. If it is wet, it will not spark.

- Gently wipe down the ignitor clean using a damp cloth.

# Cleaning and care

---

## Cleaning the dishwasher-safe grill grate

- Clean the grill grate in the dishwasher or with warm water and liquid dish soap. When the grill grate is strongly soiled, soak it and then remove the soiling with a brush. After that, let the grate dry thoroughly.

## Cleaning the griddle plate

 Burn hazard!

Allow the griddle plate to cool down sufficiently before cleaning it.

 Fire hazard!

Clean the grease catch pan after every use of the griddle plate.

- Loosen coarse soiling immediately with a spatula and scratch grease and residue into the grease catch pan.
- Remove any excess grease with a paper towel.
- Then let the griddle plate cool until it is safe to the touch, add some hot, soapy dishwater, and let the grime soak.
- Remove any soiling and water with asponge.

You can clean stubborn soiling off the griddle plate with the rough side of a dish sponge and a few drops of Miele ceramic and stainless steel cleaner (see "Optional accessories").

- Remove the grease catch pan and empty it.

- Clean the grease catch pan with a soft sponge, dishwashing liquid, and warm water. Dry it thoroughly after cleaning.
- Wipe off the griddle plate with clean water and dry it with a clean, dry cloth.
- Rub some vegetable oil into the griddle plate after every cleaning.
- Put the grease catch pan back into place.

## Frequently asked questions

The following guide is intended to help you resolve problems that occur during normal operation of the appliance.

If you are unable to identify or remedy the cause of the problem on your own, please contact Miele Service (see back cover for details).

 Risk of injury! Improperly performed installation, maintenance or repair work can pose a serious danger to users of the appliance.

Installation, maintenance and repairs may only be carried out by Miele authorized technicians.

Do not attempt to open the cooktop casing yourself.

Problem	Possible cause and solution
<b>The burners do not ignite when the cooktop is being used for the first time or after it has been out of use for a longer period.</b>	<p>There may be air in the gas line.</p> <ul style="list-style-type: none"> <li>■ Try to light the burner again, making several attempts if necessary.</li> </ul>
<b>The burner does not light after several attempts.</b>	<p>The burner is not properly assembled.</p> <ul style="list-style-type: none"> <li>■ Assemble the burner correctly.</li> </ul> <p>The gas shutoff valve is closed.</p> <ul style="list-style-type: none"> <li>■ Open the gas shut-off valve.</li> </ul> <p>The burner is wet and/or dirty.</p> <ul style="list-style-type: none"> <li>■ Clean and dry the burner.</li> </ul> <p>The flame holes are clogged and/or wet.</p> <ul style="list-style-type: none"> <li>■ Clean and dry the flame holes.</li> </ul>
<b>The gas flame goes out after being lit.</b>	<p>The burner parts are not in the proper position.</p> <ul style="list-style-type: none"> <li>■ Position the burner parts correctly.</li> </ul> <p>The ignitor is dirty.</p> <ul style="list-style-type: none"> <li>■ Remove any dirt or grime.</li> </ul>
<b>The shape/color of the gas flame changes.</b>	<p>The burner parts are not in the proper position.</p> <ul style="list-style-type: none"> <li>■ Position the burner parts correctly.</li> </ul> <p>The burner cap itself or the holes in the burner cap are dirty.</p> <ul style="list-style-type: none"> <li>■ Remove any dirt or grime.</li> </ul>
<b>The gas flame goes out during use.</b>	<p>The burner parts are not in the proper position.</p> <ul style="list-style-type: none"> <li>■ Position the burner parts correctly.</li> </ul>

## Frequently asked questions

Problem	Possible cause and solution
<p><b>The ignitor does not function properly.</b></p>	<p>The fuse in the building's wiring system was tripped.</p> <ul style="list-style-type: none"> <li>■ If necessary, contact a qualified electrician or Customer Service for assistance.</li> </ul>
	<p>There is food debris stuck between the ignitor and the burner cap.</p> <ul style="list-style-type: none"> <li>■ Remove the debris. (See "Cleaning and care" for more information.)</li> </ul>
<p><b>Grill and griddle are turned off/cannot be turned on</b></p>	<p>Once you start the self cleaning program, grill and griddle will be turned off.</p> <p>This is not an error. The Safety cut-out feature has been activated.</p> <p>At 1-minute intervals, a maximum of 5 ignition tests will be performed.</p> <ul style="list-style-type: none"> <li>■ Turn the grill and griddle control knob to the right until it reaches the "Off" position.</li> </ul> <p>At the end of the self clean program, you can turn grill and griddle on again.</p>
	<p>During the self cleaning program, grill and griddle cannot be turned on.</p> <p>This is not an error. The Safety cut-out feature has been activated.</p> <p>At 1-minute intervals, a maximum of 5 ignition tests will be performed.</p> <ul style="list-style-type: none"> <li>■ Turn the grill and griddle control knob to the right until it reaches the "Off" position.</li> </ul> <p>At the end of the self clean program, you can turn grill and griddle on again.</p>

## After sales service

In the event of a fault which you cannot easily correct yourself, please contact:

- your Miele dealer, or
- the Miele Technical Service Department.

See back cover for contact details.

Please quote the model and serial number of your appliance when contacting Miele.

You will find this information on the data plate, which is behind the toe-kick cover.

## Warranty

For further information, please refer to your warranty booklet.









Please have the model and serial number of your appliance available before contacting Technical Service.

---

# Miele

## **U.S.A.**

**Miele, Inc.**

### **National Headquarters**

9 Independence Way

Princeton, NJ 08540

Phone: 800-843-7231

609-419-9898

Fax: 609-419-4298

[www.mieleusa.com](http://www.mieleusa.com)

### **Technical Service & Support**

#### **Nationwide**

Phone: 800-999-1360

Fax: 888-586-8056

[TechnicalService@mieleusa.com](mailto:TechnicalService@mieleusa.com)

## **Canada**

**Importer**

**Miele Limited**

### **Headquarters and Miele Centre**

161 Four Valley Drive

Vaughan, ON L4K 4V8

[www.miele.ca](http://www.miele.ca)

### **Customer Care Centre**

Phone: 800-565-6435

905-532-2272

[customercare@miele.ca](mailto:customercare@miele.ca)

## **Germany**

**Manufacturer**

Miele & Cie. KG

Carl-Miele-Straße 29

33332 Gütersloh



[www.miele-shop.com](http://www.miele-shop.com)



**Miele**

All Gas: HR1124; HR1134; HR1135; HR1136; Dual Fuel: HR1924;  
HR1934; HR1935; HR1936; HR1954; HR1955; HR1956



en-US, CA

M.-Nr. 09 898 141 / 00