

Operating Instructions

Washer

PW 6068 Plus

To prevent accidents
and machine damage
read these instructions

before
installation or use.

en - US

M.-Nr. 10 196 550

Contents

IMPORTANT SAFETY INSTRUCTIONS	3
Guide to the washer	6
Control panel	6
Before using for the first time	9
Use	10
To cancel a program	15
To change a program	15
Adding/removing laundry during a wash program	15
Program guide	16
Program sequence	22
Spin speed	24
Extras	25
Timer	27
Favorites	28
Detergent	31
Cleaning and Care	34
Cleaning the washer	34
Cleaning the inlet hose filter	36
Frequently asked questions	37
A wash program cannot be started	37
General problems with the washer	38
Opening the door during a power failure or when the drain is blocked	41
After sales service	44
Installation instructions	45
Installation	46
Installation site	48
Removing the shipping struts	48
Installing the shipping struts	50
Leveling the washer	51
Water connection	53
Drainage	55
Electrical connection	56
Technical Data	57
Help to protect the environment	58
Settings 	60
Settings - Supervisor level	63

IMPORTANT SAFETY INSTRUCTIONS

 **WARNING** - To reduce the risk of fire, electric shock or injury to persons while using your appliance follow basic safety precautions, including the following:

Read all instructions before using the appliance.

▶ Check the packaging, the washer and accessories for any signs of damage. Do not use a damaged appliance.

▶ GROUNDING INSTRUCTIONS

This appliance must be grounded. In the event of malfunction or breakdown, grounding will reduce the risk of electric shock by providing a path of least resistance for electric current. This appliance is equipped with a cord having an equipment- grounding conductor and a grounding plug. The plug must be plugged into an appropriate outlet that is properly installed and grounded in accordance with all local codes and ordinances.

▶ **WARNING** - Improper connection of the equipment-grounding conductor may result in a risk of electric shock. Check with a qualified electrician if you are in doubt as to whether the appliance is properly grounded.

▶ Do not modify the plug provided with the appliance - if it will not fit into the outlet, have a proper outlet installed by a qualified electrician.

▶ Before connecting the machine, ensure that the connection data on the data plate (fusing, voltage and frequency) match the main electrical supply. If in doubt contact an electrician.

▶ Do not use an extension cord to connect this appliance to the power supply. Extension cords do not guarantee the required safety of the appliance (e.g. danger of overheating).

▶ Do not install your washing machine in rooms where temperatures below freezing may occur. Frozen hoses may burst under pressure. The reliability of the electronic control unit may be impaired at temperatures below freezing.

▶ Do not install or store this appliance where it will be exposed to the weather.

▶ This appliance is not designed for maritime use or for use in mobile installations such as recreational vehicles or aircraft. However, under certain conditions it may be possible for an installation in these applications. Please contact the Miele Technical Service Dept. with specific requirements.

IMPORTANT SAFETY INSTRUCTIONS

- ▶ Do not install or use a washer with visible damage.
- ▶ Do not repair or replace any part of the appliance or attempt any servicing unless specifically recommended in these operating instructions.
- ▶ Ensure power is not supplied to the appliance while maintenance or repair work is being performed. The machine is only completely isolated from the electrical supply when it is turned off at the main switch and the plug is pulled, or by tripping the circuit breaker.
- ▶ Connect the washer, to the water mains. Do not use old hoses. Inspect the intake hoses regularly for damage. They should be replaced as needed to prevent water damage.
- ▶ Faulty components must only be replaced with genuine Miele spare parts.
- ▶ If the power cord is damaged it must only be replaced by a Miele Service technician with a genuine Miele power cord.
- ▶ Under certain conditions, hydrogen gas may be produced in a hot water system that has not been used for 2 weeks or more. **HYDROGEN GAS IS EXPLOSIVE.** If the hot water system has not been used for such a period, turn on all hot water faucets and let the water flow from each for several minutes before using the washing machine. This will release any built-up hydrogen gas. Do not smoke or use an open flame during this time, the gas is flammable.
- ▶ Remove the door before the appliance is removed for service or discarded.

IMPORTANT SAFETY INSTRUCTIONS

Use

▶ Do not allow children to play on or in the appliance. Close supervision is necessary when the appliance is used near children.

▶ Make sure that no unattended children can access the machine. There is a potential danger that children can be trapped in the drum. This may cause major injuries or the death of the child.

▶ The drum door glass will be hot when washing at very high temperatures.

Do not touch the glass. Danger of burns! Keep children away from the washer when in use.

▶ Only use the washing machine to wash items which are specified by the manufacturer to be machine washable on the fabric care label. Any other applications may be dangerous. The manufacturer cannot be held responsible for damage caused by improper use of the appliance.

▶ Do not wash articles that have been previously cleaned, washed, soaked or spotted with gasoline, dry-cleaning solvents or other flammable substances. These articles give off vapors that could ignite or explode. Do not add these items to the wash load.

▶ Do not add gasoline, dry-cleaning solvents, or other flammable or explosive substances to the wash water. These substances give off vapors which could ignite or explode.

▶ Do not use cleaning solvents on or near the machine or the controls. Contact with cleaning solvents will damage the surface.

▶ Do not reach into the appliance if the drum is moving.

▶ Do not tamper with the controls.

SAVE THESE INSTRUCTIONS

Guide to the washer

Control panel

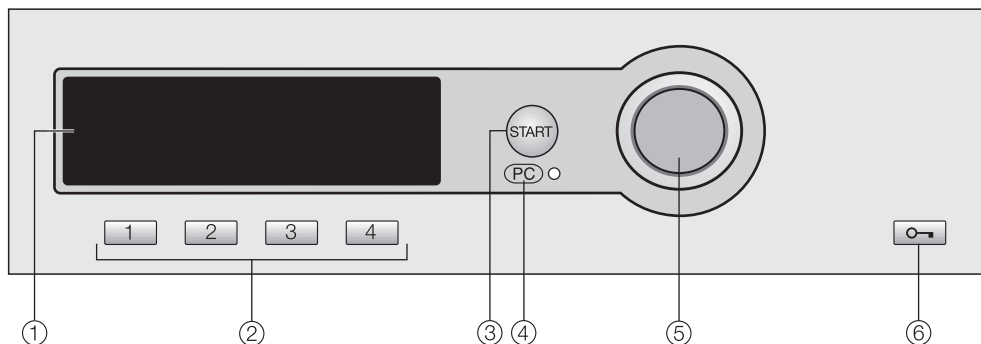

① **Display***

See the following pages for more information

② **Direct select buttons**

To select a wash program directly. You can also save a "Favorite" wash program on these buttons.

③ **"Start" button**

④ **PC Indicator/Optical interface**

Allows a service technician to check and update the wash programs

⑤ **Jog shuttle**

Turn to select menus
Press to confirm the selection

⑥ **Door button**

To open the drum door

* Contents in the display will vary with program offering.

Display function

Display contents will vary with program offering.

Main menu

1	Cottons Uni.	140°F	Program selection...
2	Wrinkle-free	104°F	Settings ↗...
3	Delicates	104°F	
4	Woollens 	86°F	12:00

The display shows the main menu (with default settings). "Program selection" is highlighted.

If the display is dark (in Standby mode) turn the jog shuttle.

Jog shuttle

Turn the jog shuttle to select a program or setting.

Press the jog shuttle to confirm the selection.





Direct select buttons

The first four programs shown in the display on the left are the "Favorites". They can be selected with the direct select buttons.

The Favorites can be individually set to your desire. See "Favorites" for more information.

The direct select buttons have different functions in the other menus. In these menus an arrow ▼ is displayed above the respective button with the function description of the button.

Program selection possibility

- **Possibility 1** Select and confirm the menu "Program selection" in the display with the jog shuttle.
- **Possibility 2** Press one of the direct select buttons     for direct access of the basic menu for the selected program.

Guide to the washer

Menu Program selection



All pre-set programs can be selected with the jog shuttle. Depending on the direction the jog shuttle is turned the highlighter moves up or down.

The arrows ▼▲ at the right side of the display show that more selections are available.

- Press the jog shuttle to open the basic menu of the selected program.

Basic menu of a wash program

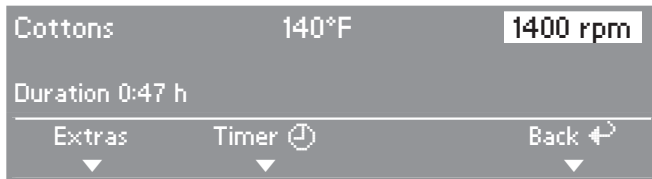

The program components (program, temperature and spin speed) can be selected by turning the jog shuttle. The selected component is highlighted. Press the jog shuttle to select the component. The respective submenu is displayed.

The submenus "Extras" and "Timer" can be selected with the direct select buttons.

- To go back to the main menu press 4 "Back".

All components can also be selected and confirmed using only the jog shuttle.

Settings

The "Settings" menu allows you to adjust the washer to individual needs. See "Settings" for more information.

Before using for the first time

The appliance must be correctly installed and connected before the first use. Please see the "Installation instructions."

For safety reasons, it is not possible to run a spin cycle before the first use. A program must be run **without laundry and detergent** to flush out any residual water from the factory testing process.

- Open the water supply.

Welcome screen

The Welcome screen shows when the washer is turned on for the first time: "Miele Professional Welcome".

The Welcome screen will not show after the washer has been running for more than 1 hour.

The display then shows the language selection.

Language

- Select the desired language and confirm with "OK".

Shipping struts

The display reminds the user to remove the shipping struts.

- If the shipping struts were already removed, confirm with the  button. Otherwise, remove them at this time then confirm.

Set the time of day

- Set the hour by turning the jog shuttle, press to confirm.
- Repeat to set the minutes and confirm. Press again to save the time of day.

First wash

- Select the program "Cottons Uni." and confirm.

The basic program "Cottons Uni." shows.

- Press the flashing button "Start".
The drum door must be closed.

Once the program ends the washer can be used for laundry.

Use

1. Sort the laundry

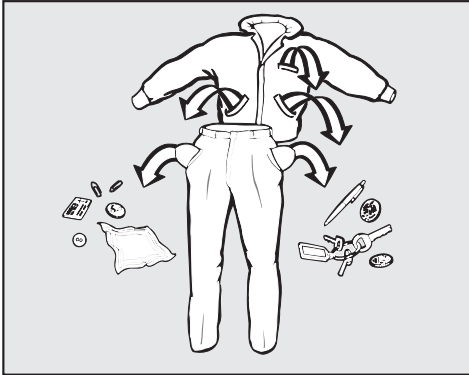

- Empty all pockets.

 Foreign objects left in pockets (e.g. nails, coins, paper clips, etc.) can cause damage to clothes and the machine.

- Pre-treat stains.

Tough stains (blood, egg, coffee, tea etc.) or badly soiled areas (collars and cuffs) should be pre-treated with a stain remover or a paste made of powder detergent and warm water. Dab stains with a damp light colored cloth. Do not rub.

 Do not use chemical solvents in the machine.

- Sort the laundry.

General tips

- Dark fabrics often bleed the first few times they are washed. They should be washed separately several times before being included in a mixed load.
- Remove any lead weights or strips from curtains before washing.
- Loose under-wires should be removed or sewn in place before washing.
- Woolens and knitted garments should be turned inside out.
- Close zippers and hooks and eyes before washing.
- Comforter covers and pillowcases should be fastened in order to prevent small items from getting trapped inside of them.

Do **not** machine wash items if it is not recommended on the fabric care label.

2. Load the washer

- Open the drum door using the  button.

The drum light comes on.

- Load the laundry loosely into the drum.

For best results, wash mixed loads of small and large items. This will improve washing effectiveness and help distribute the load evenly.

For the lowest energy and water consumption load the washer to its max. capacity. See "Program guide".

Note: Overloading the washer will affect wash results and cause wrinkling.

- Close the drum door.

To prevent damage to the door seal and clothing, make sure that there are no clothes caught between the drum door and the seal.

3. Select a program

Two program selection possibilities:

- Select a "Favorite" by pressing the respective direct select button.
- Select from the "Program selection" menu by turning the jog shuttle.

- If desired select "Extras" and/or a "Timer" start time with the respective submenus.

See "Program Guide", "Spin Speed", "Extras" and "Timer" for more info.

Coin mechanism

If a coin mechanism operates the machine, please regard the displayed request to pay.

If the door is opened after a program has started or if the program is canceled the credit is lost.

Use

4. Adding detergent

Use detergent according to the laundry soiling and water hardness.

Too little detergent may cause:

- ineffective cleaning of laundry; fabrics may become gray and stiff over time.
- grease stains on the laundry.
- hard water deposits on the heating element.

Too much detergent may cause:

- over sudsing with minimal drum movement; poor wash, rinse and spin results.
- higher environmental burden.

See "Detergent" for more information.

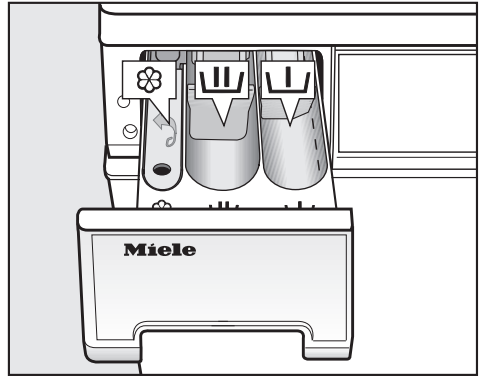

- Pull out the detergent dispenser drawer and add detergent.

 = Detergent for the main wash

 = Only add detergent ($\frac{1}{4}$ of the total recommended amount of detergent) to this compartment for the pre-wash.



 = Fabric softener or liquid starch.

- Close the detergent dispenser drawer.

Using powder detergent

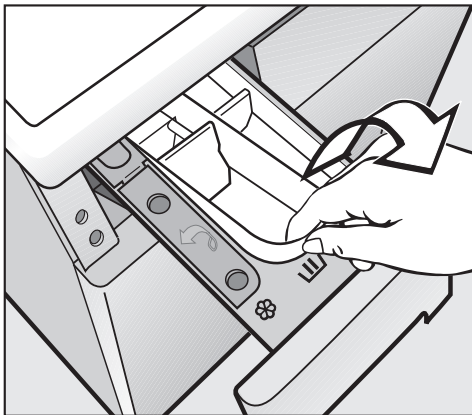
Liquid detergent inserts come already inserted in the detergent compartments. To use powder detergent remove the inserts.



- Remove the inserts from both compartments  and .

Detergent for "Heavy Soil"

- Only add detergent ($\frac{1}{3}$ of the total amount recommended) to the  compartment, if the "Heavy Soil" option is selected.

Since powder detergents already contain bleach, using additional liquid bleach is not recommended.

Detergent for the main wash

Fabric softener or liquid starch

Replace the inserts in the compartments before using liquid detergent.

Use

5. Starting a program

"Start" flashes when a program can be started.

- Press the "Start" button.

The "Start" button lights.

The display shows the approximate program run time. It will count down in minutes. In the first 10 minutes the washer calculates the water absorbency of the laundry. The overall program time may be shortened or lengthened.

Additionally the sequence cycle is displayed. The washer shows the current program step.

The drum light turns off after the program starts.

Press one of the following direct select buttons during the running program:

- Button **1** "Extras"
the displayed Extras can be selected or deselected after the program start.
- Button **2** "Timer"
the time of day and the approximate program end is displayed.
- Button **4** "Cancel"
to cancel the currently running program. The wash water will be drained away.

6. At the end of a program

The anti-crease program starts when the laundry is not immediately removed from the washer after the program end. "Anti-crease" and "End" will flash alternately in the display.

- Use the  "Door" button to open the drum door.
- Remove the laundry.

Check the drum for any missed pieces of laundry. Items inadvertently left in the washer may get damaged (e.g. shrink or discolor) during the next wash cycle.

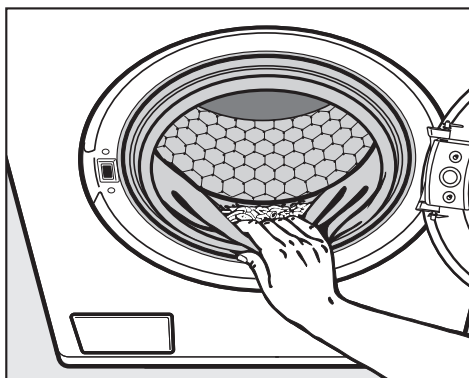

- Check the folds of the door seal for any small articles which may have been trapped.
- Close the drum door. Otherwise foreign objects may find their way into the drum. These could be inadvertently washed and cause damage to laundry.

To cancel a program

A program can be canceled any time after the program start.

- Press the  button "Cancel".

The wash water will be drained away.

- Open the drum door before starting a new program.

To change a program

After the program start the spin speed can be selected until the final spin starts. The Extras "Starch Stop" and "Rinse Stop" can be selected or deselected.

The temperature and the Extra "Intensive" can be selected or deselected up to 5 minutes after the program start.

Adding/removing laundry during a wash program

You can interrupt the programs (see "Program guide") to add or remove a piece of laundry.

- Use the  button to open the door.
- Add or remove the piece of laundry.
- Close the drum door.

The program will continue automatically.

Note:

Once the program has started the washer cannot make adjustments to the load size. After adding or removing laundry, the washer will default to the water and electrical consumption of a full load.

The time remaining will automatically be adjusted.

The drum door cannot be opened if:

- the water temperature is higher than 131°F/55°C.
- the water level is too high.
- the program has reached the "Final Spin".

When operated with a coin mechanism the machine will be locked after 3 minutes. Canceling or changing a program and opening the door is no longer possible.

Program guide

Programs may vary.

Cottons Hygiene 203°F to 158°F (95°C to 70°C)		max. 14.3 lbs (6.5 kg)
Items	Items made from cotton and linen, i.e. bed linens, baby clothing, underwear	
Detergent	Universal detergent	
Extras	Pre-wash, Starch Stop, Rinse Stop, Intensive*, Water plus*	
Note	The spin speed (1400 rpm) cannot be changed.	
Cottons Uni. 140°F (60°C) to cold		max. 14.3 lbs (6.5 kg)
Items	Items made from cotton or mixed fabrics, i.e. T-Shirts, pants	
Tip	Wash dark colored fabrics with detergent for colors or a liquid detergent.	
Detergent	Universal or color detergent	
Extras	Pre-wash, Starch Stop, Rinse Stop, Intensive*, Water plus*	
Note	The spin speed (1400 rpm) cannot be changed.	
Minimum iron 140°F to 86°F (60°C to 30°C)		max. 6.6 lbs (3.0 kg)
Items	Items made from synthetic fibers, mixed fabrics or wrinkle free cottons, i.e. shirts	
Detergent	Universal or color detergent	
Extras	Pre-wash, Starch Stop, Rinse Stop, Intensive*, Water plus*	
Delicates 140°F to 86°F (60°C to 30°C)		max. 5.5 lbs (2.5 kg)
Items	Delicates made from synthetic, mixed fabrics or viscose silk	
Detergent	Detergent for delicates	
Extras	Pre-wash, Rinse Stop, Intensive*	

* "Intensive" and "Water plus" can be added in "Settings - Supervisor level" when activated by Technical Service.

Program guide

Quick wash 104°F (40°C) to cold		max. 7.7 lbs (3.5 kg)
Items	Small loads of lightly soiled items, which can be washed in "Cottons Uni."	
Detergent	Universal or color detergent	
Extras	Rinse Stop	
Woollens 104°F (40°C) to cold		max. 5.5 lbs (2.5 kg)
Items	Items made from machine washable wool and wool blend fabrics.	
Detergent	Detergent for wool	
Extras	Rinse Stop	
Silks  86°F (30°C) to cold		max. 5.5 lbs (2.5 kg)
Items	Hand washable items, that contain no wool	
Tip	Wash hosiery and lingerie in a lingerie bag	
Detergent	Detergent for delicates	
Extras	Rinse Stop, Water plus*	
Shirts 140°F (60°C) to cold		max. 5.5 lbs (2.5 kg)
Items	Shirts and dress shirts.	
Tip	<ul style="list-style-type: none"> – Pre-treat collars and cuffs if needed. – Wash silk shirts in the "Silk" program. 	
Detergent	Universal or color detergent	
Extras	Rinse Stop	

* "Intensive" and "Water plus" can be added in "Settings - Supervisor level" when activated by Technical Service.

Program guide

Denim 104°F (40°C) to cold		max. 7.7 lbs (3.5 kg)
Tip	<ul style="list-style-type: none"> – Before washing denim items turn them inside out. – Denim items bleed during the first few washes. Wash dark and light colored items separately. 	
Detergent	Liquid color detergent	
Extras	Rinse Stop	
Toweling 203°F to 140°F (95°C to 60°C)		max. 12.1 lbs (5.5 kg)
Tip	Wash dark colors with a color detergent	
Detergent	Universal detergent	
Extras	Rinse Stop	
Starch		max. 14.3 lbs (6.5 kg)
Tip	The laundry (table linen, napkins, etc.) should be washed as usual but not treated with fabric softener.	
Starch	Liquid or powder starch	
Extras	Rinse Stop	
Extra rinse		max. 14.3 lbs (6.5 kg)
Items	For items which need only rinsing and spinning	
Extras	Rinse Stop	
Drain		
To drain the water from the drum		
Spin		max. 14.3 lbs (6.5 kg)
Select an appropriate spin speed		

* "Intensive" and "Water plus" can be added in "Settings - Supervisor level" when activated by Technical Service.

Additional programs

The following programs can be added in "Settings - Supervisor level" when activated by Technical Service.

Kitchen linen 203°F to 140°F (95°C to 60°C)		max. 14.3 lbs (6.5 kg)
Items	Kitchen linens made from cottons and linen fabrics, i.e. chef jackets and pants, towels, rags	
Tip	Use the "Pre-wash" program for tough stains. Use a pre-wash detergent with enzymes.	
Detergent	Universal detergent	
Extras	Pre-wash, Rinse Stop	
Table linen 140°F to 86°F (60°C to 30°C)		max. 5.5 lbs (2.5 kg)
Items	Tablecloths and napkins made of cotton, linen or mixed fabrics.	
Tip	Use the "Pre-wash" program for tough stains. Use a pre-wash detergent with enzymes.	
Detergent	Universal detergent	
Extras	Pre-wash, Starch Stop, Rinse Stop, Intensive*, Water plus*	
Curtains 104°F (40°C) to cold		max. 6.6 lbs (3.0 kg)
Items	Curtains which are machine washable according to the manufacturer. To rinse dust, a pre-wash without detergent is automatically added to the program.	
Tip	Curtains that wrinkle easily should be washed at a reduced spin speed or without a spin.	
Detergent	Curtain, universal and color detergent in powder form.	
Extras	Pre-wash, Rinse Stop	

* "Intensive" and "Water plus" can be added in "Settings - Supervisor level" when activated by Technical Service.

Program guide

Pillows 203°F to 104°F (95°C to 40°C)		1 queen (80x80 cm) or 2 twin size pillows (40x80 cm)
Items	Washable pillows with a filling of feathers, down or synthetics.	
Tip	Regard the fabric care label!	
Detergent	Liquid detergent	
Extras	Rinse Stop	
Outerwear 104°F (40°C) to cold		max. 6.6 lbs (3.0 kg)
Items	Outdoor clothing made from micro fibers.	
Tip	<ul style="list-style-type: none"> - Close all zippers. - Do not use fabric softener 	
Detergent	Detergent for delicates	
Extras	Rinse Stop	
Proofing 104°F to 86°F (40°C to 30°C)		max. 6.6 lbs (3.0 kg)
Items	To treat micro fiber, ski clothing, fine dense cotton (poplin) or tablecloths to make them water repellent and soil resistant.	
Tip	<ul style="list-style-type: none"> - The item should be washed and rinsed or dried. - To get an optimum result dry the items in a clothes dryer or iron them. 	
Water repellent	<ul style="list-style-type: none"> - Only use water repellent that states it is "Suitable for membrane textiles". They are based on fluorochemicals. Do not use agents containing paraffin. - Place the liquid detergent insert into compartment  an fill with water repellent. 	
Extras	Rinse Stop	

Program guide

Disinfection programs		max. 14.3 lbs (6.5 kg)
Items	Items made of cotton or mixed fabrics.	
Note	For different requirements with a temperature selection of 185°F [85°C (thermal)] to 104°F [40°C (chemothermal)] with the respective holding times.	
Detergent	Use a detergent for disinfection and chemothermal disinfection. Regard the temperature level recommended on the packaging.	
Extras	Pre-wash	
Hygiene		
If a temperature lower than 131°F (55°C) was selected for the last wash program or if the program "Spin" was selected, "Hygiene" is displayed.		
When selecting a Hygiene program:		
<ul style="list-style-type: none"> – do not put any laundry into the drum, add a small amount of detergent in compartment  and start the program, 		
or		
<ul style="list-style-type: none"> – select a wash program with a temperature of 140°F (60°C) or higher. 		
If the "Hygiene" display is disregarded, each program will run accordingly.		
Sluice 167°F (75°C) or Sluice 146°F (65°C)		max. 14.3 lbs (4.0 kg)
Items	Heavily soiled items of cotton, linen or mixed fabrics.	
Note	To remove heavy soiling the laundry will be pre-rinsed twice.	
Detergent	Universal detergent	

Program sequence

*Programs may vary depending on the offerings of your machine.

	Main wash		Rinse		Spin	
	Water level	Wash rhythm	Water level	Rinses	Rinse spin	Final spin
Cottons Hygiene		Ⓐ		2	✓	✓
Cottons Uni.		Ⓐ		2	✓	✓
Minimum iron		Ⓐ		2	✓	✓
Delicates		Ⓑ		2	–	✓
Quick wash		Ⓐ		2	✓	✓
Woolens		Ⓒ		2	✓	✓
Silks		Ⓓ		2	–	✓
Shirts		Ⓐ		2	–	✓
Disinfection*		Ⓐ		3	✓	✓
Kitchen linen*		Ⓐ		2	✓	✓
Table linen*		Ⓐ		2	✓	✓
Curtains ¹⁾ *		Ⓐ		3	–	✓
Pillows ²⁾ *		Ⓐ		3	–	✓
Outerwear*		Ⓑ		3	✓ ³⁾	✓
Proofing*	–	–		1	✓	✓
Denim		Ⓐ		3	–	✓
Toweling		Ⓐ		2	–	✓
Extra Rinse	–	–		2	✓	✓
Sluice ⁴⁾ *		Ⓐ		3	✓	✓
Starch	–	–		1	–	✓
Spin	–	–	–	–	–	✓

 = low water level

 = middle water level

 = high water level

Ⓐ = normal wash rhythm

Ⓑ = Gentle wash cycle

Ⓒ = Woolens

Ⓓ = Silk

For program sequence explanations, see the following page.

* Programs may be added in "Settings - Supervisor level" when activated by Tech. Service.

The washer is equipped with an electronic control which determines the load size automatically. The washer determines the required water consumption for each load depending on quantity and water absorbency of the laundry. Different program sequences and wash times will result.

The program sequence shown here represents the basic program with a maximum load. Possible "Extras" are not considered.

The washer's sequence display will indicate the current cycle of the selected wash programs.

Special features in the program sequence:

Anti-crease

The drum continues to turn up to 30 minutes after the program ends to prevent creases. The washer can be opened at any time.

Exception: The program "Woollens" has no anti-crease feature.

1) **Pre-rinse**

To rinse dust, a pre-wash without detergent is automatically added to the program.

2) **High Spin**

Before the wash program starts, a high spin is carried out to remove air from the pillows. After the spin the program starts with the water intake.

3) **Outerwear**

The items will be spun only after the main wash.

4) **Pre-rinse**

To remove heavy soiling the laundry will be pre-rinsed twice.

Spin speed

Maximum spin speeds

Program	rpm
Cottons Hygiene	1400
Cottons Uni.	1400
Minimum iron	1000
Delicates	600
Quick wash	1400
Woollens	1200
Silks	400
Shirts	600
Disinfection programs*	1400
Kitchen linen*	1400
Table linen*	1200
Curtains*	400
Pillows*	1400
Outerwear*	900
Proofing*	800
Denim	900
Toweling	1400
Extra Rinse	1200
Sluice*	1400
Starch	1400
Spin	1400

* Programs can be added in "Settings - Supervisor level" when activated by Technical Service.

You can reduce the final spin speed. Exception: The spin speed cannot be changed in the *Cottons Hygiene* and *Cottons Universal* programs. The speeds above are the highest available.

Rinse spin

The laundry is spun after the main wash and between the rinse cycles. Reducing the final spin speed will also reduce the rinse spin speeds.



Without final spin

■ Select "Rinse Stop" from the submenu "Extras". The laundry is not spun and remains soaking in water. This will prevent wrinkles if the laundry is not removed immediately at the end of the wash program.

– Selecting the final spin

The washer is set by default to the maximum spin speed of the wash program. You can select a lower spin speed. Press "Start" to start the final spin.

– To finish the program

Press the  button. The water will be drained. Press the  door button to open the door.

Deselect rinse spin and final spin

■ Select "Without spin". The laundry is not spun after the final rinse but the water is drained away. After the drain cycle the washer goes immediately into the anti-crease cycle.

The basic wash programs can be enhanced with "Extras".

Accessing the submenu "Extras"

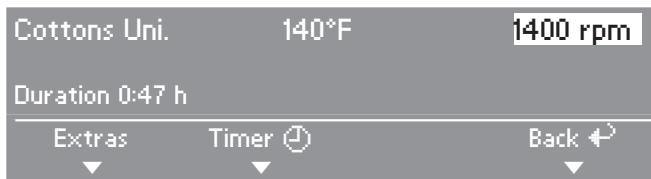

- Press the direct select button **[1]**. The submenu "Extras" shows.

Selecting Extras

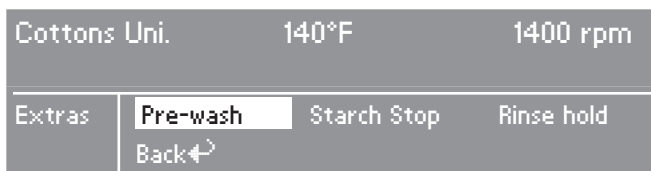

- Select the desired Extras with the jog shuttle and confirm.
 - Repeat if another Extra is desired.
 - A selected Extra is marked with a check mark.

Pre-wash

For laundry with heavy soiling e.g. dust, sand.

Starch Stop

The water is drained away before the last rinse and the program stops.

Add the starch directly to the laundry in the drum and continue the program. See "Detergent - Separate starch" for more information.

Extras

Rinse Stop

The washer stops after the last rinse, the laundry remains soaking in water. This will prevent wrinkles if the laundry is not removed immediately at the end of the wash program.

Intensive*

For laundry with normal to heavy soiling or stains.

The total time for the wash program will be extended.

Water plus*

The washer comes factory set with the Extra selection "Water plus" activated. The water level during washing and rinsing is increased.

Other settings for "Water plus" can be selected. See "Settings" for more information.

* "Intensive" and "Water plus" can be added in "Settings - Supervisor level" menu when activated by Technical Service.

Extras which can be selected are shown in the submenu "Extras". If an Extra is not shown, it is not available for the selected program.

The timer option allows you to select the program end time. The program start can be delayed from 30 minutes to 24 hours.

Select the submenu Timer

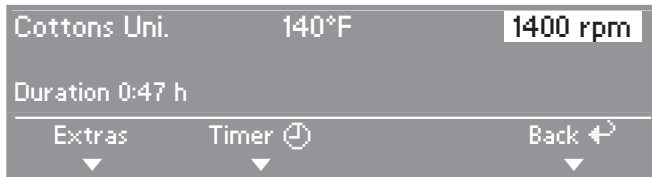

- Press the direct select button **[2]**. The "Timer" menu shows.

Select the Timer time

The program end can be selected in 30 minute increments.



- Select the desired program end time with the jog shuttle and confirm. The program end time is adjusted to the next full or half hour. The program start will be delayed according to the desired program end time.

Starting the Timer

- Press the "Start" button.

The elapsed timer time is displayed and will count down in minutes.

Canceling the Timer

- The Timer can be canceled with the direct select button **[4]**.

After the program start the actual load size is measured. This can result in an earlier program end.

Favorites

The washer has the option to save the most used wash programs on the direct select buttons. The option "Save" must be selected in "Settings - Supervisor level". Contact Technical Service for access to this level.



Selecting/Changing a Favorite

Main menu

1	Cottons Uni.	140°F	Program selection...
2	Minimum iron	104°F	Settings ↗...
3	Delicates	104°F	
4	Woollens 	85°F	12:00

- Press the direct select button .

Basic menu

Cottons Uni.	140°F	1400 rpm	
Duration 0:47 h			
Extras ▼	Timer  ▼	Save ▼	Back  ▼

- Turn the jog shuttle to select the component you want to adjust: program, temperature spin speed.
- Press the jog shuttle to confirm the selection.

Depending on the selection the display shows one of the following submenus.

Important: If no selection is made in the submenu, the display will switch back to the basic menu after 20 seconds.

– Select a program



- Select the desired program with the jog shuttle and confirm. The basic menu shows again.

– Selecting a temperature

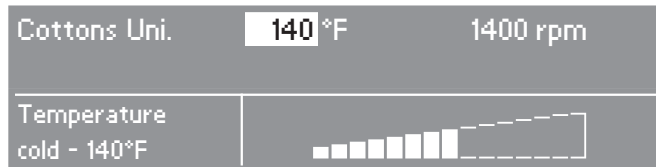

- Select the desired temperature with the jog shuttle and confirm. The basic menu shows again.

– Selecting the spin speed

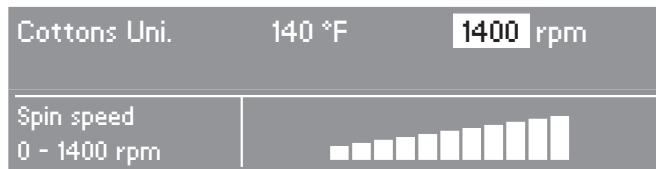

- Select the desired spin speed with the jog shuttle and confirm. The basic menu shows again.

Selecting Extras

- Press the direct select button . The submenu "Extras" shows.

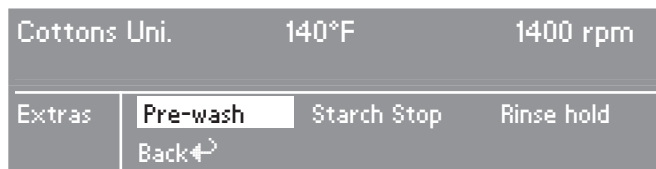

- Select the desired Extras with the jog shuttle and confirm. The basic menu shows again. Repeat if another Extra is desired. See "Extras" for more information.

Favorites

Saving a Favorite

The basic menu shows all selected components.

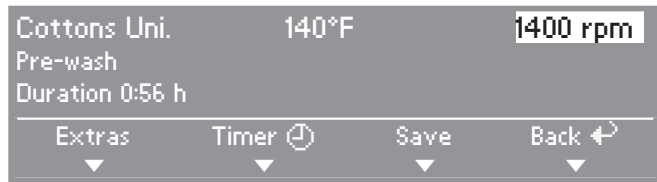

- Press the direct select button [3].

Assigning a direct select button

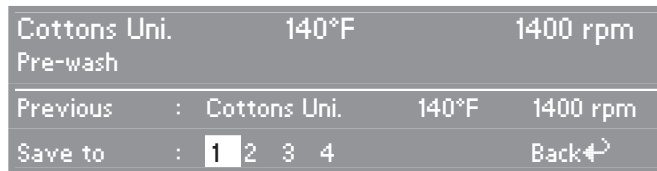

- Select the desired number for the favorite with the jog shuttle and confirm. The favorite is saved with the individual selections and shows in the main menu.

To assign more favorites, repeat the process with the remaining direct select buttons.

Only use laundry detergent formulated for front loading washing machines.

For wool and wool blend fabrics use a detergent formulated for wools.

Follow instructions on the detergent packaging for the correct use and amount of detergent.

The amount of detergent used depends on the level of soiling:

Light soiling

No soiling or stains are visible

Normal soiling

Some visible soiling or a few light stains

Heavy soiling

Very visible soiling or stains

The size of the load and the water hardness level in your area have an impact on the amount of detergent necessary to obtain optimum wash results. If you do not know the water hardness level in your area, contact your local water authority.

Water hardness

Hardness level	Water quality	Water hardness in gpg (also German hardness in °d)	Water hardness in mmol/l
I	soft	0 - 7	0 - 1.3
II	moderate	7 - 14	1.3 - 2.5
III	hard to very hard	over 14	over 2.5

Water softener

If the water hardness level is between II and III, you can soften the water to reduce detergent consumption.

The detergent packaging should indicate the correct amount to use in your machine. Add the detergent, then add the water softener. From then on you can then use the recommended amount of detergent for water hardness level I.

Detergent

Fabric softener, liquid starch

Fabric softener added to the wash program will make fabrics feel softer and will reduce static cling in the dryer.

Liquid starch is a synthetic starch wash used to give fabrics some stiffness. Starch can be included in any wash program as part of the final rinse.

Automatic dispensing of fabric softener or liquid starch

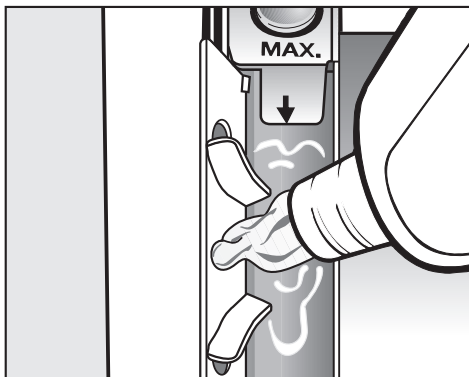

- Add the fabric softener or liquid starch to compartment ☼. **Do not exceed the Max. level mark.**

The softener or liquid starch is automatically dispensed in the final rinse. At the end of the program a small amount of water remains in the fabric softener compartment ☼.

If you use starch frequently, clean the dispenser compartment and especially the siphon tube and conditioner channel. See "Cleaning the detergent drawer".

Separate fabric softener

- Add fabric softener to the  compartment.
- Select the "Starch" program.
- Press "Start".

Separate starch

- Prepare and dispense the amount of starch recommended on the packaging.
- Add starch to the  compartment.
- Select the program "Starch".
- Press "Start".

Starching with Starch Stop

- Prepare and dispense the amount of starch recommended on the packaging.
- Select "Extra Starch" before starting the program.

The program and the remaining time will stop. The display shows "Starch".

- Open the door and dispense the starch directly into the drum.
- Close the drum.
- Select a spin speed and confirm or press "Start".

Dye removers / Fabric dyes

Do not use dye removers in this washer.

- When dyeing fabrics in the washer, adhere to the manufacturer's instructions.

External dispensing

As an option the washer can be connected to an external detergent dosage system. A conversion kit is necessary which can be purchased from Miele.

Cleaning and Care

 Before cleaning the appliance, disconnect the power supply by unplugging the unit or manually tripping the circuit breaker. Never clean the machine or near its vicinity with a water or high pressure hose.

 Do not use chemical solvents, abrasive cleaners, glass or all purpose cleaners. These can damage plastic surfaces and other parts.

Cleaning the washer

- Clean the exterior of the washer with a mild solution of non-abrasive detergent or soap and water. Wipe dry with a soft cloth.
- Clean the drum with a stainless steel cleaner specially formulated for use in a washing machine.

Cleaning the detergent drawer

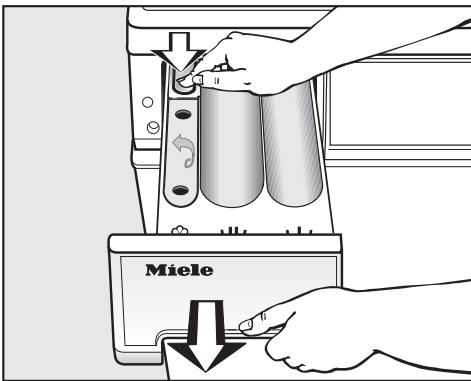

Detergent residue should be cleaned out regularly.

- Pull out the detergent drawer as far as it will go. Press the red release lever down and pull the drawer out of the machine.
- Clean the detergent drawer with warm water.

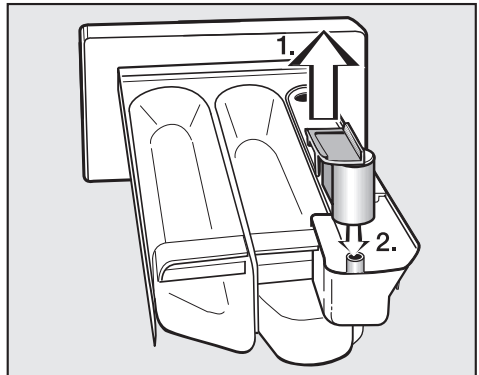

- Clean the siphon tube.
 1. Remove the siphon tube from the compartment  and rinse under warm water. Clean the pipe on which the siphon tube is attached.
 2. Replace the siphon tube.

Clean the siphon tube and fabric softener channel more often when frequently using liquid starch. Liquid starch tends to stick.

Cleaning the niche of the detergent drawer

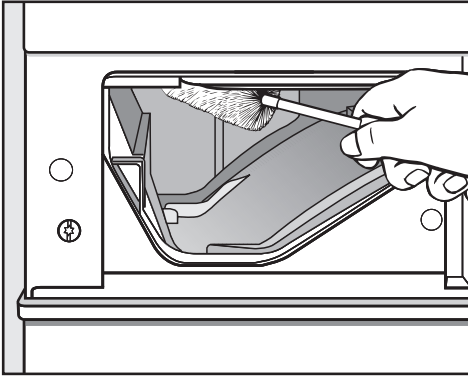

- Using a bottle brush remove any detergent or lime deposits from the water inlet valves at the top of the detergent drawer niche.

Cleaning the liquid detergent inserts

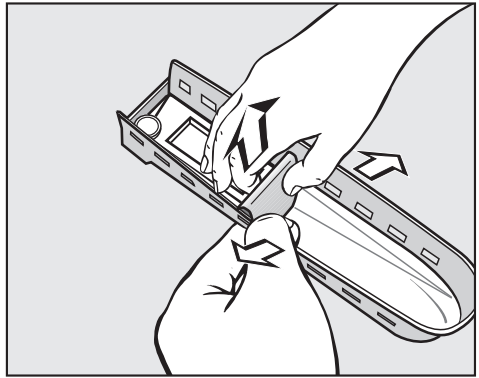

- Push the insert apart and remove the siphon for easy cleaning.

Cleaning and Care

Cleaning the inlet hose filter

The washer has two water inlet filters to protect each inlet valve. Check and clean these filters every 6 months. This may have to be done more frequently with some water supplies.

Cleaning the inlet hose filters

- Turn off the water supply.
- Unscrew the inlet hose from the valve by turning the connector counterclockwise, use a wrench if necessary.

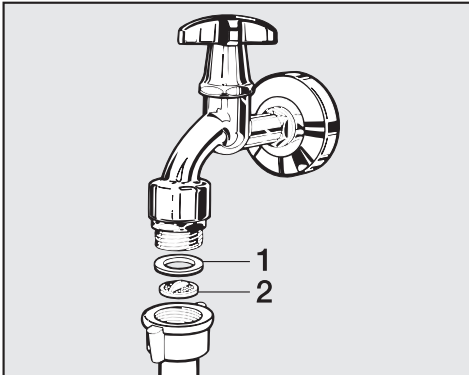

- Remove the rubber seal, **1**, from the connector.
- Using needle nose pliers, grasp the plastic filter, **2**, and pull it out of the hose connector.
- Clean the filter under running water and carefully remove any large particles.
- Replace the filter and seal and reconnect the hose.
- Slowly turn on the water supply and check for leaks. If water leaks, tighten the hose connection.

Cleaning the filter in the inlet valve

- Using pliers carefully loosen and remove the plastic hose connector from the inlet valve.

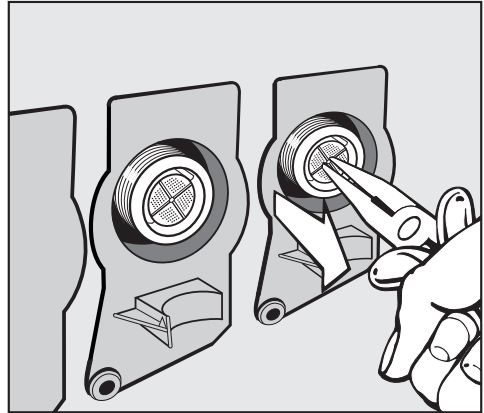

Using needle nose pliers, remove the plastic filter by pulling on the bar (see illustration). Rinse under running water and return. Replace the filter and seal, then reconnect the hose.

Both filters **must** be put back in place after cleaning.

Frequently asked questions

 Repairs to electrical appliances must only be carried out by a qualified and trained person in accordance with local and national safety regulations. Repairs and other work by unqualified persons could be dangerous.

The following section will help you avoid placing a service call by identifying issues you may encounter while operating the machine:

A wash program cannot be started		
Problem	Possible cause	Solution
The display remains off.	The washer has no power.	Possible fault: <ul style="list-style-type: none">– the washer is not connected to the electrical supply.– the circuit breaker has tripped.
When selecting the "Spin" program, the program does not start.	The instructions in "Before using for the first time" were not followed.	Follow the instructions as described in "Before using for the first time".
There is a fault message in the display.	As long as an error message is displayed, a program cannot be started.	<ul style="list-style-type: none">– Regard the display messages.– Confirm by pressing the jog shuttle.
The display is dark and the "Start" light flashes slowly.	The machine goes into "Standby" mode. The display shuts off to save energy.	Press any direct select button. The Standby function will end.

Frequently asked questions

General problems with the washer		
Problem	Possible cause	Solution
The washer shakes during the spin cycle.	<ul style="list-style-type: none"> – The four feet are not resting evenly on the floor. – The floor is not properly reinforced. 	<ul style="list-style-type: none"> – Level the machine (see Installation Instructions). – It is recommended that the machine be installed on a concrete base.
There are unusual sounds coming from the drain pump.	There is not a fault. Lapping sounds at the beginning and end of the pump process are normal.	
Large residues of detergent remain in the dispenser drawer.	The water pressure is too low.	<ul style="list-style-type: none"> – Check and clean the filters in the water inlet hoses. – Select the "Water plus" Extra if desired.
	Water softening detergent additives tend to stick.	Clean the detergent drawer. In the future add the detergent first and then the water softener to the compartment.
The fabric softener is not completely dispensed or too much water remains in the compartment ☼.	The siphon tube is either incorrectly positioned or clogged.	Clean the siphon tube, see "Cleaning and care-Cleaning the detergent dispenser drawer".
The display shows a foreign language.	A different language was selected under "Settings-Language 🇫🇷".	Select the desired language. The flag symbol leads you to the setting.

Frequently asked questions

Poor wash results		
Problem	Possible cause	Solution
The laundry does not get clean with liquid detergent.	Liquid detergents do not contain bleaching agents. Fruit, coffee and tea stains may not be removed.	<ul style="list-style-type: none"> – Use powder detergent containing bleach. (Be sure this is suitable according the fabric care labels of the laundry.) – Fill powder bleach in compartment  and use a dispenser ball for the liquid detergent. – Never put liquid detergent and bleach together in the same wash compartment.
Laundry has a gray sticky residue.	<ul style="list-style-type: none"> – Not enough detergent was used to dissolve greasy deposits in heavily soiled laundry. – The laundry was soiled with grease (oils, lotions). 	<ul style="list-style-type: none"> – Add more detergent to laundry with grease stains or use a liquid detergent. – Run a 140°F (60°C) program with liquid detergent to clean the washer before using it for laundry again.
There is white detergent residue on dark laundry.	The powder detergent was not completely dissolved because of hard water. These residues are difficult to remove.	<ul style="list-style-type: none"> – After drying, remove white residues with a clothes brush. – In the future, use liquid detergent.
Items with greasy soiling are not clean after a wash program.	<ul style="list-style-type: none"> – Add a Pre-wash to the program. Use liquid detergent for the pre-wash. – Use a powder detergent for the main wash. <p>Use detergent which is specially formulated for heavily soiled work clothes. Contact the detergent manufacturer for more information.</p>	

Frequently asked questions

The door will not open when the "🔒" button is pressed

Problem	Solution
The washer has no power.	Insert the plug into the outlet and ensure the circuit breaker has not tripped.
Power failure	To open the drum door, see "Frequently asked questions - Opening the drum door during a power failure...".
The door was not properly closed.	Push the drum door on the locked side. Then press the "Door" button.
There is still water in the drum and the washer cannot drain it away.	Clean the drain filter and the drain pump as described in "Frequently asked questions - Opening the drum door during a power failure...".
As a safeguard against scalding, the drum door cannot be opened if the wash water temperature is over 131°F (55°C).	

Frequently asked questions

Opening the door during a power failure or when the drain is blocked

⚠ Disconnect the machine from the power supply.

- Open the detergent dispenser drawer.

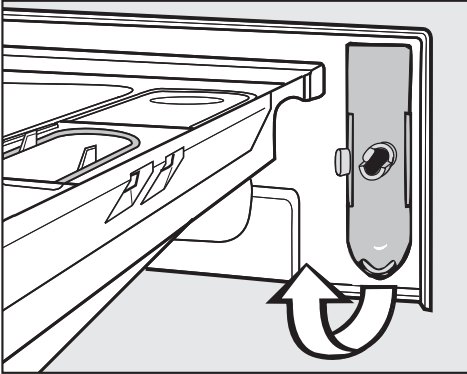

- Remove the tool.

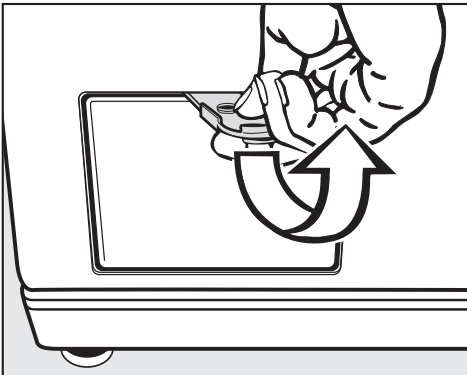

- Open the lint trap door.

Machines with a drain pump

If the main drain hose is clogged, water will be retained in the machine (**max. 6.5 gal [30 l]**).

⚠ Caution: If laundry has been washed at a high temperature, the water draining out of the machine will still be hot! Stop and allow it to cool before proceeding.

- Place a 2 quart container under the drain tube.



- Turn the lint trap lid counterclockwise. **Do not remove it.** About 2 quarts of water will drain out of the hose.

If additional water remains in the machine, tighten the lint trap lid and empty the container. Repeat as necessary.

Frequently asked questions

Once the flow of water stops:

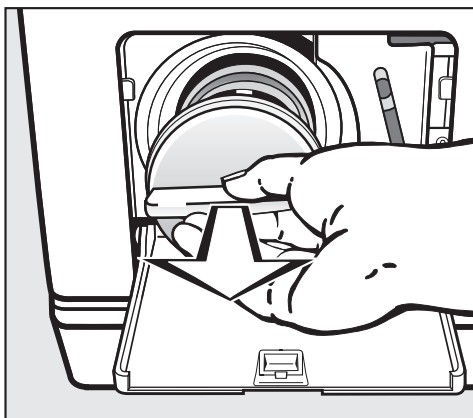

- Remove the lint trap lid.
- Remove any foreign objects or lint from the filter.

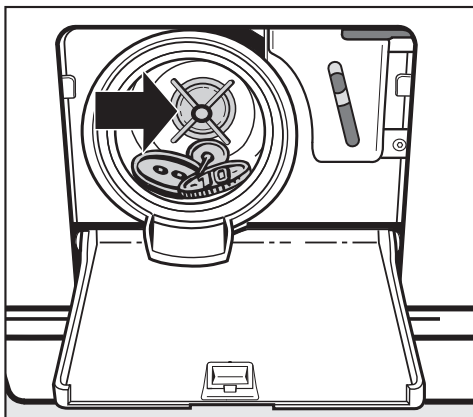

- Check that the impeller (in the back of the chamber) rotates freely by spinning it with your hand.
- Return the lint trap lid and tighten into place.

If the drain filter is not tightened securely water will leak out when the machine is used.

Open the drum door

 Always make sure the drum is stationary before reaching in to remove laundry. A moving drum is extremely dangerous.

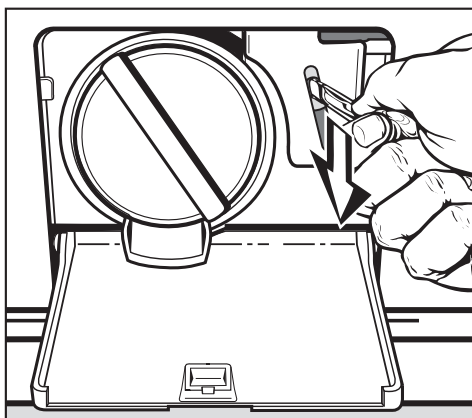

- Insert a screwdriver into the notch, beside the lint trap, pull it down. The door will now open.

Frequently asked questions

Machines with a drain valve

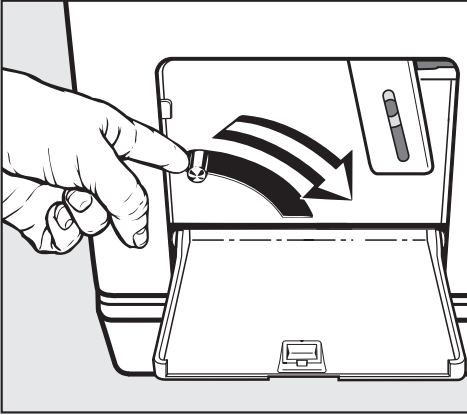

- Press the lever for the emergency drain down and hold until you hear no more water running out.

Open the drum door

 Always make sure the drum is stationary before reaching in to remove laundry. A moving drum is extremely dangerous.

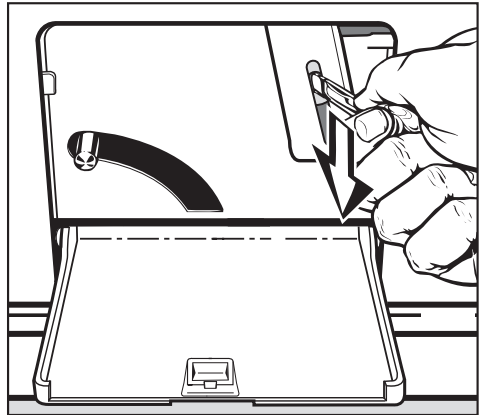

- Insert a screwdriver into the notch beside the lever, pull it down. The door will now open.

After sales service

Repairs

In the event of a fault which you cannot easily fix yourself, please contact technical service using the information on the back of this manual.

- Please quote the model and serial number of your appliance when contacting the Technical Service Department.

Both can be found on the data plate visible above the front glass on the inside of the door.

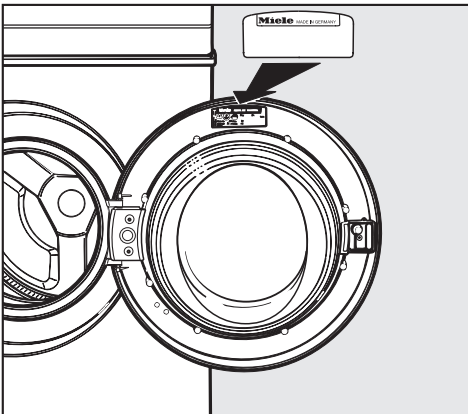

PC Update

The indicator marked PC allows a technician to make use of new technology. When, for example, new programs are developed or new fabrics are introduced, a service technician will be able to modify existing program cycles accordingly.

Miele will provide information when such possibilities become available.

Optional accessories

Optional accessories are available through your Miele dealer or Miele.

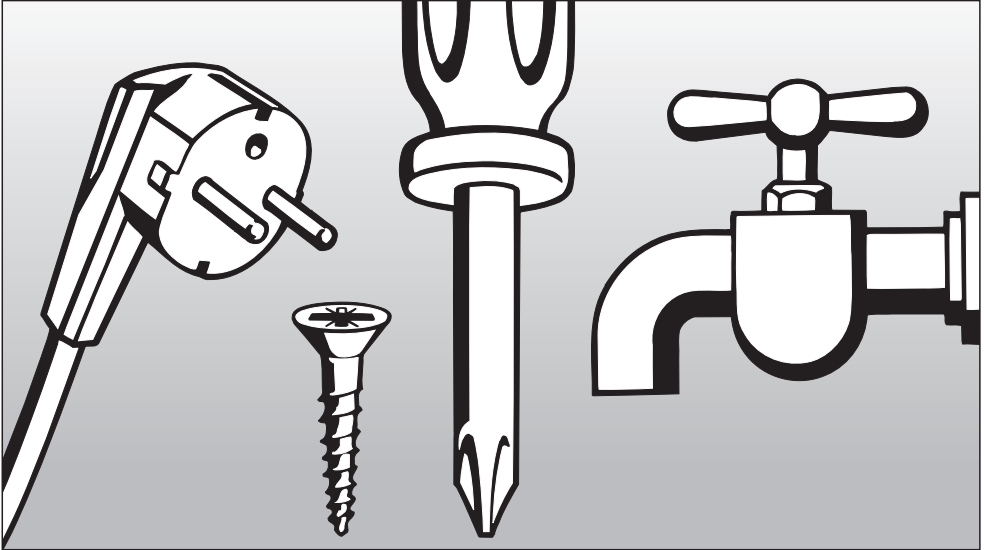

Installation Instructions

To prevent accidents
and machine damage
read these instructions
before
installation or use.

Installation

Front view

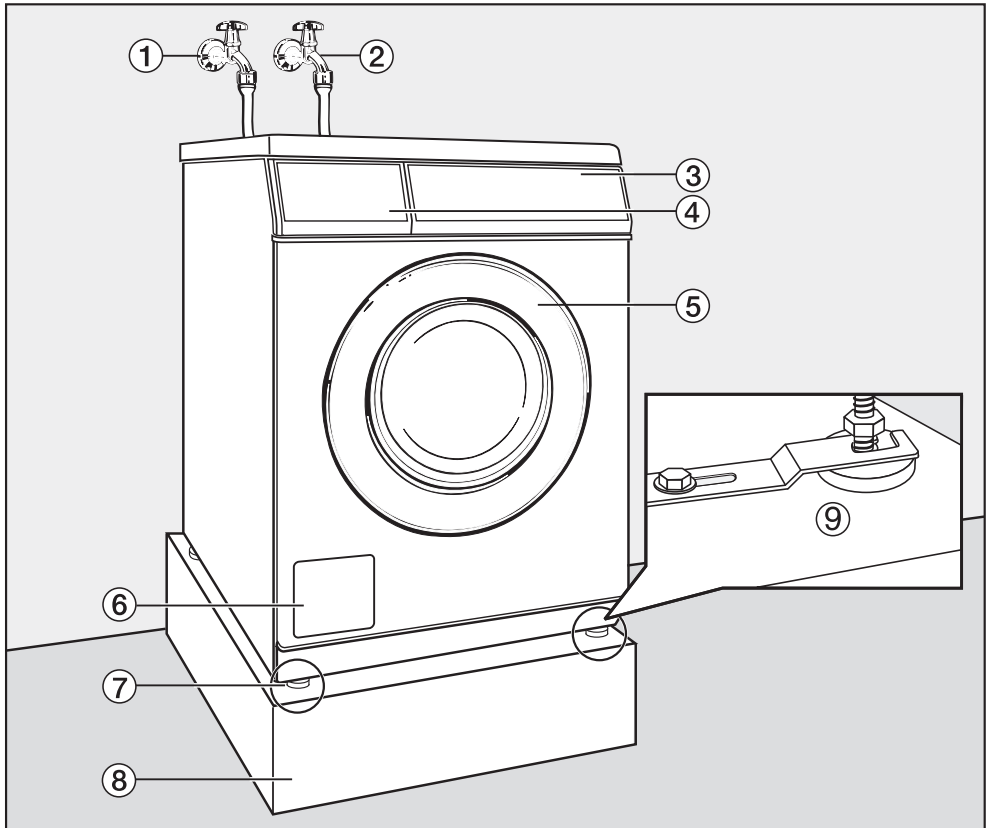

- ① Water intake hose hot
- ② Water intake hose cold
- ③ Control panel
- ④ Detergent dispenser drawer
- ⑤ Drum door
- ⑥ Access panel to drain filter, drain pump and emergency door release
- ⑦ Height adjustable feet
- ⑧ Stand
- ⑨ Fixing bracket (for concrete stand)

Rear view

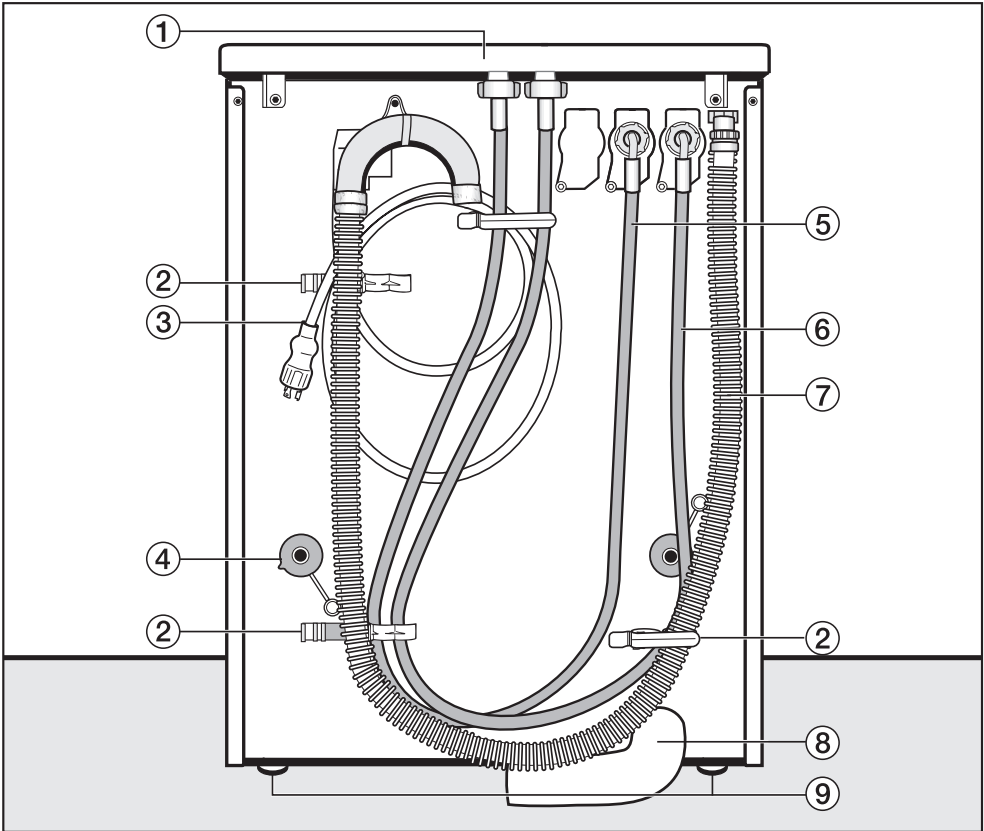

① Lid with transport grips

② Mounting for:

– Water intake hose

– Drain hose

– Withdrawn shipping struts

③ Power cord

④ Shipping struts with rotary protectors

⑤ Water intake hose (cold)

⑥ Water intake hose (hot)

⑦ Drain hose for drain pump

⑧ Drain hose for drain valve
(optional accessory)

⑨ Height adjustable feet

Installation

Installation site

The appliance is not intended to be mounted in a wall or other vertical surface of a building or cabinet. The unit is allowed for built-in application.

 The machine may **not** be operated without the lid in place.

 Do not install the machine directly next to or over an open floor drain or drain channel. Moisture can penetrate the machine and damage electrical parts.

A concrete floor is the most suitable surface for the washer. Concrete floors are less prone to vibration during the spin cycle than wooden floors.

 If the machine is installed on a masonry or concrete base it **must** be secured using the fixing brackets supplied with the machine to prevent the washer from vibrating off the stand during the spin cycle.

- The machine must be leveled and securely positioned.
- To avoid vibration while spinning, the machine should **not be installed** on soft floor coverings.

In case the installation must be on a wooden joist floor:

- Install the unit on a $27 \frac{9}{16}'' \times 23 \frac{5}{8}'' \times 1 \frac{3}{16}''$ (70 x 60 x 3 cm) plywood base. Ideally the base should be large enough to span several joists and should be anchored to the joists and not just the floor boards.

It is best to install the washer in the corner of a room, where the stability of the floor is at its greatest.

Installation

- Use the front washer feet and the rear excess end to transport the washer from its shipping pallet to the installation site.

Do not lift the washer by the drum door.

 Ensure that the machine's feet and the floor are dry to prevent slippage during the spin cycle.

Removing the shipping struts

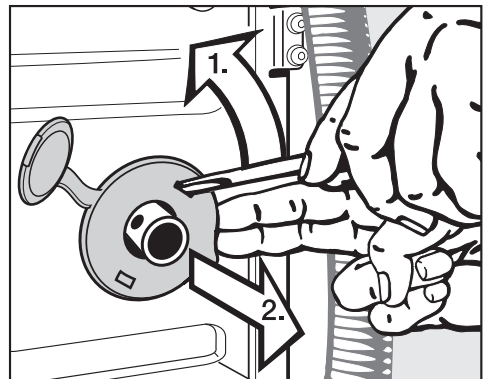

- Remove the left and right rotary protectors.

1. Unhook the rotary protector with a screw driver.
2. Remove the rotary protectors.

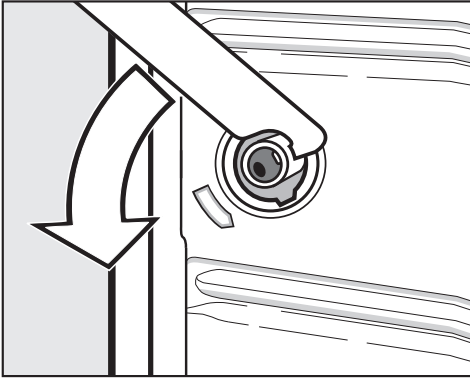

- Turn the left shipping strut counterclockwise 90° with the enclosed combination wrench.

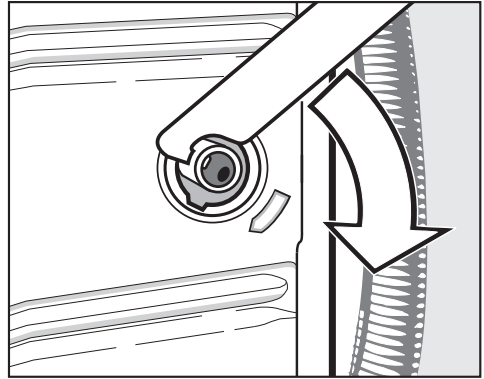

- Turn the right shipping strut clockwise 90° with the enclosed combination wrench.

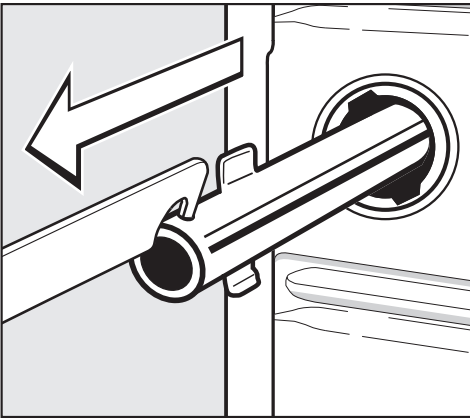

- Pull the shipping strut out.

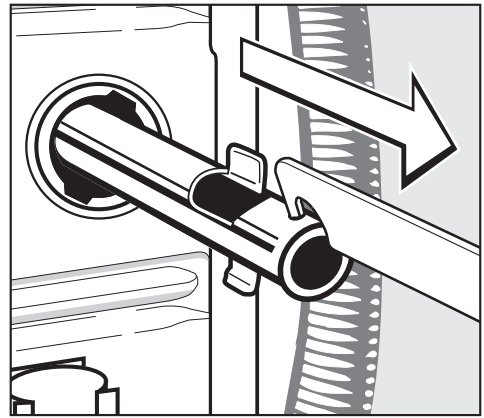

- Pull out the shipping strut out.

Installation

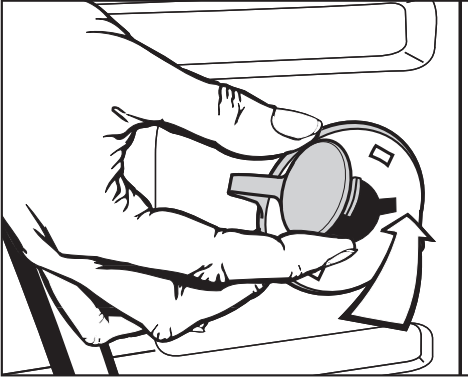

- Close the holes with the rotary protectors and their caps.

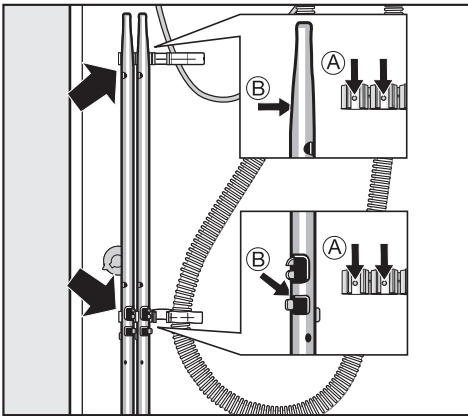

- Fasten the shipping struts at the rear side of the washer. Take care to insert the drill holes, (B), into the clamps, (A).

 Movement of the washer without the shipping struts in place should be kept to a minimum. The shipping struts should be stored on the back of the washer for future use. They must be reinstalled before moving the machine.

Installing the shipping struts

- Reinstall the struts by reversing the installation procedure.

Leveling the washer

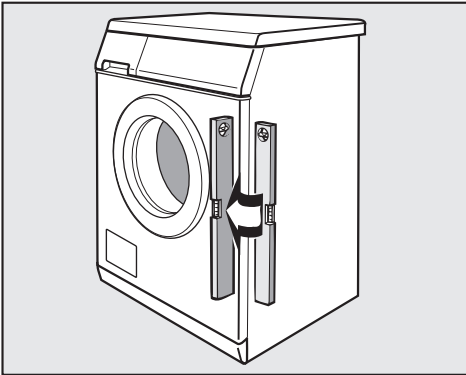

To ensure smooth operation the washer must be level.

Failure to level the machine can result in increased water and energy consumption as well as the washer "banging" during the spin cycle or "walking" across the floor during use.

Adjust the four leveling feet

The washer is leveled by adjusting the four feet. The machine is boxed with the feet completely screwed in.

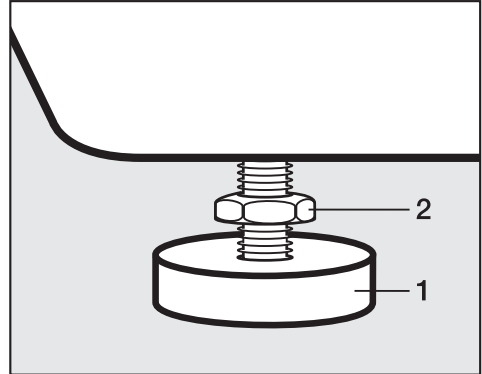

- Turn the locking nut, **2**, counter-clockwise with the enclosed combination wrench. Unscrew each of the four feet as much as necessary by turning both the foot, **1**, and the locking nut, **2**, to the left.
- Check that the machine stands level.
- Once level, hold the foot, **1**, steady with a wrench. Turn the locking nut, **2**, with the combination wrench towards the machine.

 All four locking nuts must be tight against the bottom of the machine. In addition, check to see that the feet were not inadvertently unscrewed while tightening the nuts. Running a machine that is not level or whose feet are not tight may cause damage to both the machine and its surrounding area.

Installation

Washer/ Dryer Stack

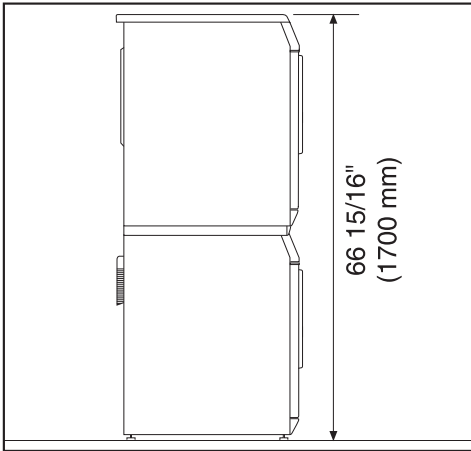

The Miele washing machine can be installed as part of a washer-dryer stack in combination with a Miele tumble dryer. An appropriate stacking kit* is required.

Installation of the stacking kit must be performed by a Miele Service Technician.

Reinstallation of the machine lid

When reinstalling the appliance lid, check the firm fit of the cover at the rear bracket for a safe transport of the dryer.

Installation on a base

The machine can be installed on an open or closed steel base, or on a concrete base. Concrete is recommended.

- Secure the two front feet of the washer with the supplied retaining clips when installing on a concrete base.
- Read the supplied Installation manual.

Coin mechanism

The dryer can be equipped with a coin mechanism*.

The reprogramming necessary for the coin mechanism must be done by a Miele Service Technician.

Empty the coin mechanism regularly. Coins or tokens may get jammed.

Do not install devices to automatically turn the washer off, e.g. a clock timer. The washer must be connected to the power supply to open the door.

The supplied sticker must be affixed at or near by the washer: "This washer must be connected to the power supply to open the drum door. Do not use force to open the door."

* Available from your Miele dealer or Miele.

Water connection

Cold water connection

A water faucet with $\frac{3}{4}$ " thread must be provided on-site. If none is available the machine must be connected to a water line by a qualified plumber.

The water pressure must be between 14.5 -145 psi (1 -10 bar). If the water pressure is greater than 145 psi (10 bar), a pressure reducer must be installed. If the water pressure is below 15 psi (1 bar), there will not be enough water available for a complete fill.

The cold water hose (blue mark) is **not** suitable for a hot water connection.

- Connect the cold water intake hose (blue mark) to the cold water valve.
- Turn on the valve(s) and check for leaks.

The water intake hoses are equipped with screen filters. Do not remove these filters except for cleaning.

Maintenance

Replace the water hoses only with genuine Miele hoses.

Extension hoses

Extension hoses (8' 2" or 13' [2.5 m or 4 m]) may be obtained from Miele.

Installation

Hot water connection

Connecting the machine to a hot water supply will lead to low electrical consumption during hot water operation. The hot water temperature at the water supply must not exceed 158°F (70°C).

The water in single water lines from the hot water source cool faster when not in constant use. To heat the wash water more electricity must be used. The same conditions for the hot water as for the cold water connection will then apply.

- Connect the hot water intake hose (red mark) to the water supply.

The connection of the machine to a hot water line only, is not possible for functional reasons.

If the washer is not to be installed for hot water connection, the settings "Main wash", "Pre-wash" and "Rinse" must be adjusted respectively. The hot water intake hose must be removed.

- Select in "Settings - Supervisor level" the respective extras "cold".

The program times may be extended.

- Unscrew the hot water intake hose (red mark).
- Screw on the supplied stopper.

Drainage

There are two drainage extras for this machine:

Drain valve

The machine is drained with a motorized drain valve. A connection can be made to an on-site floor drain (gully with an air gap) on an angle.

Drain pump

The wash water is drained using a pump with a 3 ft (1 m) delivery height. Make sure there are no kinks in the drain hose. The elbow on the end of the drain hose can be turned or removed if necessary.

Possible connections:

- 1. Directly into a sink:** Hook the hose over the edge of the sink and secure it firmly (e.g. by tying the hose to the water faucet).
- 2. To a stand pipe:** Place the drain hose into a 1 $\frac{1}{2}$ " (4 cm) stand pipe and secure it firmly.
- 3. To a floor drain:** The machine is equipped with an air gap/anti-siphoning system so that no minimum drain height is required.

If necessary the drain hose can be extended up to 16' 5" (5 m). The hose extension can be purchased from your Miele dealer or Miele.

Installation

Electrical connection

 This installation should be performed by an experienced and qualified technician, in accordance with local codes and regulations.

The washer comes with a power cord and NEMA L6-30 plug.

The machine is supplied as standard for connection to a 208/240 V, 60 Hz, 30 A, 2-phase electrical supply.

For extra safety it is advisable to install a residual current device (RCD) with a trip current of 30 mA.

The machine must only be connected to the voltage and frequency shown on the data plate.

 Do not install devices to automatically turn the washer off, i.e. a clock timer.

Technical Data

Height	33 7/16" (85 cm)
Width	23 7/16" (59.5 cm)
Depth	28 3/8" (72 cm)
Depth with the door open	44 1/8" (112 cm)
Weight	240 lbs (109 kg)
Maximum floor load	613 lb [2778 Newton (approx. 278 kg)]
Capacity	14.3 lbs (6.5 kg) dry laundry
Fuse rating	see data plate
Rated load	see data plate
Noise level during spinning (Noise emission 3. GSGV)	< 70 dB(A)
Minimum water flow pressure	14.5 psi (1 bar)
Maximum water pressure	145 psi (10 bar)
Length of intake hose	5'3" (1.6 m)
Length of power cord	5'3" (1.6 m)
Drain height maximum (Drain pump)	3'3" (1 m)
LED lighting for drum	Class 1

Help to protect the environment

Disposal of the packing materials

The cardboard box and packing materials protect the appliance during shipping.

To prevent suffocation of children ensure that any plastic wrapping, bags, etc. are disposed of safely and kept out of the reach of children.

Please recycle.

Disposal of an old appliance

Old appliances may contain materials that can be recycled. Please contact your local recycling authority about the possibility of recycling these materials.

Ensure that the appliance presents no danger to children while being stored for disposal. Before discarding an old appliance, unplug it from the outlet, cut off its power cord and remove any doors to prevent hazards.

Menu Settings to adjust standard settings

The washer controls can be adjusted to changing demands through the settings menu.

Settings

Opening the menu Settings

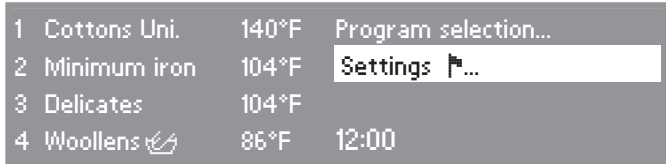

- Select the "Settings"  in the main menu and confirm by pressing the jog shuttle.

Selecting Settings

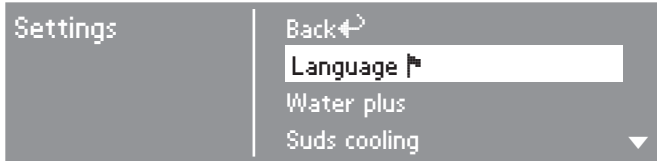

- Select the settings to be changed and confirm.

If no selection was made in the submenu, the display will switch back to the "Settings" menu after 20 seconds.

Leaving the Settings menu

- Press "Back" and confirm. The display shows the main menu.

Language

The display contents can be shown in different languages.

The displayed language can be set in the submenu "Language" .

- Select the desired language and confirm with "OK".

The flag behind the word "Language" is a guide to find the settings menu in case a foreign language is shown.

If the language setting was changed, it is only valid for the current wash program. Once the program ends, the display will show the language which is set under "Settings - Supervisor level".

Suds cooling

Cold water is added at the end of the main wash to cool the wash water.

Suds cooling is carried out when a wash temperature of 158°F (70°C) or more is selected.

Suds cooling should be activated when the drain hose is hung into a sink, to prevent scalding.

Suds cooling is factory set turned on.

Time of day

The selection allows the clock to be shown as 24 hours, 12 hours or not at all. The time of day is also set here.

If the clock is not selected the timer can only be shown as a 24 hour clock timer. The display will show the timer counting down until the start of the program but not the current time of day.

Selecting the clock

- Select the clock display and confirm.

The display changes to the time of day setting.

Set the time of day

- Select the current hour with the jog shuttle and confirm. Repeat with setting the minutes and confirm. Press again to save the time of day.

Contrast / Brightness

The contrast / brightness of the display can be set at ten different levels.

The contrast / brightness changes immediately when a different level is selected.

- Confirm the setting with the jog shuttle.

Standby

The display goes out after 10 minutes and the "Start" button flashes slowly to save energy.

By turning the jog shuttle or pressing any button the display is turned on again.

On

The display will go into Standby mode:

- if no program is selected after the machine is turned on.
- after a program has started.
- at the end of a program.

Not in current prog. (default)

The Standby function will be turned on if no program is selected after the machine is turned on.

Off

The display stays on.

Memory

The Memory function remembers the addition of an extra feature to a program, a change in spin speed or temperature the next time that program is selected.

Once the wash program is selected again the washer shows the saved extras.

The memory function is not active when favorites are selected with the direct select buttons.

The Memory function is factory set "off".

Temperature unit

The temperature can be shown in "°C/Celsius" (factory default) or "°F/Fahrenheit".

- The delivery status is "°C".

Settings - Supervisor level

The menu Settings - Supervisor level must be activated by Technical Service.

The menu "Settings" (except Languages ) is locked with a code to prevent unwanted access.

Selecting Settings

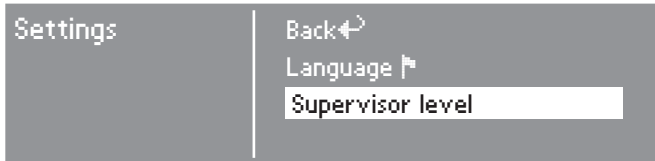

- Select "Supervisor level" and confirm.



- Select "Access via code" and confirm.

Entering the code

- Enter the code "0 0 0" (factory default).
If a wrong code is entered three times, the code entry will be locked for 1 hour.



- Turn the jog shuttle until the first digit shows. Confirm the digit. Enter the second and third digit.

Settings - Supervisor level

Confirming the code



- Confirm the entered code.



The user is now in the "Supervisor level". The previously described settings and all of the following settings can be changed.

Change the code to prevent unauthorized access to the settings.

Language

The display contents can be shown in different languages.

The fixed default language can be set in the submenu "Language .

- Select the desired language and confirm with "OK".

Sort languages

The order of the first 4 languages in the display can be set, when the option "Language menu - international" or "Language menu - International 4" is selected.

Supervisor level

The access code for the supervisor level can be changed.

- Enter the old code.
- Enter the new code.

Once the new code is confirmed, the display will show the beginning of the "Settings" menu.

Favorites

The 12 programs of the basic menu for the operating variation "WS-KW-Button + Logo" can be configured (only in conjunction with the setting "Controller" option "WS-KS-Buttons + Logo").

The programs can be selected from the complete machine program range. The first 3 programs of this list are allocated to the direct select buttons 1 to 3.

Example for changing a program in the list:

- Select the setting "Favorites" and confirm.
- Select a program from the list.
- Change one or more components (program name, temperature, spin speed, pre-wash).
- Press the direct select button "Save".

The program is saved in the list.

Settings - Supervisor level

Logo

The Miele Professional logo or your own logo can be displayed. (Only in conjunction with the setting "Controller option "WS-KW-Buttons + Logo").

The Miele Professional logo is shown by default.

Language menu

This option allows you to display an additional welcome screen which requests a language selection. The screen can be shown before the main menu or after the end of a wash program.

Three selections are available:

- National: no additional welcome screen (default).
- International: Welcome screen shows, an additional language has to be selected. Select from all languages. Note the setting "Sort languages".
- International 4 languages: Welcome screen shows, an additional language has to be selected. Select from four languages. Note the setting "Sort languages".

Intensive Water plus

You can select if the extras "Intensive" and "Water plus" are shown in the menu "Extras".

The option is factory set to "off".

Water plus

In the setting "Water plus" you can select the settings for the Extra "Water plus".

You can select from three options.

Water plus: (default)

The water level increases (more water) in the wash and rinse cycles of the programs: "Cottons Hygiene", "Cottons Uni." and "Minimum iron", "Silk" and "Table linen".

Additional rinse

An extra rinse cycle is added in the programs "Cottons Hygiene", "Cottons Uni." and "Minimum iron".

Water+ and Add. rinse

The water level is increased in the wash and rinse cycles and an extra rinse cycle is added to the programs "Cottons Hygiene", "Cottons Uni." and "Minimum iron", "Silk" and "Table linen". An additional rinse cycle is added in the programs "Cottons Hygiene", "Cottons Uni." and "Minimum iron".

Save

The option "Save" can be shown in the basic menu. The function "Save" is needed to save, for example, the favorite wash programs on the direct select buttons.

The machine comes factory set with this option turned off.

Auto load control

The water levels and the program running times are automatically adjusted to the load size. If the auto load control is turned off the program will run as if for a full load.

The machine comes factory set with this option turned on.

Settings - Supervisor level

Pre-wash water

The water type for the pre-wash can be selected (except for the program "Woolens, Silk, Curtains and Proofing"). The hot water intake will be only accessible at a wash temperature of 86°F (30°C) or higher.

This option is set to "hot" by default.

Main wash water

The water type for the main wash can be selected (except for the programs "Woollens", "Silk" "Curtains" and "Proofing"). The hot water intake will be only accessible at a wash temperature of 86°F (30°C) or higher.

This option is set to "hot" by default.

If the washer is not connected to hot water, the program running times will be extended and vary from the displayed remaining times.

If "Recycled water" is used, the washer must be refitted accordingly.

Rinse water

The water type for the rinse in the programs "Cottons Hygiene", "Cottons Uni.", "Minimum iron", "Kitchen linen", "Toweling" and "Sluice" can be selected. The hot water intake will be only accessible at a wash temperature of 50°C or higher.

This option is set to "hot" by default.

If "Recycled water" is used, the washer must be refitted accordingly.

Low water pressure

If the water pressure is always below 14.5 psi this setting can be activated to ensure trouble free water intake.

This option is set to "Off" by default.

Settings - Supervisor level

Water level Cottons

The program "Cottons Hygiene" and "Cottons Uni." allows you to increase the water level for the main wash.

This option is set to "Block Parameter" by default. (The water level will be controlled by the default program data.)

Pre-wash duration Cottons

The programs "Cottons Hygiene" and "Cottons Uni." allow to extend the wash time for the pre-wash.

This option is set to "Block Parameter" by default. (The pre-wash time will be controlled by the default program data.)

Water level Min. iron

The program "Minimum iron" allows you to increase the water level for the main wash.

This option is set to "Block Parameter" by default. (The water level will be controlled by the default program data.)

Wash time Cottons

The programs "Cottons Hygiene" and "Cottons Uni." allow you to extend the wash time for the main wash.

This option is set to "Block Parameter" by default. (The main wash time will be controlled by the default program data.)

Pre-wash temp. Cot.

The Pre-wash temperature for the programs "Cottons Hygiene" and "Cottons Uni." can be selected.

This option is set to "Block Parameter" by default. (The temperature will be controlled by the default program data.)

Wash time Min. iron

The program "Minimum iron" allows you to extend the wash time for the main wash.

This option is set to "Block Parameter" by default. (The main wash time will be controlled by the default program data.)

Settings - Supervisor level

No. of programs

Additional programs can be added to the program selection.

- 0 Additional programs (default)
- 4 Additional programs ("Table linen", "Pillows", "Curtains" and "Kitchen linen")
- 2 Additional programs ("Outerwear" and "Proofing")
- 6 Additional programs (all of the above programs).

Quick wash

The program "Quick wash" can be added to the program list.

This program is added by default.

Hygiene

If the last used program had a temperature of 131°F (55°C) or less, the display shows the request to start the "Hygiene" program.

This option turned off by default.

Sluice

The "Sluice" programs will be added to the program list when this option is selected.

These programs are not added by default.

Disinfection

Special disinfection programs can be added.

- 0 Additional programs (default)
- 4 Additional programs (Thermal disinfection 15 min/185°F (85°C), Chemothermal disinfection 10 min/158°F (70°C), Chemothermal disinfection 20 min/140°F (60°C) Chemothermal disinfection 30 min/104°F (40°C)).

Pre-wash

In the programs "Cottons Hygiene", "Cottons Uni." and "Minimum iron" a pre-wash can be permanently added to the cycle or it can be selected in the menu "Extras".

This option is set to "Menu selection" by default.

2nd pre-wash Kitchen linen

The program "Kitchen linen" allows an additional pre-wash.

- Add the detergent for the additional pre-wash directly in the drum.

This option is set to "off" by default.

No. rinses Cottons

The programs "Cottons Hygiene" and "Cottons Uni." allow to change the number of rinse cycles.

- 2 rinses (default)
- 3 rinses
- 4 rinses
- 5 rinses

No. rinses Min. iron

The program "Minimum iron" allows you to change the number of rinses.

- 2 rinses (default)
- 3 rinses
- 4 rinses

Pre-rinse Cottons

The programs "Cottons Hygiene" and "Cottons Uni." allows you to add a pre-rinse.

This option is set to "off" by default.

Pre-rinse Min. iron

The program "Minimum iron" allows you to add a pre-rinse.

This option is set to "off" by default.

Anti-crease

An anti-crease program can be added at the end of a program.

This option is set to "on" by default.

Settings - Supervisor level

Spin free of charge

When operated by a coin mechanism, the program "Spin" can be activated free of charge.

This option is set to "off" by default.

Lock

If a coin mechanism is connected the washer can be locked immediately or 3 minutes after starting a program.

You can select from four options:

immediately

The washer is locked immediately.

after 3 minutes

The washer will be locked 3 minutes after the program start (default setting).

immediately, with cancel option

The washer is locked immediately. If the Start button is pressed for 4 seconds the display shows "Cancel". Canceling is possible up to 3 minutes after starting a program.

after 3 minutes, with cancel option

The washer is locked after 3 minutes. If the Start button is pressed for 4 seconds the display shows "Cancel". Canceling is possible up to 3 minutes after starting a program.

External dispenser

The washer is set for connection to an external dispensing system. To use the external dispensing system the setting must be adjusted/set accordingly.

This option is set to "off" by default.

No detergent

If an external dispensing system is fitted to the machine it will not be accessed if "No detergent" is selected. You have the option to show the extra "No detergent" in the menu "Extras".

This option is set to "off" by default.

Temp. reduction

To avoid premature boiling of the wash water at altitudes over 9842 ft (3000 m) in the sanitize program, the wash water temperature can be lowered by 41°F (5°C).

This option is set to "off" by default.

Settings - Supervisor level

Controls

The "Operating variant" of the machine can be adjusted.

Caution: When selecting "WS-KW-Buttons simple" or "WS-KW-Buttons + Logo" the "Settings" component will not be offered any longer once the menu "Settings/Supervisor level" is closed. The "Supervisor level" cannot be accessed any longer. Contact Technical Service if you would like to change more settings.

D-with speed dial buttons (default setting).

CH-with speed dial buttons (adjusted program allocation).

GB-without speed dial buttons (limited program selection, operation available only by jog shuttle).

D-without speed dial buttons (limited program selection, operation available only by jog shuttle).

WS-with KW buttons simple
Only 4 pre-selected (favorite) programs are offered, which cannot be changed by the user.

- Set the 4 favorite programs first, before activating this variant. See "Favorites".

GB-with speed dial button (adjusted program allocation).

GB-with KW-buttons Sluice (adjusted program allocation).

WS-KW-Buttons + Logo
(special operating variant for Laundromat owners).

The wash programs for the basic program menu in the option "WS with KW-Buttons + Logo" are configured in the setting "Favorites". You can add your own logo. See "Logo".

Delay Start

The end of the program can be selected with the timer. See "Timer" for more info. The timer can be set "active" or "inactive" (no function).

"Inactive" (default setting) shows only the program duration, the estimated time of day at the program end and the current time of day when the "Timer" button is pressed.

Leaving the Settings menu

- Press "Back" and confirm. The display shows the main menu.

**When contacting the Technical Service,
please quote the model and serial number
of your appliance.**



Miele, Inc. (USA)

National Headquarters

9 Independence Way
Princeton, NJ 08540
Phone: 800-843-7231
609-419-9898
Fax: 609-419-4298
www.miele.com

**Technical Service & Support
Nationwide**

Phone: 800-999-1360
Fax: 888-586-8056

Miele Limited (CDN)

Headquarters and Showroom

161 Four Valley Drive
Vaughan, ON L4K 4V8
Phone: 800-643-5381
905-660-9936
Fax: 905-532-2290
www.miele.ca
info@miele.ca (general enquiries)
professional@miele.ca (commercial enquiries)

MieleCare National Service

Phone: 800-565-6435
905-532-2272
Fax: 905-532-2292
service@miele.ca (technical enquiries)