

42" 6-Burner Gas Cooktop

KM 3485



42" 6-Burner Gas Cooktop

KM 3485



KM 3485

Features:

- 6 completely sealed burners:
 - (1) 16,500 BTU Double inset super burner
 - (1) 15,300 BTU Double inset super burner
 - (2) 12,000 BTU Super burners
 - (2) 9,000 BTU High-speed burners
- Side control panel
- Stainless steel knobs
- Fast ignition system
- Ignition safety control
- Wok ring included

SPECIFICATIONS

KM 3485 G - Item# 26348550USA

KM 3485 LP - Item# 26348551USA

Unit Width 42¹/₂" (1079 mm)

Unit Height (To Gas Connection) 3¹/₄" (83 mm)

Unit Depth 21⁵/₁₆" (542 mm)

Niche

Cut-Out Dimensions 41¹/₂" (1054 mm) W x 20³/₈" (518 mm) D

Minimum Back Spacing From Wall 2³/₄" (70 mm)

Minimum Countertop Thickness 1³/₁₆" (20 mm)

Minimum Recommended distance to ventilation hood 30" (760 mm)

Gas Burners

Normal Burner (2) 9,000 BTU (G/LP)

Fast Burner (2) 12,000 BTU (G/LP)

Wok Burner (Left) (1) 15,300 BTU (G/LP)

Wok Burner (Right) (1) 16,500 BTU (G/LP)

Total Maximum BTU Output 73,800 BTU (G/LP)

Gas

Gas Connection 1/2" NPT

Maximum Gas Supply Pressure Natural Gas - 14" WC (34.9 mb), 1/2 psi (3.5 kPa)
LP Gas - 14" WC (34.9 mb), 1/2 psi (3.5 kPa)

Minimum Gas Supply Pressure Natural Gas - 6" WC (15 mb)
LP Gas - 10" WC (25 mb)

Electrical

Electrical Requirements 120 V, 60 Hz, 15 A

Power Cord NEMA 5-15P, 4 ft (1.2 m)

Shipping

Shipping Weight 75 lbs (34 kg)

Shipping Dimensions 45¹¹/₁₆" W x 7⁷/₈" H x 23⁵/₈" D

Support

Call 800.843.7231

Miele Website www.mieleusa.com

20/20 Link 2020technologies.com

42" 6-Burner Gas Cooktop KM 3485



PRODUCT OVERVIEW

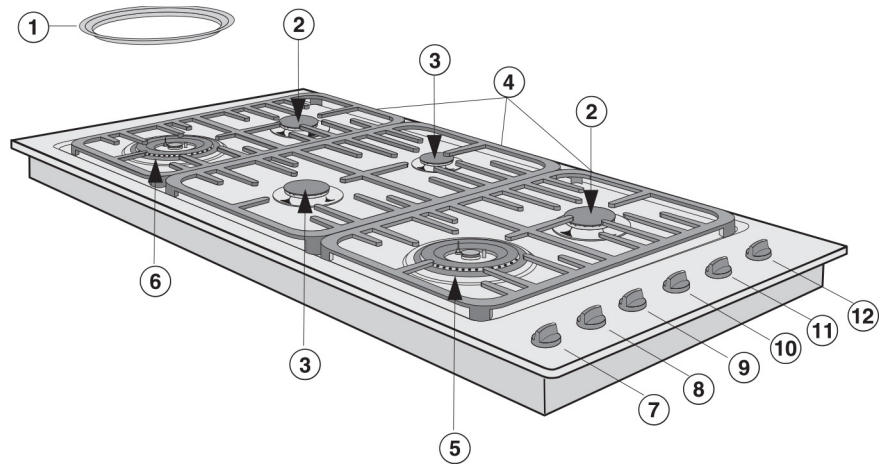

- ① Wok ring
 - ② Normal burners
 - ③ Fast burners
 - ④ Grates
(Design depends on model)
 - ⑤ Wok burner large
 - ⑥ Wok burner small
- Control Knobs:
- ⑦ Front right burner
 - ⑧ Front center burner
 - ⑨ Front left burner
 - ⑩ Right rear burner
 - ⑪ Center rear burner
 - ⑫ Left rear burner

42" 6-Burner Gas Cooktop KM 3485



INSTALLATION DIMENSIONS

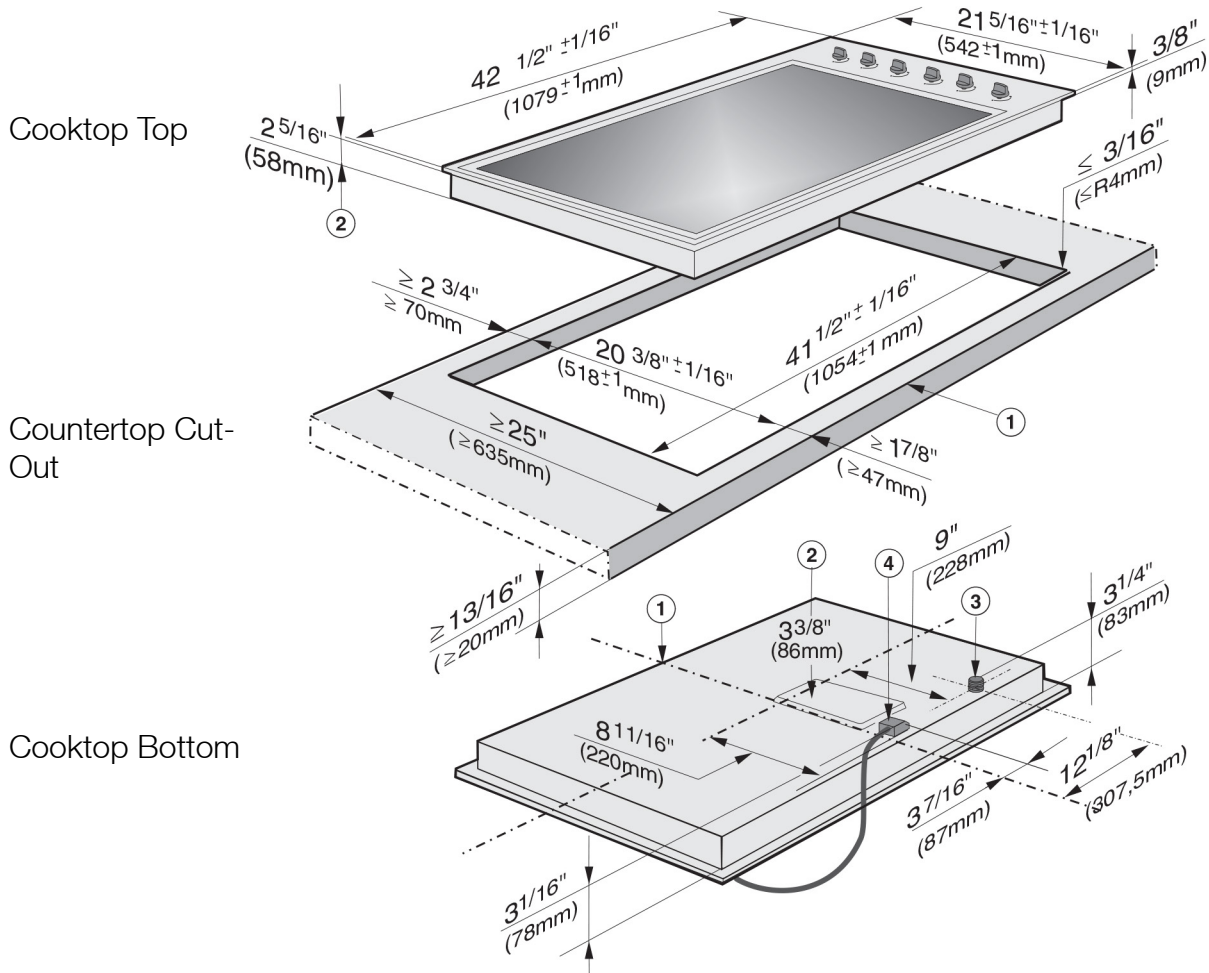

- ① Front
- ② Built-in depth
- ③ Gas connection R $\frac{1}{2}$ " NPT
- ④ Mains connection box

42" 6-Burner Gas Cooktop KM 3485



KM 3485 GAS COOKTOP INSTALLATION IN COMBINATION WITH UNDERCOUNTER 30" MIELE OVEN H6x80BP

Countertop Thickness vs. Toekick Height

Taken into consideration:

- 35" tall cabinetry
- Gas pressure regulator mounted on back wall or in adjacent cabinetry
- 90 degree street elbow used on bottom of cooktop
- $\frac{3}{8}$ " of cooktop above countertop (proud)
- $\frac{3}{4}$ " (exact) platform thickness under oven/above toekick

		Toekick Height (Inches)										
		$3\frac{1}{2}$	$3\frac{3}{4}$	4	$4\frac{1}{4}$	$4\frac{1}{2}$	$4\frac{3}{4}$	5	$5\frac{1}{4}$	$5\frac{3}{4}$	6	
Countertop Thickness (Inches)	$\frac{13}{16}$	NA	NA	NA	NA	NA	NA	NA	NA	NA	NA	NA
	1	OK	NA	NA	NA	NA	NA	NA	NA	NA	NA	NA
	$1\frac{1}{4}$	OK	OK	NA	NA	NA	NA	NA	NA	NA	NA	NA
	$1\frac{1}{2}$	OK	OK	OK	NA	NA	NA	NA	NA	NA	NA	NA
	$1\frac{3}{4}$	OK	OK	OK	OK	NA	NA	NA	NA	NA	NA	NA
	2	OK	OK	OK	OK	OK	NA	NA	NA	NA	NA	NA

 = Standard Kitchen