

# Miele

## Operating instructions



### Oven

H 387-1 BP KAT

H 387-2 BP KAT

To prevent accidents  
and machine damage,  
read these instructions  
**before** installation or use.



M.-Nr. 05 712 991

# Contents

---

<b>IMPORTANT SAFETY INSTRUCTIONS</b> . . . . .	4
<b>Guide to the oven</b> . . . . .	8
Accessories . . . . .	9
Roasting pan and Anti-splash tray . . . . .	9
Wire rack and baking trays . . . . .	9
Grease filter . . . . .	10
Roast probe . . . . .	10
Rotisserie . . . . .	10
Slide opener . . . . .	10
Controls . . . . .	11
<b>Safety Locks</b> . . . . .	12
<b>Before using for the first time</b> . . . . .	13
<b>Using the oven</b> . . . . .	14
Interrupting cooking / turning off the oven. . . . .	14
Adjusting the default temperature . . . . .	15
Entering the time of day . . . . .	17
To conceal the time of day . . . . .	17
To make the time visible . . . . .	17
Programming the cooking time . . . . .	18
To program a cooking time to end automatically . . . . .	19
To enter a cooking length and a time for the oven to shut off. . . . .	19
Enter the start time and the length of cooking . . . . .	20
Checking, changing and canceling times entered . . . . .	20
To cancel a program . . . . .	21
Entering a cooking time . . . . .	22
Checking, changing and deleting a cooking time . . . . .	22
Rapid heat . . . . .	23
To turn off "rapid heat". . . . .	23
Customizing a temperature setting . . . . .	24
Energy-Conservation feature . . . . .	25
Oven lighting . . . . .	25
Night dimming . . . . .	25
<b>Setting the timer</b> . . . . .	26

<b>Guide to the programs</b> . . . . .	27
<b>Baking</b> . . . . .	28
<b>Roasting</b> . . . . .	31
Roasting tips . . . . .	32
<b>Using the roast probe</b> . . . . .	33
<b>Roasting Recommendations</b> . . . . .	36
<b>Broiling</b> . . . . .	37
Broiling tips . . . . .	40
<b>Broiling chart</b> . . . . .	41
<b>Defrost</b> . . . . .	42
Defrosting tips . . . . .	42
<b>Cleaning and care</b> . . . . .	43
Accessories . . . . .	43
PerfectClean . . . . .	44
Oven interior . . . . .	45
Removing the oven door. . . . .	47
Removing the runners. . . . .	48
Lowering the upper heating element . . . . .	48
<b>Changing the light bulb</b> . . . . .	50
<b>Turning additional features on or off</b> . . . . .	51
<b>Frequently asked questions</b> . . . . .	52
<b>After sales service</b> . . . . .	55
<b>Optional accessories</b> . . . . .	56
<b>Installation instructions</b> . . . . .	59
<b>Caring for the environment</b> . . . . .	60
Disposal of the packing materials . . . . .	60
Disposal of an old appliance . . . . .	60
<b>Electrical connection</b> . . . . .	61
<b>Installing the oven</b> . . . . .	62

# IMPORTANT SAFETY INSTRUCTIONS

---

This appliance is intended for residential use only.

Only use the appliance for its intended purpose. The manufacturer cannot be held responsible for damages caused by improper use of this oven.

This appliance complies with current safety requirements. Improper use of the appliance can lead to personal injury and material damage.

Read all instructions before installing or using the oven for the first time.

Keep these operating instructions in a safe place and pass them on to any future user.

## Installation

■ Before installation, make sure that the voltage and frequency listed on the data plate correspond with the household electrical supply. This data must correspond to prevent injury and machine damage. Consult a qualified electrician if in doubt.

■ Be certain your appliance is properly installed and grounded by a qualified technician.

To guarantee the electrical safety of this appliance, continuity must exist between the appliance and an effective grounding system. It is imperative that this basic safety requirement be met. If there is any doubt, have the electrical system of the house checked by a qualified electrician.

The manufacturer cannot be held responsible for damages caused by the lack, or inadequacy, of an effective grounding system or the failure to adhere to national and local electrical codes.

■ The oven is not to be operated until it has been properly installed within cabinetry.

■ Installation, maintenance and repair work should be performed by an authorized service technician. Work by unqualified persons could be dangerous and may void the warranty.

■ Before installation or service, disconnect the power supply to the work area by "tripping" the circuit breaker, or shutting off the power main.

# IMPORTANT SAFETY INSTRUCTIONS

---

## Oven use

 **WARNING:** Ovens can produce high temperatures that may cause burns.

 Prevent children from touching the appliance when in use.

 Use heat-resistant pot holders when placing items in the oven, turning them, or removing them from the oven. The upper heating element and oven racks can become very hot and cause burns.

 To prevent burns, always place oven racks at their desired height while the oven is cool.

 Always open the door carefully. Allow hot air or steam to escape before placing or removing food.

 To prevent burns, allow the heating element to cool before cleaning by hand.

 Only clean parts listed in this manual.

 Caution: Heating elements may be hot even though they are not glowing. During and after use, do not let clothing or other flammable materials come in contact with heating elements or interior surfaces of the oven until they have had sufficient time to cool. External parts of the oven such as the door glass, vents, and control panel may also become hot.

 The door gasket is essential for a good seal. Care should be taken not to rub, damage or move the gasket. The door gasket should only be cleaned with a solution of warm water and soap.

 Do not block oven vents.

 Do not let metal objects (aluminum foil, metal pans) or the meat probe come in contact with the heating element.

 Do not slide pots or pans on the oven floor. This could scratch and damage the surface.

 Do not lean, sit, or place heavy items on the open oven door. The door can support a maximum weight of 33 lbs (15 kg).

# IMPORTANT SAFETY INSTRUCTIONS

---

Do not heat unopened containers of food in the oven, pressure may build up and cause them to explode.

Never add water to food on a hot tray or pan or directly onto food in a hot oven. The steam created could cause serious burns or scalds and the sudden change in temperature can damage the enamel.

This oven must only be used for cooking. Do not use it as a dryer, kiln, dehumidifier, etc. Fumes or vapors given off by glues, plastics or other non-food items could ignite and cause property damage or injury.

Cover all cooked food that is left in the oven to be kept warm. This will prevent moisture from condensing on the interior of the oven. Long-term or excessive condensation could damage the oven.

Only use the Miele roast probe supplied with the oven. Contact Miele if you need to purchase a new probe.

Remove the roast probe from the oven when not using it. High broiling temperatures could damage the probe.

Never use aluminum foil to line the oven floor or place pots, pans or baking sheets directly on the oven floor when using "Surround", "Bottom Heat" or "Intensive". This could crack the enamel on the oven floor.

Never store flammable liquids and materials in, above or under an oven, or near cooking surfaces.

During the Self Clean program the front of the oven becomes warmer than with normal oven use. Do not touch the oven door. There is a risk of burns.

Remove all accessories including the runners and any extra accessories from the oven before starting the Self Clean program. The high temperatures needed for this program will damage the accessories and cause irreparable damage.

# IMPORTANT SAFETY INSTRUCTIONS

---

## General notes

- Do not use a steam cleaner to clean the oven. Steam could penetrate electrical components and cause a short circuit.
- Children should not be left alone or unattended in an area where an oven is in use. Never allow children to sit or stand on any part of the oven. Caution: Do not store items of interest to children in cabinets above an oven. Children climbing on the oven to reach these items could be injured.
- Do not leave the oven unattended when cooking with oils or fats, they can be a fire hazard if overheated.
- Do not use water on grease fires! Smother the fire with a properly rated dry chemical or foam fire extinguisher.
- Be aware of loose fitting or hanging garments while operating the oven.
- Do not use the oven to heat the room.
- Make certain that the power cords of small appliances do not come in contact with or get caught in the oven door.
- Use only dry, heat resistant potholders. Moist or damp potholders used on hot surfaces may result in steam burns. Do not let potholders come in contact with oils. Do not substitute towels or other bulky items for potholders.

## Disposal of an old oven

- When discarding an old oven, disconnect it from the power supply and cut off the power cord. Remove the door to prevent trapping hazard.

# Guide to the oven

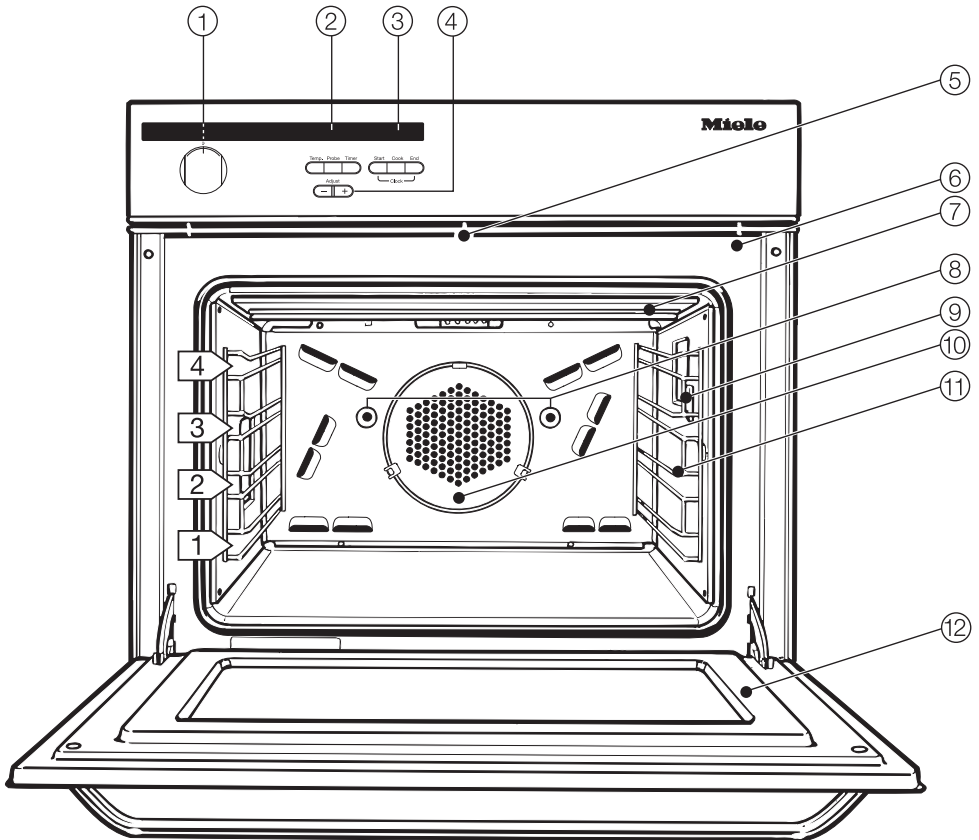

- ① Program selector
- ② Oven display and push buttons
- ③ Clock/Timer display and push buttons
- ④ "+/-" adjust buttons
- ⑤ Self Clean Safety Lock
- ⑥ Door contact switch\*
- ⑦ Upper heating element
- ⑧ Rotisserie motors
- ⑨ Roast probe socket
- ⑩ Convection fan
- ⑪ Non-tip, four level runners
- ⑫ Oven door

\*This switch shuts off the heating element and convection fan when the door is opened during use.



## Accessories

### Roasting pan and Anti-splash tray

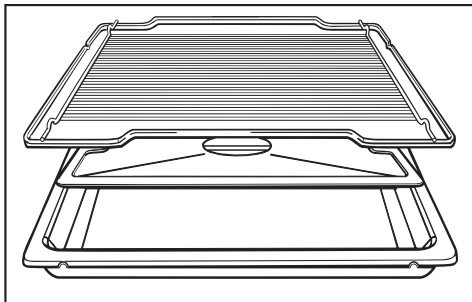

The roasting pan is ideal for catching drippings from meat or poultry roasted or broiled directly on the rack.

It can also be used as a baking tray.

The anti-splash tray may be placed in the roasting pan to reduce splattering of drippings from meat or poultry.

The roasting pan and anti-splash tray are coated with PerfectClean enamel and can be easily cleaned with a sponge and dish soap.

### Wire rack and baking trays

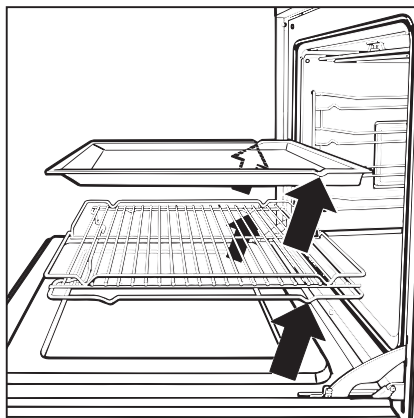

The oven comes equipped with a wire rack and two baking trays. The trays are to be slid into the runners on either side of the oven rather than on the wire rack itself.

### Non-tip safety notches

The wire rack, roasting pan and baking trays are equipped with non-tip safety notches (see arrows) which prevent them from being pulled out completely while the oven is in use.

When inserting a rack, pan or tray always check that the safety notches are at the rear of the oven.

Once inserted into the oven these pieces can only be removed by raising the piece upwards and then pulling it out.

# Guide to the oven

## Grease filter

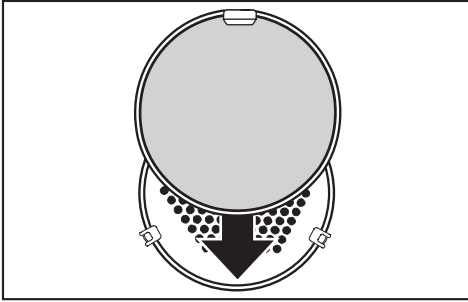

The filter helps to keep the oven fan clean from moisture and grease.

When roasting or broiling, insert the grease filter in front of the fan opening.

## Roast probe

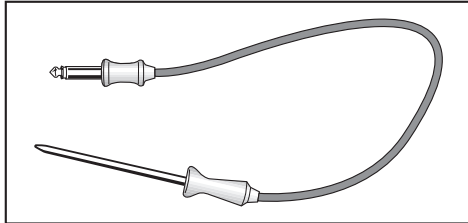

The roast probe monitors the core temperature of meat and poultry during a roasting function.

The long pointed end of the probe is inserted into the thickest portion of the meat while the short end of the probe is inserted into the roast probe socket.

## Rotisserie

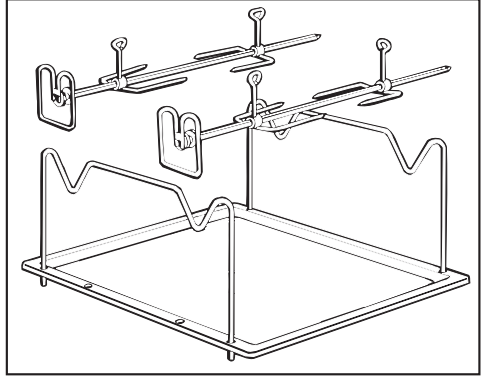

The rotisserie evenly broils and adds a finishing touch to items such as stuffed meat, poultry, and kabobs by gently turning the skewers during the broiling function.

The skewers are inserted into the rotisserie motor in the back panel.

## Slide opener

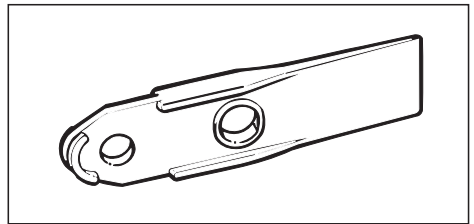

Use the slide opener to remove the light cover.

## Controls

The oven controls consist of the program selector and push buttons.



All temperature and time selections are made by using the "+" or "-" buttons. Advancements can be made slowly, one digit at a time, with short pushes of the button. Rapid advancements can be made by holding the button in.

- oven temperature in 10°F/5°C increments
- core temperature in 2°F/1°C increments
- timer in 1 minute increments

While this light is on, times and temperatures can be entered or changed.

When the indicator light goes out your entry will be temporarily stored.

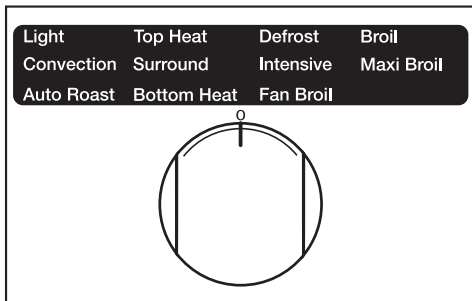

The program selector can be turned either way to a program.

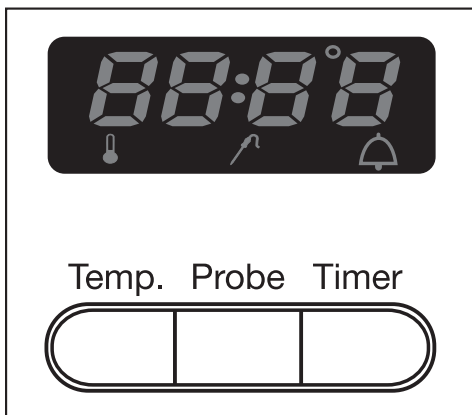

Each push button has a matching symbol in the oven display.

Button	controls:	symbol
Temp.	oven temperature settings	
Probe	core temperature settings	
Timer	timer operations	

# Safety Locks

## Child Safety Lock

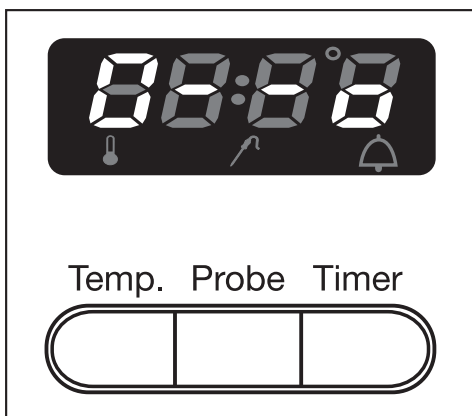

The child safety lock can be activated to prevent children from operating the oven.

### To activate the Child Safety Lock:

- Make sure the program selector is in the "0" (OFF) position.
- Press the "Temp." button until the key symbol appears in the display.

Once this symbol appears, the oven is locked.

### To deactivate the Child Safety Lock:

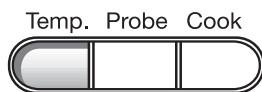

- Press the "Temp." button until the key symbol in the display disappears.

## Automatic door lock in the Self Clean program

After the first minute of the Self Clean program, the door will lock automatically.

The lock releases once the cleaning program has ended and the oven temperature has dropped below 530°F/280°C.

If "Self Clean" is accidentally selected or the program is interrupted the door lock will only release if the program selector is turned to "0" and then to "Light". After 30 seconds the "⚡" symbol will flash, and the door can be opened.

# Before using for the first time

## Heat the oven

New ovens may have a slight odor during the first few uses. To eliminate the odor quickly, the oven should be operated at a high temperature for 2 hours.

Make sure the room is well ventilated during this process.

- Before heating the oven remove all accessories, labels and protective plastic films.
- Use a soft cloth or sponge to wipe out the oven interior using a solution of warm water and a non-abrasive detergent. Dry the interior with a soft cloth.

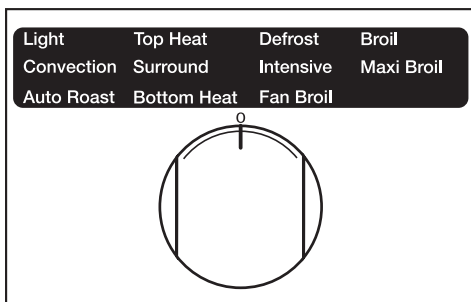

- Turn the program selector to "Convection".

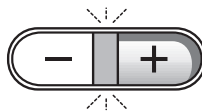

- Set the temperature to 480°F (250°C), using the "+" button while the indicator light between the "+" and "-" buttons is lit.

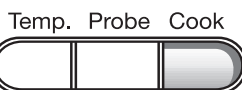

- Set the timer by pressing the "Cook" button.

"0:00" will appear in the display and the "+/-" indicator will light.

- While the light between the "+/-" buttons is lit, enter 2 hours using the "+" button.

The oven will begin to heat as soon as the indicator light between the "+/-" buttons goes out.

# Using the oven

- ① Turn the program selector to the desired program.



The default oven temperature, will appear in the display and the indicator between the "+/-" buttons will light.

The oven will start to heat as soon as the indicator between the "+/-" buttons goes out.

- ② Adjust the default temperature if needed.
- ③ Allow the oven to preheat if necessary.  
The rising oven temperature can be monitored in the display.
- ④ Place food in the oven.
- ⑤ Enter the cooking time.

## At the end of the cooking time:

A tone sounds for 5 seconds and the "H→" symbol flashes.

To turn off the tone and the flashing symbol,

- press the "Cook" button.
- turn the program selector to "0".

## Interrupting cooking / turning off the oven

- Turn the program selector to "0".

The oven will turn off, and all programs will be canceled.

Exceptions:

If the roast probe is inserted in its socket, the "↗" symbol will remain lit.

## Adjusting the default temperature

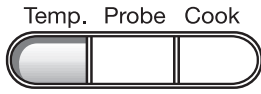

- Press the "Temp." button.

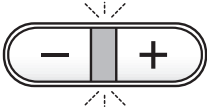

- Using the "+/-" buttons enter the desired temperature.

The default temperature of each program, can be adjusted within the range shown below:

<b>Convection</b>	90-480°F (30-250°C)
<b>Auto Roast</b>	210-440°F (100-230°C)
<b>Top Heat</b>	90-480°F (30-250°C)
<b>Surround</b>	90-510°F (30-280°C)
<b>Bottom Heat</b>	210-480°F (100-250°C)
<b>Defrost</b>	90-120°F (30-50°C)
<b>Intensive</b>	120-480°F (50-250°C)
<b>Fan Broil</b>	120-470°F (50-260°C)
<b>Broil</b>	390-570°F (200-300°C)
<b>Maxi Broil</b>	390-570°F (200-300°C)

# Using the oven

The time display can show the time of day or turn the oven on and off automatically.

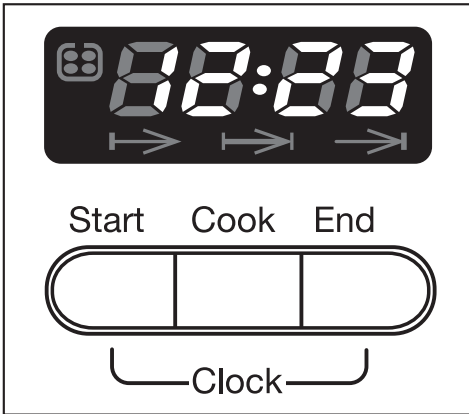

With the push buttons you can control several timer functions.

Button	controls:	symbol
Start	when to <b>start</b> cooking	⏸
Cook	the <b>duration</b> of cooking	⏱
End	when to <b>end</b> cooking	⏹



All data input or adjustments are done with the "+" or "-" button.

Changes to the start, length, end of cooking time or time of day are made in 1 minute increments.

As soon as one of the (Start, Cook, End) buttons is pressed, the **indicator between the "+" and "-" buttons will light** allowing times to be entered or changed.

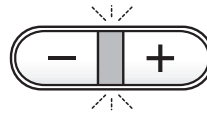

Once the indicator light goes out, any data input or change will be stored.



## Entering the time of day

When the appliance is first connected to the power supply, or after a power failure "12:00" and the symbols "⏪" and "⏩" flash in the display.

To set the time:

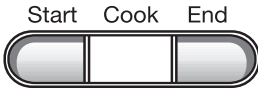

- Press the buttons "Start" and "End" at the same time.

"12:00" will appear in the display and the "+/-" indicator will light.

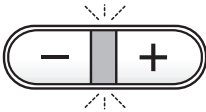

- While the indicator is lit, enter the time in hours and minutes by pressing the "+" or "-" button.

When the "+/-" indicator goes out, the time of day has been set and the display will change in 1 minute increments. The colon will flash.

## To conceal the time of day

The time of day display can be turned off to save energy.

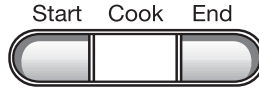

- Simultaneously press the buttons "Start" and "End" twice in succession.

The time of day will be concealed but continues to run unseen.

## To make the time visible

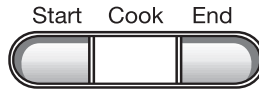

- Simultaneously press "Start" and "End" once.

The time of day cannot be concealed, changed or canceled if the timer has been set.

(To adjust for daylight savings, refer to section "Turning additional features on or off", feature 07).

# Using the oven

---

## Programming the cooking time

With the timer it is possible for the oven to turn off automatically, or be set to come on and turn off at a later time.

When a program is pre-selected, the setting chosen and the symbol "↓" are displayed. The time of day and the symbols for the times entered (↑→, ↑→↓ or →↓) are also shown.

During a process the actual temperature is shown in the oven display.

Shortly before the end of cooking the Energy-Conservation feature is activated and the oven heating turns off automatically.

## At the end of cooking

- a tone sounds for 5 seconds,
- and the "→↓" symbol flashes.

Both the tone and the flashing symbol can be canceled by:

- Pressing the "End" button.  
If the food is not sufficiently cooked, a longer cooking time can be entered.
- Turning the program selector to "0".

If the tone is not canceled it will continue to sound every 5 minutes for an hour as a reminder.

## To program a cooking time to end automatically

- Select the desired program.

The oven will begin to heat.



- Press the "Cook" button.

The heating is turned off, and "0:00" appears in the display.

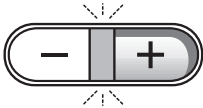

- Using the "+" button enter the cooking time in hours:minutes (up to 23 hours 59 mins).

The cooking process will start as soon as the indicator between the "+/-" buttons goes out.

Cooking will end once the time entered has elapsed.

## To enter a cooking length and a time for the oven to shut off

- Select the desired program.

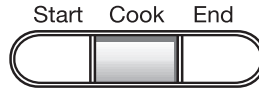

- Press the "Cook" button.

"0:00" appears in the display.

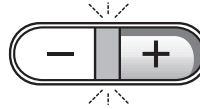

- Using the "+" button enter the cooking time in hours:minutes (up to 23 hours 59 mins).

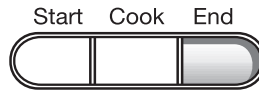

- Press the "End" button.

The time of day and the entered cooking time will appear in the display.

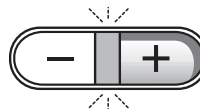

- Using the "+" button enter the actual time you want the oven to stop cooking.

Once the indicator between the "+/-" buttons goes out the timer has been set.

## Using the oven

---

### Enter the start time and the length of cooking

- Select the desired program.
- Press the "Start" button.

"0:00" appears in the display field.

- Use the "+" button to set the actual time for the oven to start.



- Press the "Cook" button to enter the cooking time.

"0:00" appears in the display.

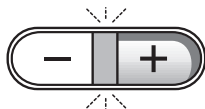

- With the "+" button enter the cooking time in hours:minutes.

If only a start time is programmed, the oven will start heating immediately, except when cooking with the roast probe.

### Checking, changing and canceling times entered

It is possible at any time to review or change the times entered.

- Press the button for the desired time to be viewed.

"Start"

The start time of the cooking process is displayed. This goes out as soon as the process begins.

"Cook"

The display shows the duration of the cooking time, or the time left if the program has started.

"End"

The ending time of the cooking process is displayed.

## To change

- Press the "Start", "Cook" or "End" button.

The indicator between the "+/-" buttons comes on.

- Use the "+/-" buttons to enter the new time.

When the indicator light between the "+/-" buttons goes out, the newly selected time is entered. The time of day will appear in the display.

### Note :

If a button is pressed, where the time was not entered, but calculated automatically by the system, the indicator light between the "+/-" buttons will not light.

This time cannot be changed.

## To cancel an entered time

- To cancel, press the appropriate button and use the "-" button to set the time to "0:00".

If the cooking time is canceled, this automatically cancels the Start / End time, and vice versa. New times must be entered for the oven to begin the program.

## To cancel a program

- Turn the program selector to "0".

During a power failure all programming entered will be deleted.

# Using the oven

## Entering a cooking time

When a cooking time is entered the oven will turn off automatically at the end of the elapsed time.

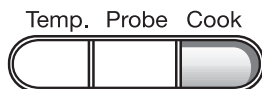

- Press the "Cook" button.

"0:00" will appear in the display and the "+/-" indicator will light.

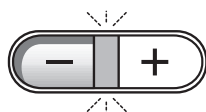

- While the light between the "+/-" buttons is lit, enter the cooking time using the "+" button. Up to 23 hours 59 minutes can be entered.

The cooking process will begin as soon as the indicator light between the "+/-" buttons goes out.

This function is not available when using the roast probe.

## Checking, changing and deleting a cooking time

### To check a cooking time

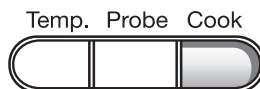

- Press the "Cook" button.

The remaining cooking time will appear in the display.

### To change a cooking time

- Press the "Cook" button.

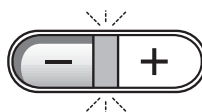

- Use the "+" or "-" buttons to enter the new time.

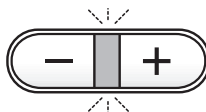

When the indicator between the "+/-" buttons goes out, the new time has been entered.

### To delete a cooking time

- Press the "Cook" button.
- Use the "-" button to set the cooking time to "0:00".

During a power failure, all entries will be canceled.

## Rapid heat

The rapid heat feature activates the heating elements at maximum power to heat the oven quickly. With the "Convection", "Auto Roast" and "Surround" programs, the "Rapid heat" feature will activate automatically if the selected temperature is:

- at least 280°F (140°C) with "Convection" and "Auto Roast"

or

- at least 300°F (150°C) with "Surround".

The rotating "F" ("C") beside the temperature display indicates that "rapid heat" is on.

As soon as the desired temperature has been reached, the additional heating elements used during "rapid heat" will turn off.

## To turn off "rapid heat"

For some dishes it may be desirable to turn off "rapid heat" (cookies, small cakes).

- Select the oven program and temperature.

As soon as the actual temperature appears in the display, "rapid heat" can be turned off.

- Press the "-" button and hold until the "F" ("C") in the display stops rotating.

Once the program selector has been turned to "0", "Rapid heat" will be available for the next use.

# Using the oven

---

## Customizing a temperature setting

The default temperature of a program can be changed if you frequently work with temperatures that differ from the factory settings (except "Defrost").

To change the default temperature:

- Turn the program selector to the program that is to be given a different temperature.

The default temperature will appear in the display.

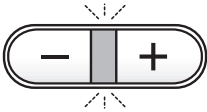

- Use the "+" or "-" buttons to enter the desired temperature.

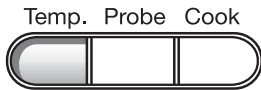

- To store the new temperature, press the "Temp." button until a tone is heard.

The new temperature will appear when the program is selected.

In the event of a power failure, any customized temperatures will be lost and must be entered again.



## Energy-Conservation feature

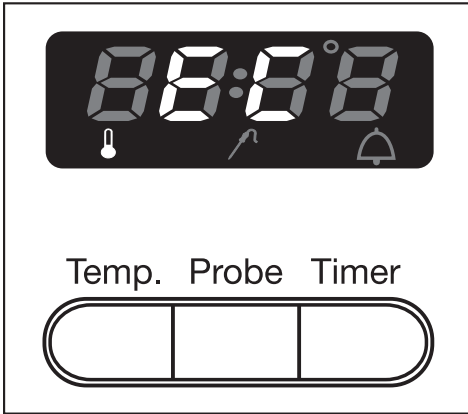

When using the "Timer" button or the roast probe, the residual heat of the oven is automatically used to finish the cooking process and conserve energy.

Shortly before the end of the cooking process, the oven shuts off the heat. The letters "EC" will appear in the display.

The cooling fan will continue to run in "EC", as well as the convection fan if a "fan" function was chosen.

## Oven lighting

The oven will light when the oven door is opened, and during programming. The light will go out when the door is closed, or 15 seconds after a button has been pushed.

The oven lighting can be changed (see "Turning additional features on or off, feature 03").

## Night dimming

Between the hours of 10 p.m. and 6 a.m. (22:00 and 6:00) the lighting in the clock / timer display is dimmed automatically to conserve energy.

## Setting the timer

---

The timer can be used to time an activity separate from the oven.

### To set the timer

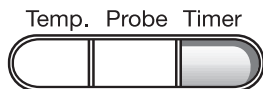

- Press the "Timer" button.
- Enter the desired time in hours and minutes (up to 23 hrs. 59 mins.) with the "+" button.

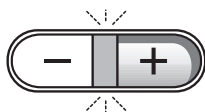

When the "+/-" indicator light goes out, the time set starts counting down in minutes.

If the oven is also being used, the remaining time will only show for a short time. Then the oven or probe core temperature will appear again in the display. The "Δ" symbol will continue to be visible as a reminder that the timer is working.

### At the end of the timed period:

- a tone sounds for 5 seconds.
- the "Δ" symbol will flash for 1 minute.

The tone and the flashing symbol can be canceled by pressing the "Timer" button.

### To cancel the timer

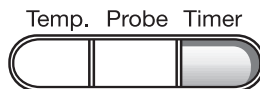

- Press the "Timer" button.

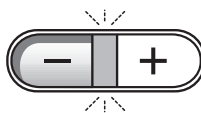

- Use the "-" button to set the timer to "0:00".

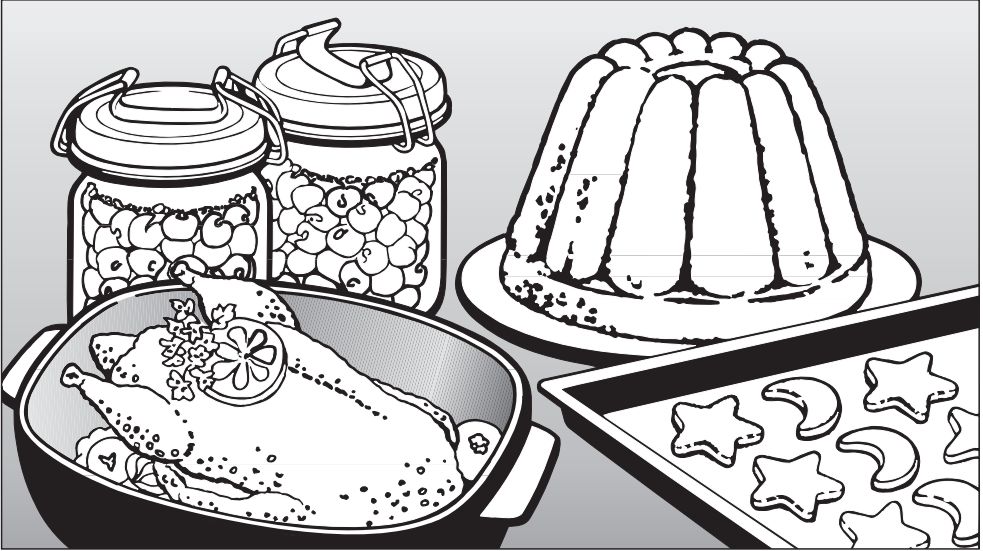

## Guide to the programs

# Baking

---

## Convection

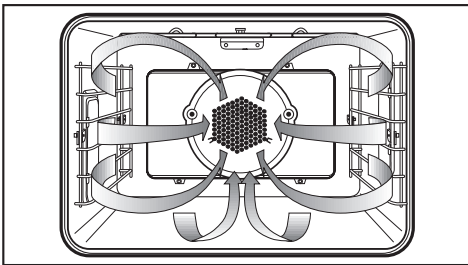

Default temperature . . . . 320°F (160°C)

This program actively circulates heated air throughout the oven cavity for a consistent baking temperature.

Use this program for:

- cookies, cakes,
- soufflés, casseroles, quiche,
- frozen dinners,
- salmon, lobster tails,
- meat loaf, prime rib.

When using Convection, several runner levels can be used at the same time.

The recommended positions are:

1 tray = 1<sup>st</sup> runner from the bottom

2 trays = 1<sup>st</sup> and 3<sup>rd</sup> runners  
from the bottom

3 trays = 1<sup>st</sup>, 3<sup>rd</sup> and 4<sup>th</sup> runners  
from the bottom

As a general rule, the temperature of a recipe not designed for baking in a convection oven should be lowered by 25 °F (15 °C.)

Remember to remove the grease filter from the fan opening when baking pastries. If the filter is not removed, increase the baking time.

## Intensive

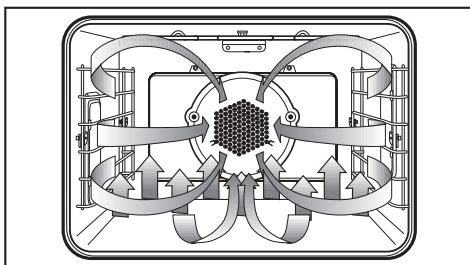

Default temperature . . . . 340°F (170°C)

The "Intensive" program generates heat from the lower heating element. The oven's fan gently circulates the heated air to create a brick oven environment.

Use this program for:

- baked potatoes, french fries,
- pizza, stromboli,
- brisket, pot roast,
- cheesecake, pies.

Use the 1<sup>st</sup> runner from the bottom. Should the bottom of the food burn, try raising the rack to a higher runner.

When using "Intensive", recipe temperatures should be lowered by 25°F (15 °C).

"Intensive" is not recommended for roasting or shallow baking.

Since only the lower heating element is used, bake only on one level. Do not bake on the oven floor.

Remove the grease filter from the fan opening. If the filter is not removed, increase the baking time.

## Surround

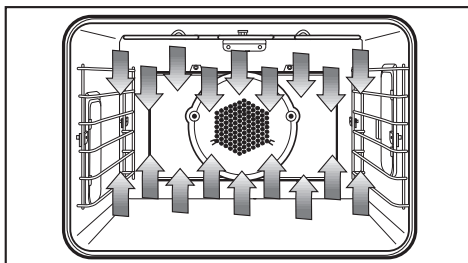

Default temperature . . . . 370°F (190°C)

The "Surround" program is a premium conventional baking mode. The oven heats with both the upper and lower heating elements without the convection fan.

Use this program for:

- angel food cake,
- cream puffs,
- meringue.

The recommended positions are the 1<sup>st</sup> or 2<sup>nd</sup> runners from the bottom.

# Baking

## Top Heat

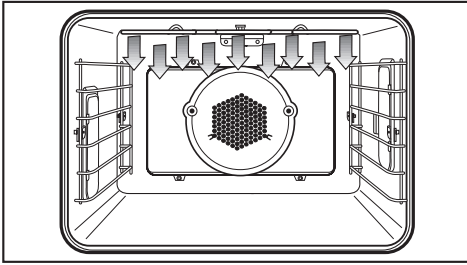

Default temperature . . . . 370°F (190°C)

In the "Top heat" program, food is heated from above.

Use this program for:

- browning meringue,
- melting a cheese topping,
- dense quick bread.

The recommended position is the 4<sup>th</sup> runner from the bottom.

## Bottom Heat

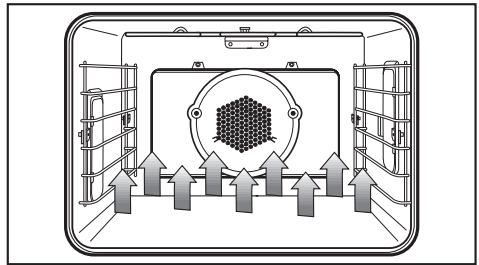

Default temperature . . . . 370°F (190°C)

The "Bottom heat" program works by heating food from below. This is similar to the "bake mode" of a conventional oven.

Use this program for:

- cakes,
- baked apples,
- quick breads,
- spare ribs.

The recommended positions are the 3<sup>rd</sup> or 4<sup>th</sup> runners from the bottom.

## Auto Roast

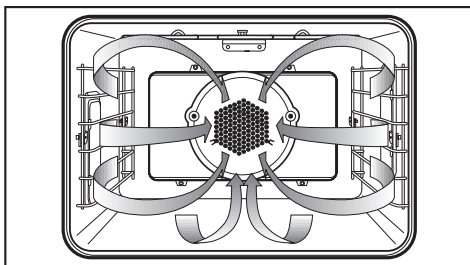

Default temperature . . . . 320°F (160°C)

This premium convection program heats the oven to a high temperature to sear the meat, and retain moisture and tenderness.

Once the oven cavity temperature has exceeded the set temperature, the program returns to the selected temperature.

Use this program for:

- large cuts of meat,
- poultry.

The recommended position is the 3<sup>rd</sup> runner from the bottom.

The oven should not be preheated when using "Auto Roast".

## Surround

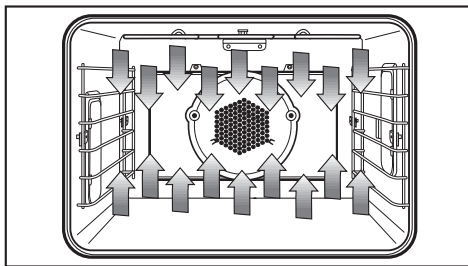

Default temperature . . . . 370°F (190°C)

"Surround" is a conventional roasting program for traditional recipes.

Use this program for:

- pot roast,
- leg of lamb,
- pork loin.

The recommended position is the 2<sup>nd</sup> runner from the bottom.

# Roasting

---

## Roasting tips

- Always install the grease filter in the back of the oven before roasting.
- The larger the cut of meat to be roasted, the lower the temperature that should be used.  
The roasting process will take a little longer, but the meat will be cooked evenly and the outside will become crisp.
- Use the roast probe for accurate cooking temperatures and best results.

## Roasting in a covered pot

When roasting in a covered pot, increase the recipe temperature by 70°F (20°C).

Season the meat and place in the pot. Add some butter, margarine or a little oil. Add about ½ cup of water when roasting a large piece of meat or roasting poultry with a high fat content.

## Roasting on the rack

Add a little oil to very lean meat or place a few strips of bacon on top to help retain moisture. Place a little water in the roasting pan on the rack below the meat to catch drippings.

## Roasting poultry

For crispy skin, baste the poultry ten minutes before the end of cooking with salt water.



## Using the roast probe

The roast probe reliably monitors the roasting process. The tip of the probe continuously measures the core temperature of the meat or poultry.

When the selected core temperature is reached, the oven automatically shuts off.

The roast probe can be used with the following programs:

- Auto Roast
- Convection
- Surround
- Fan Broil

### Using the roast probe:

- Prepare the meat as usual, and put it into the oven (in a pot or on the rack).

Roasting bags may be used, but only when left open at the ends. Insert the probe into the meat or poultry through the opened end of the bag.

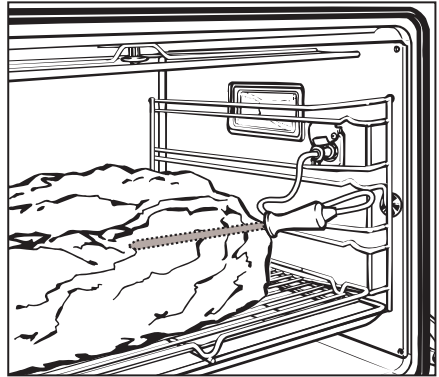

- Insert the probe into the middle of the meat. Make sure that the probe does not touch any bones and is not located in a fatty area. Improper insertion of the probe could shut the oven off too early.

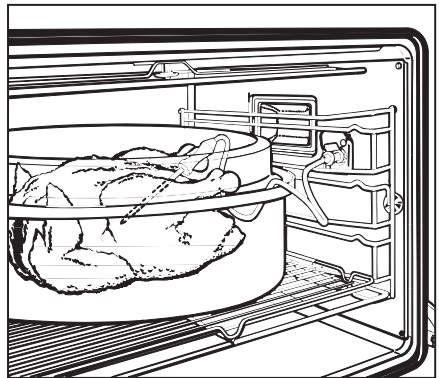

- When roasting poultry, insert the probe into the thickest part of the bird, between the thigh and body.

## Using the roast probe

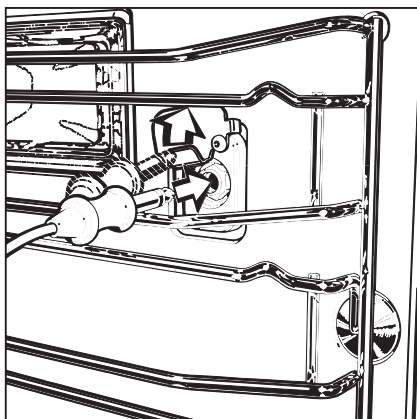

- Insert the short end of the roast probe into the socket on the right side of the oven until it clicks into place.
- Turn the program selector to the desired roasting program.

The **default oven temperature** will show in the oven display, and the indicator between the "+/-" buttons will light.

This temperature can be changed by using the "+/-" button.

A **core temperature** of 140°F (60°C) will appear in the oven display, and the indicator between the "+/-" buttons will light.

- Adjust the core temperature if necessary.

### To adjust the core temperature:

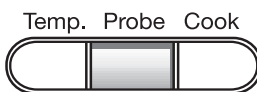

- Press the "Probe" button.

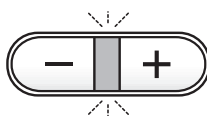

- Change the temperature using the "+" or "-" button. Range of 67°F to 209°F (20°C to 99°C).

The oven will start heating when the light between the "+/-" buttons goes out.

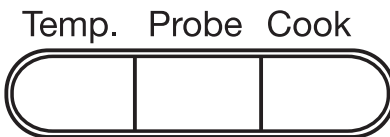

The **actual core temperature** will appear in the oven display. The lowest temperature that can be displayed is 67°F (20°C). This will not change until the temperature is greater than 67°F (20°C).

# Using the roast probe

## Time remaining display



Once the oven has monitored the cooking process, it will calculate and display the remaining cooking time. The core temperature will no longer be displayed.

The time remaining that is first displayed is an estimate. As cooking continues, the time will be revised, and an increasingly accurate estimate will be shown.

If the selected core temperature or oven program is changed, the time remaining will be canceled and the core temperature will reappear.

Shortly before the end of the cooking time, the Energy Conservation feature will activate. If the "Temp." button is pressed, "EC" will appear in the display.

If the oven temperature is changed or the core temperature increased, the oven heating will turn on again.

## End of roasting

When the selected core temperature has been reached:

- a tone will sound for 5 seconds,
- the "↗" (roast probe) symbol will flash.

The tone can be canceled by:

- pressing the "Probe" button.
- turning the program selector to "0".

### Note:



When finished roasting, cover the meat with aluminum foil and allow to stand for 10 minutes. During this time, the core temperature will rise 10°F (5°C).

If the temperature probe is left in the food at the end of roasting, the oven display will show the core temperature first increasing and then decreasing.

# Roasting Recommendations

	Runner level	Auto Roast <sup>1</sup>		Surround		Core Temp. °F (°C) <sup>3</sup>
		Temp. °F (°C) <sup>2</sup>	Time (min)	Temp. °F (°C) <sup>2</sup>	Time (min)	
Roast beef 2 lbs (1 kg)	1	360-390 (180-200)	100-120	420-470 (220-240)	100-120	170-190 (80-85)
Steak <sup>4</sup> 2 lbs (1 kg)	1 <sup>5</sup>	380-410 (190-210)	35-45	420-470 (240-260)	35-45	105-150 <sup>6</sup> (40-65)
Venison/game 2 lbs (1 kg)	1	360-390 (180-200)	90-120	420-470 (220-240)	90-120	160-180 (75-80)
Roast pork, shoulder 2 lbs (1 kg)	1	340-380 (170-190)	100-120	410-450 (210-230)	100-120	170-190 (80-85)
Pork chop 2 lbs (1 kg)	1	340-380 (170-190)	60-80	390-430 (200-220)	60-80	150-170 (70-75)
Ribs 2 lbs (1 kg)	1	340-380 (170-190)	60-70	410-450 (210-230)	60-70	160-180 (75-80)
Minced meat 2 lbs (1 kg)	1	340-380 (170-190)	50-60	390-430 (210-230)	50-60	160-180 (75-80)
Roast veal 2 lbs (1 kg)	1	340-380 (170-190)	100-120	410-450 (210-230)	100-120	160-170 (70-75)
Lamb shoulder 3 lbs (1.5 kg)	1	340-380 (170-190)	90-120	410-450 (210-230)	90-120	170-190 (80-85)
Poultry 2 lbs (1 kg)	1 <sup>5</sup>	340-380 (170-190)	50-60	390-430 (200-220)	50-60	190 (85)
Poultry 4 1/2 lbs (2 kg)	1	340-380 (170-190)	90-110	390-430 (200-220)	90-110	190 (85)
Poultry, stuffed 4 1/2 lbs (2 kg)	1	340-380 (170-190)	120-150	390-430 (200-220)	120-150	190 (85)
Poultry 9 lbs (4 kg)	1	320-360 (160-180)	150-180	380-410 (190-210)	150-180	190 (85)
Whole fish 3 lbs (1.5 kg)	1 <sup>5</sup>	320-360 (160-180)	35-55	390-430 (200-220)	35-55	160-180 (75-80)

Unless otherwise stated, times given are for an oven which has not been preheated.

- 1 Insert the grease filter when using "Auto Roast"
- 2 When roasting in a covered pot   
When roasting on the rack 
- 3 When roasting with the probe 
- 4 Preheat the oven
- 5 Use the second runner from the bottom when cooking with "Surround"
- 6 Rare: 140°F (60°C); Medium: 160°F (70°C); Well done: 170°F (82°C)

The information in this chart is intended as a guide only.

## Broil

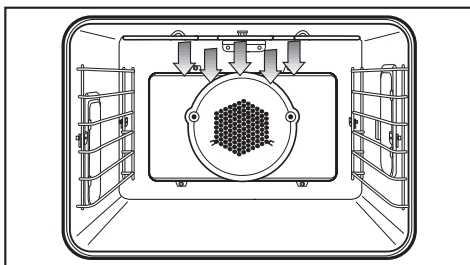

Default temperature . . . . 460°F (240°C)

Only the inner part of the upper heating element is used for a smaller area of intense heat from above. This function is excellent for broiling or searing small quantities.

Use this program for:

- chops,
- small or thin pieces of meat,
- browning small dishes.

The recommended position is the 4<sup>th</sup> runner from the bottom.

## Maxi Broil

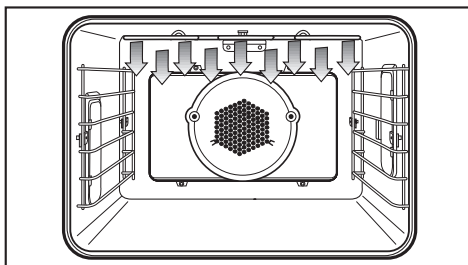

Default temperature . . . . 460°F (240°C)

The entire upper heating element is used for intense heating from above. This program gives excellent browning and searing results.

Use this program for:

- london broil,
- chops,
- large quantities of meat,
- browning large dishes.

The recommended position is the 4<sup>th</sup> runner from the bottom.

# Broiling

## Fan Broil

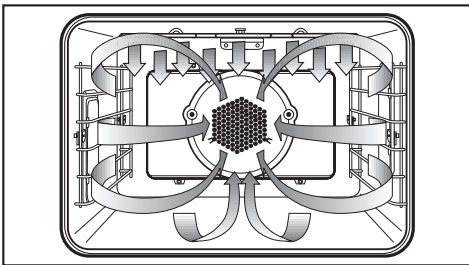

Default temperature . . . . 390°F (200°C)

Hot air from the upper heating element is distributed over the food by the fan. This enables a lower temperature than conventional broiling to be used.

Use this program for:

- steak,
- lamb.

The recommended position is the 4<sup>th</sup> runner from the bottom.

Always insert the grease filter over the convection fan in the back of the oven when using "Fan Broil".

The roast probe can be used in this function to monitor the meat's core temperature. Refer to "Using the roast probe" for more information.

## Broiling on the rack

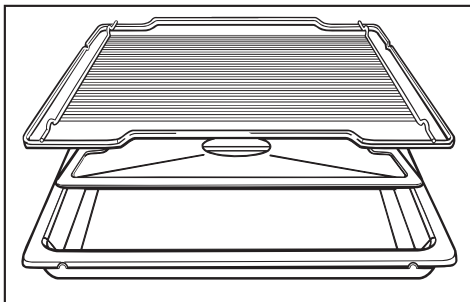

- Assemble the broil pan, anti-splash tray and rack as shown.
- Place the food on the rack  
thin cuts = runner level 3 or 4  
thicker cuts = runner level 1 or 2
- Select a broiling program.

## Broiling on the rotisserie

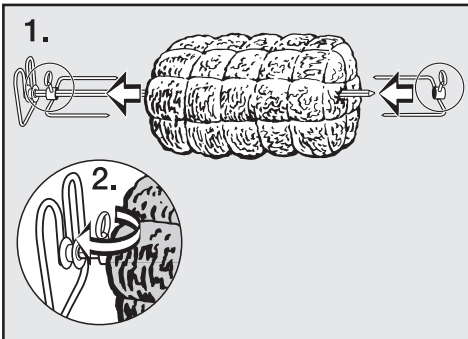

- Secure meat or poultry on the skewers.  
(Poultry legs should be tied together to prevent them from catching on the heating element.)

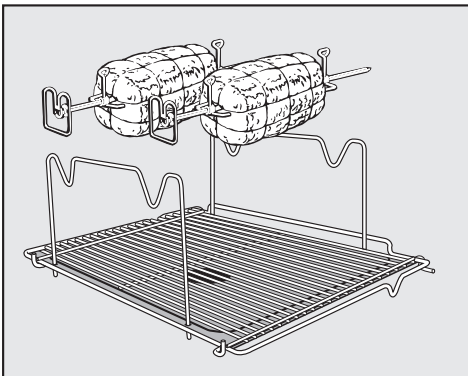

- Assemble the rotisserie as shown.
- Put the rotisserie in the oven, using the lowest level runner.

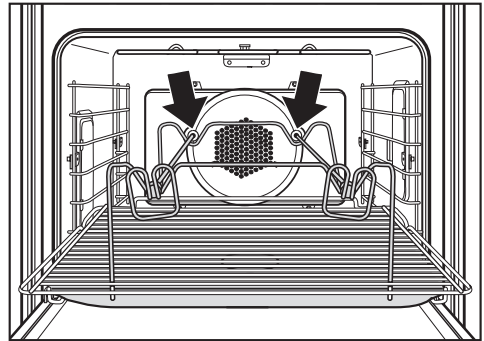

- Insert the spits into the grill motors at the back of the oven.
- Select a broiling program.
- When the oven door is closed, the spits will rotate.

The roast probe cannot be used at the same time as the rotisserie. The cable could wind around the rotisserie and be damaged.

# Broiling

---

## Broiling tips

- To broil thicker pieces of food gradually, sear the meat at a high temperature, then continue broiling at a lower temperature so the food cooks through to the center.
- To ensure even cooking, it is best to broil foods of a similar thickness at the same time. Most items should be turned halfway through broiling.
- To determine how far through a thick piece of meat has been cooked, press down on its surface with a spoon.

If the surface presses down easily and with little resistance to the spoon, it is "rare".

If there is some resistance, it is "medium".

If there is great resistance, it is "well done".



# Broiling chart

Pre-heat for 5 minutes before broiling.

Food to be broiled	Runner from bottom	Broil / Maxi Broil		Fan Broil 1)	
		Temperature in °F/°C	Time (in min.) <sup>2)</sup>	Temperature in °F/°C	Time (in min.) <sup>2)</sup>
<b>Thin to medium size</b>					
Beef steaks	3 or 4	520/275	10-16	430/220	10-16
Kabobs	3 or 4	520/275	12-16	430/220	15-20
Meat cutlet	3 or 4	520/275	12-18	430/220	18-20
Liver	3 or 4	520/275	8-12	430/220	10-14
Burgers	3 or 4	520/275	14-20	430/220	16-20
Sausage	3 or 4	520/275	6-10	430/220	8-12
Fish fillet	4	520/275	12-16	430/220	12-16
Trout / Mackerel	4	520/275	16-20	430/220	20-25
Toast	3 or 4	520/275	2-4	430/220	3-5
Open faced sandwich	4	520/275	4-6	430/220	4-6
Tomatoes	4	520/275	6-8	430/220	6-8
Peach / banana halves	4	520/275	7-10	430/220	7-10
<b>Thick or large size</b>					
Chicken pieces 2 lbs (1 kg) <sup>3)</sup>	1 or 2	460/240	50-60	390/200	50-60
Chicken pieces 2 lbs (1 kg) <sup>4)</sup>	1	460/240	50-60	-	-
Rolled pork 2 lbs (1 kg) <sup>3)</sup>	1	460/240	70-80	390/200	70-80
Rolled pork 2 lbs (1 kg) <sup>4)</sup>	1	460/240	70-80	-	-
Kabobs and mixed items	1	460/240	30-40	390/200	100-120

- 1) Insert the grease filter when using "Fan Broil".
- 2) Turn food over half way through broiling.
- 3) Broiling on the spit
- 4) Broiling on the rack

**All times given are approximate and will vary according to personal taste.**

# Defrost

---

## Defrost

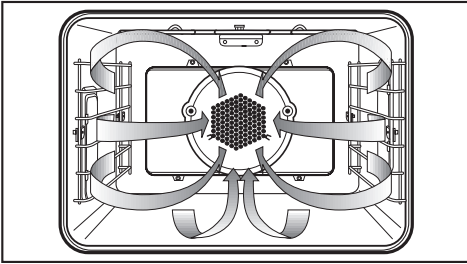

No default temperature

This program allows you to defrost food at a constant temperature. Defrosting should be at room temperature, i.e. without selecting an oven temperature. However, a temperature of up to 120°F (50°C) can be selected.

Defrosting times depend on the type and weight of the food, and at what temperature it was deep-frozen.

## Defrosting tips

- Remove the frozen food from the packaging and place in the roasting pan or into an appropriate dish.
- Meat and poultry should be fully thawed before cooking. Do not use the defrosting liquids.
- Fish does not need to be fully defrosted before cooking. Defrost so that the surface is soft enough to absorb herbs and seasoning.
- Cook all food immediately after defrosting.

Before cleaning or servicing the oven, disconnect it from the power supply by either shutting off the power main or manually "tripping" the circuit breaker.

Never use abrasive cleaners, scouring pads, steel wool or caustic (oven) cleaners on any part of the oven. They **will** damage the surfaces.

## Appliance front

The front of the appliance and the control area can be cleaned with a sponge and a solution of warm water and non-abrasive liquid detergent. Dry with a soft cloth.

Glass surfaces can be cleaned with a glass cleaner.

## Stainless steel

Stainless steel surfaces can be cleaned using a non-abrasive stainless steel cleaner.

To help prevent resoiling, a conditioner for stainless steel can also be used. Apply sparingly with even pressure.

## Stainless steel colored control

Clean the buttons and knobs with a damp sponge and a solution of warm water and soap.

These controls may become discolored or damaged if not cleaned regularly.

## Accessories

Remove all accessories as well as the runners from the oven before starting the Self Clean program. The high temperatures needed for this program will damage the accessories and cause irreparable damage.

## Roast probe

Wipe with soapy water and a non-abrasive damp cloth. Rinse under running water.

Do not submerge the roast probe into water or clean in the dishwasher.

## Grease filter

Clean with liquid dish soap and hot water, or in the dishwasher.

Depending on the detergent, cleaning the grease filter in a dishwasher may cause permanent discoloration of the filter surface. Performance of the filter will not be affected by this discoloration.

## Rotisserie

Wash and dry after each use.

Remove stubborn residues with a stainless steel cleaner.

# Cleaning and care

---

## PerfectClean

Allow the oven and any accessories to cool down before cleaning.  
Danger of burns!

Do not use abrasive cleaning agents, cleansers for ceramic cooking surfaces, metal scourers or oven cleaners on surfaces with PerfectClean enamel.

Clean as soon as possible after each use with a soft sponge and a solution of hot water and liquid dish soap.

Stubborn baked on grease may need to be soaked first to loosen deposits. A scraper suitable for glass surfaces or a plastic scouring pad can be used to remove remaining residues.

Soiling such as spilled juices and cake mixtures are best removed while the oven or tray is still warm.

Spilled fruit juices may permanently discolor surfaces. This discoloration is permanent but will not affect the efficiency of the enamel.

Items with PerfectClean enamel should not need to be cleaned in a dishwasher but can be if desired, hand cleaning should be sufficient.

After cleaning rinse thoroughly with clean water. The water must run off the surface easily. Any residual cleaning agents will hinder this effect.

## Oven interior

The oven interior is coated with an extremely smooth dark pyrolytic enamel which facilitates cleaning.

Because of its non-stick properties most debris can be easily removed with a damp cloth. This should be done after each use.

If the oven is not cleaned regularly, debris may become extremely difficult to remove even with the Self Clean program.

Never use hard brushes, hard sponges, wire wool pads, knives or any other scourer. These may damage the enamel.

## Self Clean program

During Self Clean the oven is heated to very high temperatures to remove any residual soiling.

One minute after the Self Clean program starts, the oven door will automatically lock. The lock will only release when the program has completed and the oven temperature has fallen below 530°F/280°C.

The length of the Self Clean program will depend on the level of soiling in the oven.

Remove large pieces of debris and any puddles of grease from the oven interior before starting the Self Clean program.

Remove all accessories including the runners from the oven before starting the cleaning program.

Do not touch the oven door during the Self Clean program. The door may become very hot.

Keep children away from the hot oven.

- Turn the program selector to "Self Clean".

"PYRO" will light, and the "🔥" symbol will flash in the oven display.

- Press the "Temp." button.

As soon as the "Temp." button is pressed,

- the "🔥" symbol lights up,
- the oven door will lock after 1 minute,
- the cleaning process begins,
- the catalytic converter turns on.

## Cleaning and care

---

If the oven interior is extremely soiled, the Self Clean program will automatically shut off. Remove large pieces of debris and restart the Self Clean program.

A tone will sound and the "🔥" symbol will flash when the Self Clean program has ended.

Once the oven has cooled remove the pyrolytic ash.

Most debris can be removed with a damp cloth.

Sometimes a film can build up on the oven door. This can be removed with a shielded scraper blade or a non-abrasive sponge and a mild solution of warm water and liquid soap.

The Self Clean program can be set to start at a later time like the other programs, see "Using the oven - Programming the cooking time".

The Self Clean program will interrupt,

- if the program selector is turned to the "0" position,
- if another program is selected during the cleaning process,
- in the event of a power failure.

The oven door will remain locked if the program is interrupted.

The door will only open again when the oven temperature has fallen below 530°F/280°C and the program selector has been turned to the "0" position and then to "Light". The "🔥" symbol will light up in the display.

After 30 seconds, the "🔥" symbol will flash and the door can be opened.

If the heating phase of the Self Clean program interrupts independently, the error message "F15" will appear in the display.

The door will only open again when the oven temperature has fallen below 530°F/280 °C and the program selector has been turned to the "0" position and then to "Light".

After approx. 60 seconds the error message will go out "PYRO" and the "🔥" symbol will light up in the display.

After 30 seconds, the "🔥" symbol will flash and the oven door can be opened.

## Cleaning the oven cavity by hand

 Danger of burns! Allow the oven to cool before cleaning.

### To make cleaning easier

- remove the oven door,
  - remove the runners,
  - lower the upper heating element,
  - remove the safety guard.
- Clean the oven surfaces with a solution of hot water and liquid dish soap, and a sponge or soft nylon brush.

Do not use abrasive cleaning agents, hard brushes, metal scouring pads, steel wool, knives or other abrasive materials.

Do not use oven sprays on any part of this oven.

- Dry surfaces before reassembly.

Please note: The oven door is quite heavy. It should be gripped firmly at the sides when being removed or refitted.

## Removing the oven door

- Open the door fully.

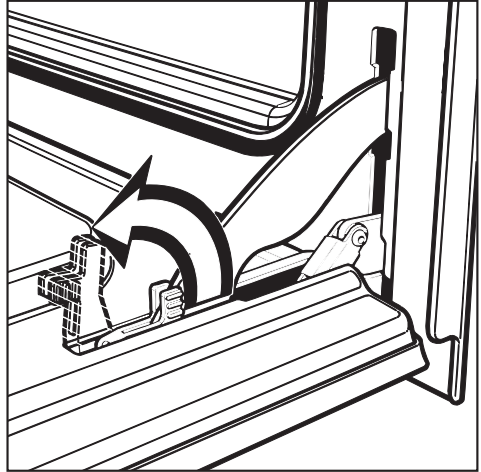

- Flip up the locking clamps on each door hinge.



- Grip the sides of the door and lift until the hinges disengage. Remove the door.

## Cleaning and care

### Removing the runners

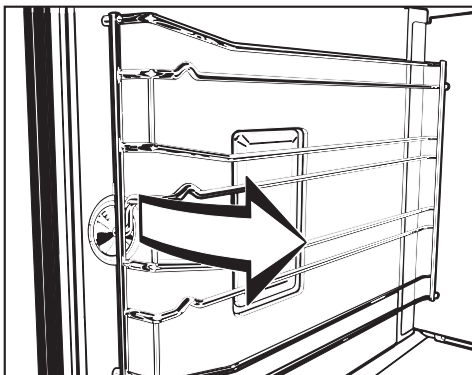

- Pull on the fastener to release the runner.

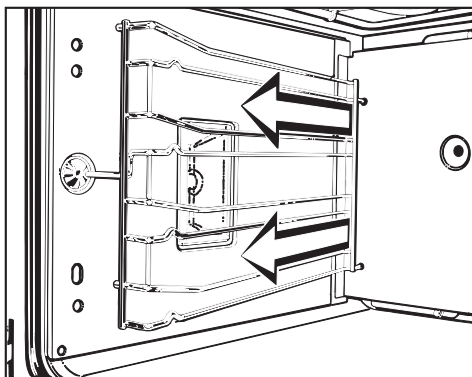

- Pull the runner out from the rear of the oven.

### Lowering the upper heating element

- Remove the runners.

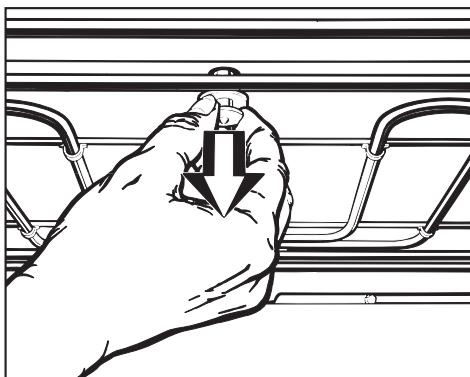

- Pull and turn the fastener on the grill element to release it.
- **Gently** lower the grill element.



## Refitting the oven door

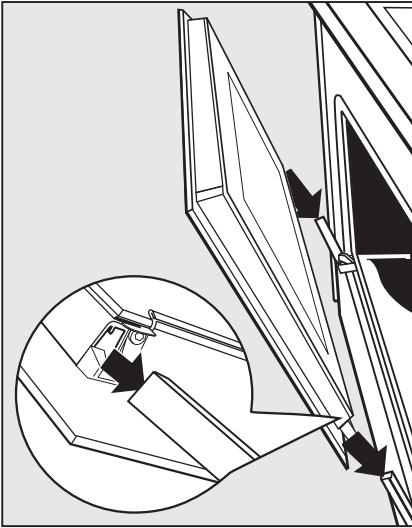

- Hold the door as shown above and carefully put the locked hinges into the guide holes until they engage. Open the door fully.
- Still supporting the door, flip the locking clamps down.

Check that the locking clamps are flipped down when the door is reinstalled after cleaning. Otherwise, the hinges may work loose from the guide holes and damage the door.

## Changing the light bulb

- Turn off the electrical supply to the oven at the circuit breaker.
- Take the runners out of the oven.
- Remove the catalytic liners, if present.

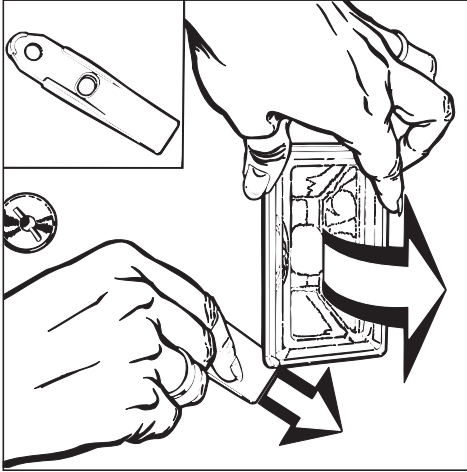

- Remove the lamp cover.  
Use the supplied slide opener to pry the lamp out of the side panel.
- Replace the halogen bulb.  
Only use a 12 V, 10 W, heat resistant up to 572°F/300°C, Osram, type w818 bulb.  
**DO NOT TOUCH** the new bulb with your fingers; touching the bulb will reduce its life. Follow the instructions of the bulb manufacturer.

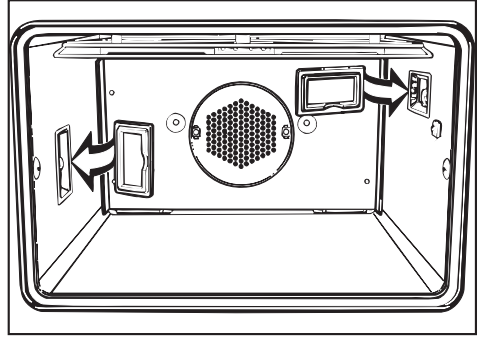

- Press the lamp back into the sidewall of the oven and reinsert the cover.

Reassemble the oven in the reverse order, making sure that all the parts are in place.

# Turning additional features on or off

## To turn an additional feature on or off:

- Turn the program selector to "0".
- Open the oven door fully.
- Turn the program selector to "Light".
- Press the "Temp." button.

"01:0" or the most recently changed feature will appear in the oven display.

- Use the "+/-" buttons to select the additional feature to be changed, (see chart).
- Press the "Timer" button to turn the feature on or off.

The following appears after the colon:

- **1** when the feature is **on**,
- **0** when the feature is **off**.

- Turn the program selector to the "0" position to store the change into memory.

You may change as many additional features as you wish, as long as the program selector has not been turned to the "0" position.

<b>The additional feature is</b> (* marks the factory setting)	
<b>01:0*</b> The program and temperature can be adjusted at any time.	<b>01:1</b> Once the program and temperature have been selected the oven can no longer be adjusted, except to lower the target temperature. Changes can only be made if the program selector is turned back to the "Light" or "0" position.
<b>02:0*</b> no function.	<b>02:0</b> no function.
<b>03:0*</b> The oven lights when selecting a program.	<b>03:1</b> The oven lights when the door is opened.
<b>04:0*</b> The temperature is displayed in °C. The clock/timer has a 24-hour display.	<b>04:1</b> The temperature is displayed in °F. The clock/timer has a 12-hour display.
<b>05:0*</b> The oven light turns off 15 seconds after program selection. The light can be turned back on for 15 seconds by pressing any button.	<b>05:1</b> The oven lights continuously when the oven is in use.
<b>06:0*</b> Rapid heat is on during "Convection", "Auto Roast" and "Surround".	<b>06:1</b> Rapid heat is turned off.
<b>07:0*</b> The time of day entered appears in the display.	<b>07:1</b> The time advances by 1 hour for daylight savings time.
<b>08:0*</b> The time of day entered appears in the display.	<b>08:1</b> While pressing the "Timer" button, the time can be set back by 1hr up to 4 hrs.
<b>09:0*</b> A tone sounds at the end of cooking.	<b>09:1</b> No tone signal at the end of cooking.

## Frequently asked questions

---

Installation work and repairs should only be performed by a qualified technician in accordance with all applicable codes and standards. Repairs and other work by unqualified persons could be dangerous and may void the warranty.

### What if the oven does not heat?

Possible fault	Fix
A program was not selected.	Select a program.
The Child Safety Lock is activated.	Deactivate the Child Safety Lock.
The circuit breaker has tripped.	Check the breaker.
The door is not fully closed.	Close the door firmly.

### What if the oven heats but the light does not illuminate?

Possible fault	Fix
The halogen bulbs are bad.	See "Changing the light bulb".

### What if no noise is heard when the oven door is opened during operation?

This is normal.

If the door is opened during operation, a safety switch causes the oven heaters and the convection fan to turn off.

### What if a noise is heard after baking, roasting or broiling?

This is normal.

The cooling fan will continue to run for a short time. When the internal temperature has fallen sufficiently, the fan will turn off automatically.

### What if cakes and cookies are not cooked enough?

Possible fault	Fix
The grease filter was not removed.	If the grease filter is not removed, increase baking by 10 to 15 minutes

### What if uneven browning occurs?

Possible fault	Fix
Oven not preheated.	Allow the oven to preheat.
Oven temperature too high.	Lower the oven temperature.
Grease filter was not removed.	Remove the grease filter next time.
Shiny or thin pans were used.	Use dark, matte finish pans.

## Frequently asked questions

### What if "F" and a number appear in the oven display?

"F3": The roast probe is faulty.	Remove the probe from its socket and the code will disappear.
"F6": The oven has automatically shut off.	This is a safety feature to protect the oven if it has been operated for too long. The oven can be reset by turning the program selector to "0" and then restarting the program.
"F7" The cooling fan has stopped turning.	If "F7", "F8", "F9" or any other unexplained fault codes are displayed, please call Technical Service.
"F8" The convection fan has stopped.	
"F9" The maximum temperature of the oven has been exceeded, and the oven has shut off. As soon as the temperature has fallen to an acceptable level, the fault code will disappear. The oven will turn itself on again.	
"F13": The door lock for the Self Clean program does not work.	Turn the program selector to the "0" position and then to "Light". After 60 seconds the error message will go out and "PYRO" and the symbol "🔥" will light up in the display. After 30 seconds the symbol "🔥" will flash. Turn the program selector to "0". The oven is ready to operate again. If you still cannot operate the oven or if this error message occurs again contact Technical Service.
"F14": The door lock for the Self Clean program does not open.	If an attempt was made to open the door before the "🔥" symbol started flashing to indicate the end of the cleaning process push the door shut and wait until the "🔥" symbol starts flashing in the display. This releases the lock and the oven door can now be opened. If "F14" still appears in the display there could be a technical fault requiring a service call. Contact Technical Service.

## Frequently asked questions

---

### What if "F" and a number appear in the oven display?

"F15": The Self Clean program was interrupted during the heating phase.

Turn the program selector to "0" and then to "Light". After 60 seconds the error message will go out, "PYRO" and the symbol "🔥" will light up in the display. After another 30 seconds the symbol "🔥" will flash. Turn the program selector to "0". The oven is ready to use.  
If you still cannot operate the oven or if this error message occurs again call Technical Service.

"F17": A temperature sensor is defective.

The oven can still be used but, the catalytic converter will not work properly and the Self Clean program cannot be selected.  
If the temperature sensor fails during the cleaning program the oven door cannot be opened until the internal oven temperature has dropped to below 530°F (280°C) and the "🔥" symbol flashes in the display.

### What if the timer display is dark when the oven is first turned on?

This is normal. If the time display has been turned off, the display will remain dark. If the "Start" and "End" buttons are pressed simultaneously, "12:00" should appear in the display.

### What if the time of day cannot be entered after a power failure?

Check whether the program selector is set to "0". The time of day can only be entered when the program selector is set to "0".

In the event of a fault which you cannot easily fix yourself, please contact the Miele Technical Service Department

 1-800-999-1360  
techserv@mieleusa.com

 1-800-565-6435  
service@miele.ca

When contacting Technical Service please quote the serial number and model of your oven. This information is visible on the silver data plate along the right side of the oven.

## Optional accessories

---

The following accessories are available for purchase from your Miele Dealer or Miele.

### Handle

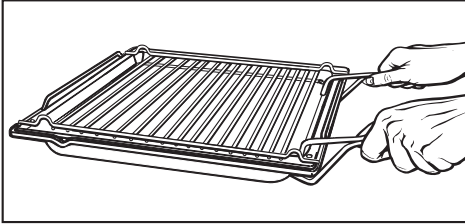

The handles are used to take the baking trays or the roasting pan in and out of the oven.

Part # 03 985 271

### Pizza pan

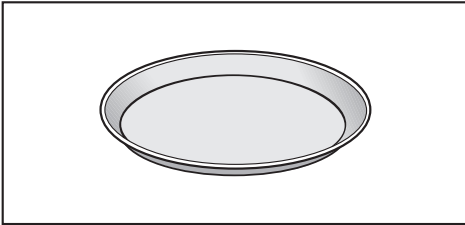

This circular pan is suitable for cooking fresh or frozen pizzas, flat cakes, tarts, and baked desserts.

Part # 05 182 760

### Pizza stone

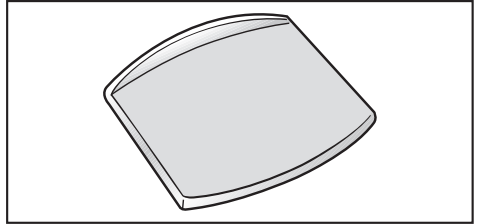

The pizza stone is ideal for baking dishes with a crisp bottom like pizza and bread.

Part # 22 996 071

### Gourmet Casserole

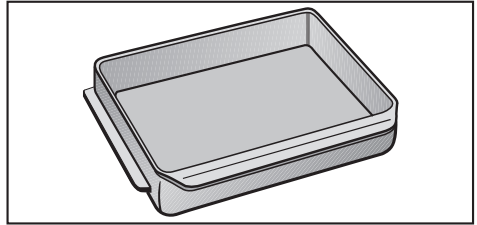

The gourmet casserole has a special non-stick coating. A lid is also available separately.

Small dish part # 22 996 078

Large dish part # 22 996 077



### Catalytic converter

A catalytic converter can be built into the cooling system to filter fat particles and reduce food odors.

### Catalytic liners

The catalytic liners can be replaced. When ordering please state the model number of your oven.

### Poultry clamp and Kabob griller

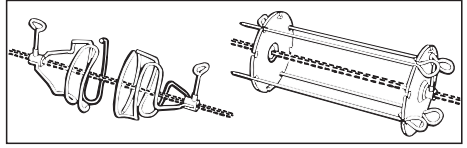

The poultry clamp is ideal for roasting small birds on the rotisserie. The spring like clamps keep wings and legs close to the body to prevent uneven cooking. Part # 01 104 460

The kabob griller allows you to cook 4 skewers of kebabs evenly on the rotisserie. Part # 01 009 230



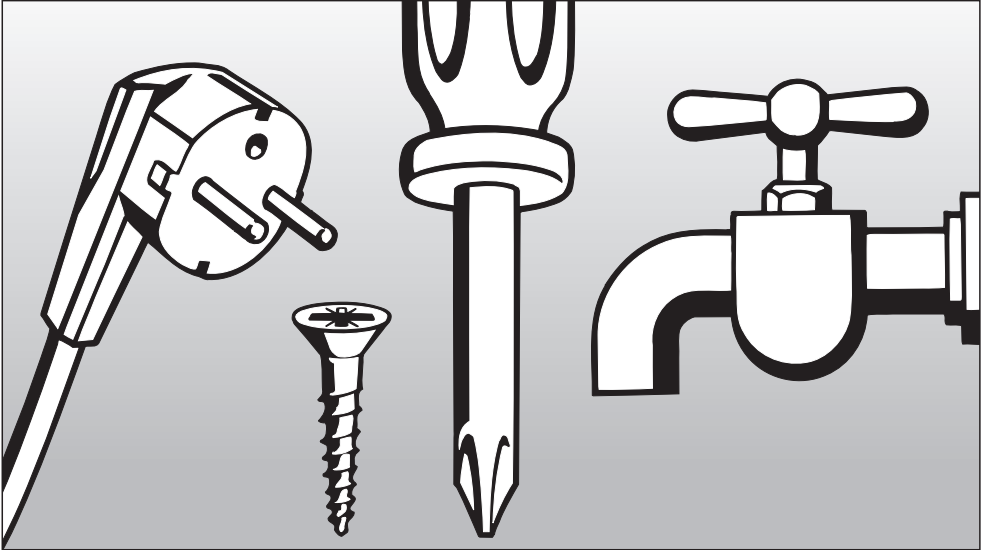

## Installation Instructions

# Caring for the environment

---

## **Disposal of the packing materials**

The cardboard box and packing materials protect the appliance during shipping. They have been designed to be biodegradable and recyclable.

Ensure that any plastic wrappings, bags, etc. are disposed of safely and kept out of the reach of children.  
Danger of suffocation!

## **Disposal of an old appliance**

Old appliances may contain materials that can be recycled. Please contact your local recycling authority about the possibility of recycling these materials.

Ensure the appliance presents no danger to children while being stored for disposal. Before discarding an old appliance, unplug it from the outlet and cut off its power cord. Remove any doors to prevent trapping hazards.

Installation work and repairs should only be performed by a qualified technician in accordance with all applicable codes and standards. Repairs and other work by unqualified persons could be dangerous and the manufacturer will not be held responsible.

Before connecting the appliance to the power supply make sure that the voltage and frequency listed on the data plate correspond with the household electrical supply. This data must correspond to prevent machine damage. Consult a qualified electrician if in doubt.

**CAUTION:** Before servicing, disconnect the power supply by either removing the fuse, unplugging the unit or manually "tripping" the circuit breaker.

**Installer:**  
**Please leave these instructions with the consumer.**

## Power supply

The oven is equipped with a 6 ft./1.8 m flexible power cord consisting of 4 wires ready for connection to a dedicated 3 pole, 4 wire grounding power supply:

– 120/240 V, 60 Hz, 20 A

or

– 120/208 V, 60 Hz, 20 A

Black wire: connect to L1 (hot), 20 A

Red wire: connect to L2 (hot), 20 A

White wire: connect to N (neutral)

Green wire: connect to GND (ground)

A dedicated line and junction box should be used to connect the oven to a 20 A circuit.

Connection details are also given on the diagram located on the top of the oven.

# Installing the oven

The oven must be installed into cabinetry before use.

Do not insulate the cabinet. This will prevent proper ventilation.

If the oven is to be installed under a counter top, a sealing strip must replace the stainless steel rail above the control panel. The sealing strip offers additional protection from any liquids that might spill down from the counter top.

The strip can be purchased from Miele.

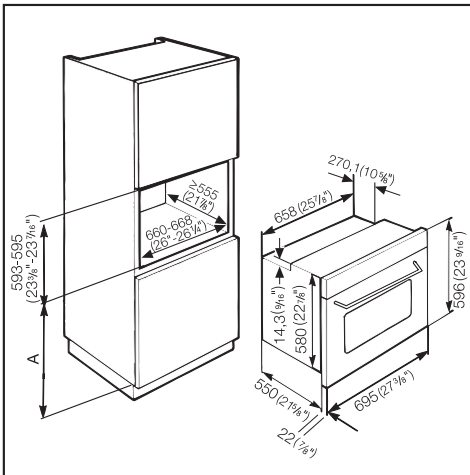

- Connect the oven to the electrical supply.

The oven must be supported from underneath.

- Place the oven into the cabinet as far as the oven trim and align.

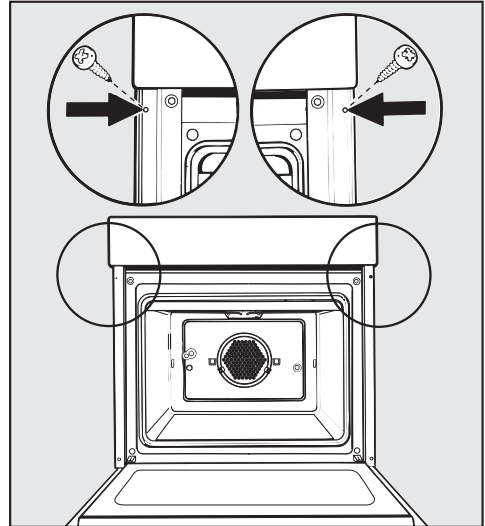

- Open the oven door and locate the two mounting screw holes in the oven frame. Mark and drill 6 mm pilot holes. Secure the oven to the cabinetry by inserting screws through the frame and into the cabinetry.

Only operate the appliance after it has been installed into the cabinetry.



When contacting the Technical Service,  
please quote the model and serial number  
of your appliance.

---

The Miele logo is displayed in a bold, white, serif font against a solid black rectangular background.

**Miele, Inc.** (USA)

**National Headquarters**

9 Independence Way  
Princeton, NJ 08540  
Phone: 800-843-7231  
609-419-9898  
Fax: 609-419-4298  
[www.mieleusa.com](http://www.mieleusa.com)

**Technical Service & Support**

**Nationwide**

Phone: 800-999-1360  
Fax: 888-586-8056

**Miele Limited** (CDN)

**National Headquarters**

55G East Beaver Creek Road  
Richmond Hill, ON L4B 1E5  
Phone: 800-643-5381  
905-707-1171  
Fax: 905-707-0177  
[www.miele.ca](http://www.miele.ca)  
[info@miele.ca](mailto:info@miele.ca) (general enquiries)  
[professional@miele.ca](mailto:professional@miele.ca) (commercial enquiries)

**Mielecare National Service**

Phone: 800-565-6435  
905-850-7456  
Fax: 905-850-6651  
[service@miele.ca](mailto:service@miele.ca) (Tech. Service)