

Miele

Operating Instructions

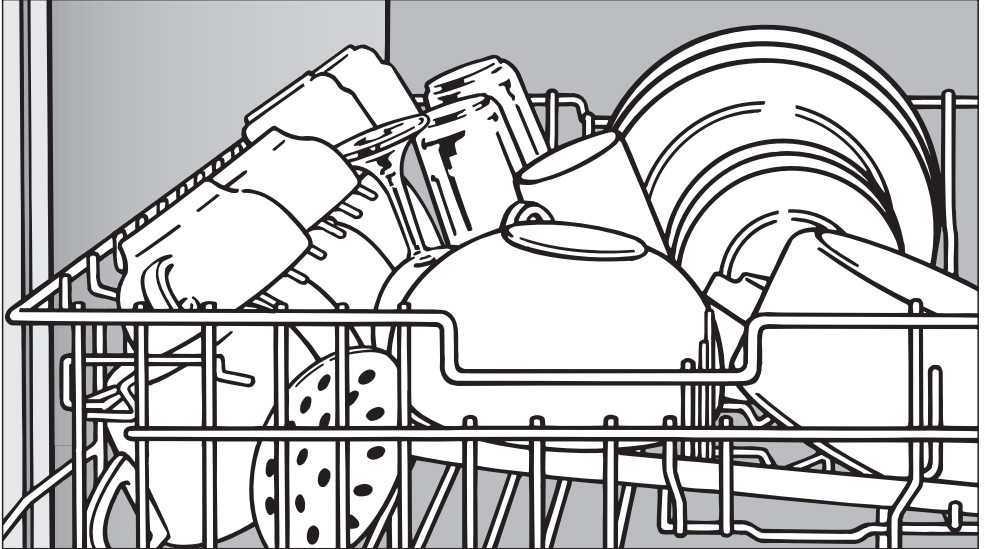

Dishwasher G 1262

To prevent accidents
and appliance damage
read these instructions

before

installation or use.

en - US, CA

M.-Nr. 07 768 790

Contents

IMPORTANT SAFETY INSTRUCTIONS	4
Guide to the dishwasher	7
Caring for the environment	9
Before using for the first time	10
To open the door	10
To close the door	10
Water softener	11
Programming the water softener	12
Filling the salt container	13
Salt indicator	13
Rinse aid	14
Adding rinse aid	14
Rinse aid indicator	15
Adjusting the dosage	15
Loading the dishwasher	16
Items not recommended for dishwashing	17
Cutlery tray	18
Upper basket	19
Adjusting the upper basket	20
Lower basket	21
Basket accessories	24
Use	25
Adding detergent	26
Turning on	27
Selecting and starting a program	27
Program guide	28
Use	29
Time display	29
At the end of a program	29
Preparing your appliance for an extended vacaion	30
Interrupting a program	30
Changing a program	30

Additional options	31
Turbo	31
Tab	31
Delay start	32
Buzzer	33
Default settings	33
Frequently asked questions	34
Technical faults	34
Problems water intake/drain	36
General problems with the dishwasher	37
Sounds	38
Poor cleaning results	39
Comparison tests	42
After sales service	43
Transport	44
User Maintenance Instructions	45
Cleaning and Care	46
Triple filter system	48
Cleaning the spray arms	50
Cleaning the water inlet filter	51
Cleaning the drain pump and non-return valve	52
Installation instructions	53
Help to protect the environment	54
Electrical connection	55
Plumbing	56
Waterproof system	56
Connection to the water supply	56
Drainage	57

IMPORTANT SAFETY INSTRUCTIONS

WARNING -

When using your dishwasher, follow basic precautions, including the following:

Read all instructions before installation or use of the dishwasher to prevent injury and machine damage.

Use the dishwasher only for its intended purpose. This appliance is intended for residential use only.

Keep these operating instructions in a safe place and pass them on to any future user.

Electrical Safety

- ▶ Before installation, make sure that the voltage and frequency listed on the data plate correspond with the household electrical supply. This data must correspond to prevent injury and machine damage. Consult a qualified electrician if in doubt.
- ▶ Before installation or service, disconnect the power supply to the work area by unplugging the unit, "tripping" the circuit breaker or removing the fuse.
- ▶ Do not use an extension cord to connect this appliance to electricity. Extension cords do not guarantee the required safety of the appliance (e.g. danger of overheating).
- ▶ Be certain your appliance is properly installed and grounded by a qualified technician. To guarantee the electrical safety of this appliance continuity must exist between the appliance and an effective grounding system. It is imperative that this basic safety requirement be met. If there is any doubt, have the electrical system of the house checked by a qualified electrician.

IMPORTANT SAFETY INSTRUCTIONS

Installation

▶ The dishwasher must be installed and connected in compliance with the installation instructions.

▶ Installation and repair work should be performed by a Miele authorized service technician. Work by unqualified persons could be dangerous and may void the warranty.

▶ Do not install or use a damaged dishwasher. A damaged appliance is dangerous. Unplug the machine and call your Miele dealer or the Miele Technical Service Department.

▶ Ensure that any plastic wrappings, bags, etc. are disposed of safely and kept out of the reach of children. Danger of suffocation!

▶ This equipment is not designed for maritime use or for use in mobile installations such as recreational vehicles or aircraft. However, under certain conditions it may be possible for an installation in these applications. Please contact the nearest Miele dealer or the Miele Technical Service Department with specific requirements.

▶ It is recommended that the dishwasher only be connected to the mains with the plug (no hard-wiring). The outlet must be accessible at all times after installation to disconnect the dishwasher.

▶  WARNING - Fire hazard
Do not cover or crush the plug of the appliance. Ensure that the cabinet opening for the dishwasher provides ample space for the plug. Installing the dishwasher in a tight space may crimp the power cord or put pressure on the plug which could cause overheating.

▶ This dishwasher should only be installed under a continuous counter top secured to adjacent cabinetry.

▶ Do not install this dishwasher beneath a cooking surface, oven or any appliance that radiates heat. High temperatures from these units may damage the dishwasher.

▶ When installing the dishwasher under a counter top and removing the toe-kick, a build-under toe-kick must be installed. Use the respective installation kit. Danger of injuries.

▶ Do not cut the intake hose or submerge it in liquid. This hose contains electrical components that could cause injury or property damage if cut or submerged.

▶ Only connect the dishwasher to the mains when all installation and plumbing work is complete.

IMPORTANT SAFETY INSTRUCTIONS

Use

- ▶ To reduce the risk of injury, do not allow children to play in, on or near the dishwasher.
- ▶ Only use the dishwasher if all panels are properly in place.
- ▶ Do not tamper with the controls.
- ▶ Do not damage, sit or stand on the door or baskets of the dishwasher. Close the door when not in use.
- ▶ Under certain conditions, hydrogen gas may be produced in a hot water system that has not been used for two weeks or more. **HYDROGEN GAS IS EXPLOSIVE.** If the hot water system has not been used for such a period, turn on all hot water faucets and let water flow from each for several minutes before using the dishwasher. This will release any accumulated hydrogen gas. Do not smoke or use an open flame during this time.
- ▶ Be sure that all items placed in the dishwasher are "dishwasher safe". For items not labeled, check the manufacturer's recommendations.
- ▶ When loading tableware, place sharp items away from the door to prevent damage to the seal. Load sharp items pointing downwards to prevent injuries.

- ▶ Only use detergents and rinse aids recommended for residential dishwashers. Keep all detergents and rinse aids out of the reach of children.
- ▶ Do not inhale or swallow detergents. Dishwasher detergents contain irritant and corrosive ingredients. They can cause burning in the mouth and throat if swallowed, or inhibit breathing. Consult a doctor immediately if detergent has been swallowed or inhaled.
- ▶ Do not drink water from the dishwasher! Harmful residues could be present.
- ▶ Do not fill the rinse aid reservoir with detergent. It will damage the rinse aid compartment.
- ▶ The door will close automatically once pushed against the door catch. Do not put your hand inside of the door as it is closing. Danger of injury.
- ▶ If the power cord is damaged it must only be replaced by a Miele Service technician with a genuine Miele power cord.

Disposal of an appliance

- ▶ If the appliance is removed from its installation site and will not be used, remove the doorlock to the wash cabinet to prevent children from locking themselves in the machine.

SAVE THESE INSTRUCTIONS

Guide to the dishwasher

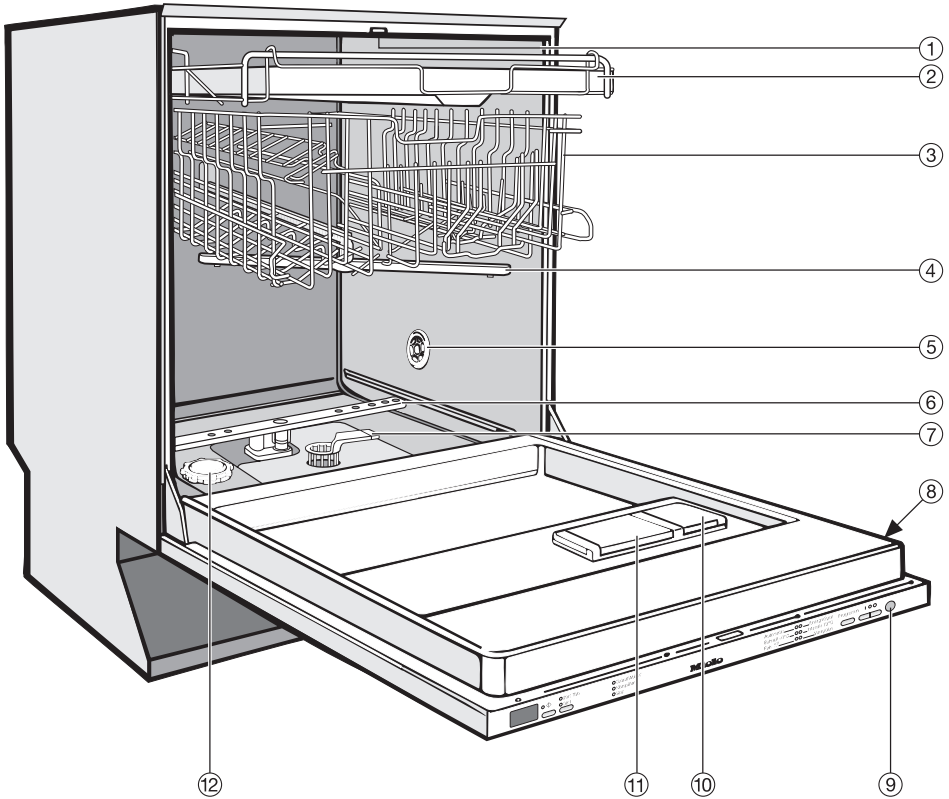



- | | |
|------------------------------------------------|-------------------------------------------|
| ① Upper spray arm (not visible) | ⑦ Triple filter system |
| ② Cutlery tray | ⑧ Data plate |
| ③ Upper basket | ⑨ Optical interface |
| ④ Middle spray arm | ⑩ Rinse aid reservoir |
| ⑤ Air inlet for drying
(depending on model) | ⑪ Dual compartment detergent
dispenser |
| ⑥ Lower spray arm | ⑫ Salt container |

Guide to the dishwasher

Control panel



- ① Time display
- ② Delay Start button  with indicator
- ③ Options button
- ④ Check / Refill indicators
- ⑤ Program selection
- ⑥ Program button
- ⑦ On button  / Indicator
- ⑧ Off button 
- ⑨ Optical Interface

Energy saving washing

This dishwasher is exceptionally economical in the use of water and electricity. For best results follow these tips:

- For lowest energy consumption you may connect the dishwasher to a cold water source.
- For fastest possible wash times, with slightly higher energy consumption, connect the dishwasher to a hot water source.
- Make full use of the baskets without overloading for the most economical washing.
- Use the correct amount of detergent and rinse aid. Detergent dosage is dependent upon the amount of soiling and type of dishware being washed. See the "Program Guide" for more information.
- When using powder or gel detergent, reduce the amount to $\frac{2}{3}$ of the normal amount when washing a small load.
- Choose a program that best suits the degree of soiling and the type of dishes being washed.
- For small loads select "Express".

Before using for the first time

To open the door

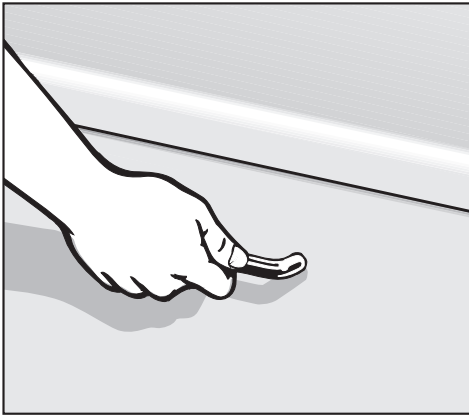

- Pull the handle to open the door.

If the door is opened during operation, the dishwasher will stop running. Once the door is closed the program will continue.

To close the door

- Push the baskets in.
- Lift the door and push until it clicks into position.

Before using for the first time

Water softener

Every dishwasher is tested before leaving the factory. Any water remaining in the machine is from the final factory test and does not indicate that the machine has been used.

To achieve good cleaning results, the dishwasher needs soft water. Hard water results in calcium deposits on dishware and in the dishwasher. If your tap water hardness is above 4 °d (4 gr/gal [US]), the water should be softened.

- The water softener must be filled with dishwasher salt for reactivation. If using "Tab" products which include salt, you should still add salt to the machine to achieve optimal cleaning results.
- Your local water authority will be able to advise you of the water hardness level in your area.
- The dishwasher must be programmed to correspond to the water hardness in your area.

If the hardness of your local supply is constantly lower than 4 °d (4 gr/gal [US]), you do **not need to add water softener salt**. However the water hardness level must still be programmed.

In areas where the water hardness fluctuates (example 37 - 50 °d [39 - 52 gr/gal]) always program the machine to the higher value (in this example 50 °d [52 gr/gal]).

If there is a fault, it will help the service technician to know the hardness of your local water supply.

- Please note your water hardness:
_____ °d (gr/gal)

The water hardness was programmed to 15 °d (16 gr/gal) by factory default

Before using for the first time

Programming the water softener

To exit the programming mode at any time, turn the dishwasher off with the "O" button.

- Turn the dishwasher off with "O".
- Press and hold the "Program" and "I" buttons **simultaneously**. Hold the program button until the lower right program indicator lights.

If it does not come on, start over.

- Press the "Options" button twice.

The "Tab" indicator flashes twice in intervals.

"P 1 5" flashes in the time display.

A water hardness setting of 15 °d is set (factory default).

The set value is indicated in the time indicator following "P" (see table).

°d	gr/gal	Setting in display
1	1	1
2	2	2
3	3	3
4	4	4
5	5	5
6	6	6
7	7	7
8	8	8
9	9	9
10	10	10
11	11	11
12	12	12
13	13	13
14	14	14
15	15	15
16	16	16
17	17	17
18	18	18
19	19	19
20	20	20
21	21	21
22	22	22
23	23	23
24	24	24
25	25	25
26	26	26
27	27	27
28	28	28
29	29	29
30	30	30
31	31	31
32	32	32
33	33	33
34	34	34
35	35	35
36	36	36
37	37	37
38-45	38-45	45
46-60	47-62	60
61-70	63-73	70

- Press the "Program" button to select the value which corresponds with the water hardness in your area. With each press of the button the value will raise. Once the highest value is reached the values will start again from the beginning.
- Turn the dishwasher off with "O".

Before using for the first time

Filling the salt container

 Inadvertently filling the salt container with dishwashing detergent will damage the water softener.

 Only use water softener salt specially formulated for dishwashers. Other salts may contain insoluble additives which can impair the water softener.

- Remove the lower basket and unscrew the salt container lid.

When opening the salt container, water will run out. Open the container only to refill salt.

Important: The salt container must be filled with 1 quart (1 l) of water **before adding salt for the first time.** Water does not have to be added with subsequent refills.

- Place the provided funnel over the salt container. Carefully fill with salt. The salt container holds approx. 3.3 lbs (1 kg) of salt. As it is filled, water will run out.
- Clean any excess salt from the threads of the container opening. Screw the lid on firmly.
- If the dishwasher will not be used immediately, run the "Express" program (without the Turbo function). This will remove any traces of salt from inside the wash cabinet.

Salt indicator

- When the "Salt" indicator comes on, refill the salt after the program has finished.

After the container has been filled, the water softener is automatically reactivated the next time the dishwasher is started. The "Salt" indicator will be lit during this process. It will go out once the reactivation process is complete.

The "Salt" indicator will not light if the dishwasher had been programmed for a water hardness of below 4 °d (4 gr/gal [US]).

Before using for the first time

Rinse aid

Rinse aid helps to prevent spotting on dishes and glassware. The rinse aid is filled in the reservoir and the set amount will be automatically dosed.

 Filling the rinse aid reservoir with detergent will damage the reservoir. Only pour rinse aid formulated for residential dishwashers into the reservoir.

When using "Tab" detergents, rinse aid is not needed.

Adding rinse aid

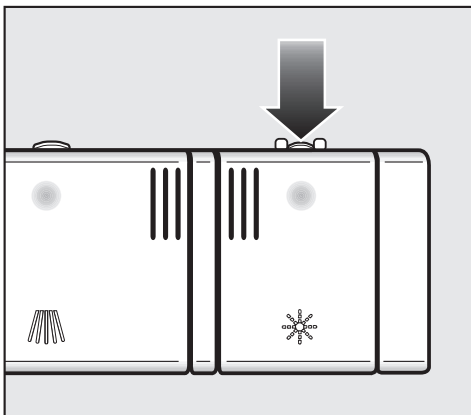

- Press the button in the direction of the arrow until the flap springs open.

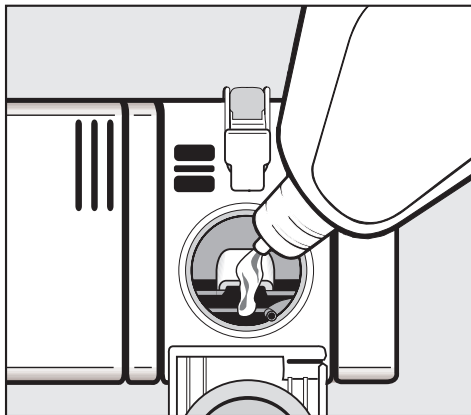

- Pour liquid rinse aid into the reservoir until it is visible on the surface of the screen.

The rinse aid reservoir holds approx. 3.7 oz (110 ml).

- Press on the flap until you hear it click shut. Failure to close it all the way allows water to enter the reservoir during the wash program.
- Clean any spilled rinse aid. The flap will remain closed during normal operation.

Before using for the first time

Rinse aid indicator

When the rinse aid indicator first comes on, there will be enough rinse aid left for 2 - 3 washes.

- The rinse aid indicator on the control panel will light when the rinse aid reservoir needs refilling.

If the "Tab" function is selected, the rinse aid indicator will not light, see "Additional options - Tab".

Adjusting the dosage

The dosage selector is preset to 3. This dispenses approximately 3 ml of rinse aid per program. It can be adjusted from 0 to 6.

- Use a higher setting if spots appear on dry glassware.
- Use a lower setting if streaking appears on dishes or glasses.

- Turn the dishwasher off "O".

- Press and hold the program button and at the same time turn the dishwasher on with "I". Hold the program button until the lower right program indicator lights.

If it does not come on, start over.

- Press the "Options" button 3 times.

The "Tab" indicator flashes 3 times.

The time display shows "P 3" flashing. A rinse aid amount of 3 ml is selected (factory setting).

The set value is shown in the time display after "P".

- Select the desired setting with the program button. Every touch of the button adjusts the level.

The dosage is saved.

- Turn the dishwasher off "O".

Loading the dishwasher

 Do not wash items soiled with ash, sand, wax, grease or paint in the dishwasher.

Ash and sand do not dissolve and will be distributed throughout the inside of the dishwasher.

Wax, grease and paint will cause permanent discoloration and damage to the dishwasher.

- Scrape food from dishes before placing them in the dishwasher, rinsing is not necessary.
- Some foods contain natural dyes, e.g. carrots or tomatoes. Plastic items may discolor permanently if they come in contact with food dyes.
- All items can be placed anywhere in the baskets.
- Load dishes so that water can reach all surfaces. Do not place dishes or cutlery inside other pieces.
- Make sure that all items are securely positioned.
- Hollow items such as cups and glasses should be placed upside down in the baskets.
- To ensure good water coverage, tall, narrow and hollow items, i.e. vases or champagne glasses, should be placed in the center of the basket rather than in the corners.
- Concave based items such as mugs or bowls, should be placed at an angle so that water does not pool.
- The spray arms must not be blocked by items that are too tall or hang through the baskets. Check clearance by manually rotating the spray arms.
- Place very small items in the cutlery tray or basket so they do not fall to the bottom of the wash cabinet.
- Food residue and spilled liquids should be cleaned from the sides of the dishwasher door. These are outside of the wash cabinet and are not cleaned by water from the spray arms.

Items not recommended for dishwashing

- Cutlery with wooden handles
- Wooden cutting boards
- Glued items such as old knives with handles glued together around the shank of the blade
- Handmade craft items, antique, metal trimmed or decorative glassware
- Plastic items that are not heat resistant
- Copper, brass, tin or aluminum
- Dishes with color painted over the glaze. These dishes may fade over time
- Fine glassware and crystal items should only be washed using the "China & Crystal" program*. Otherwise clouding or etching may occur after frequent washing.
- Cast iron pots and pans

* depending on model

If unsure whether your china and crystal are dishwasher safe, please check with the manufacturer. The China & Crystal program, although extremely gentle and thorough can cause the china and crystal to "wear" if they are not dishwasher safe.

Glassware:

- There are no standard guidelines for washing glassware, when in doubt wash by hand.
- When purchasing new dishes, glasses and cutlery, make sure they are dishwasher safe. Only wash items marked "dishwasher safe" in the dishwasher.
- If fine glassware is washed in the dishwasher select the "China & Crystal" program*. This will reduce the risk of clouding.

Silver and aluminum:

- Silver or aluminum items may tarnish.
- Silverware previously cleaned with a silver polish may be damp or spotted at the end of a program where water has adhered to the polish. This can be rubbed off with a soft, dry cloth. Silver that has been cleaned in an immersion dip is usually dry at the end of a program, but may tarnish.
- If left to dry, foods containing sulfur can discolor silver. These include egg yolk, onions, mayonnaise, mustard, fish and marinades.
- Silverware may tarnish or pit if washed next to stainless steel. Leave space between these metals.
- Clean aluminum items, e.g. grease filters, with domestic dishwasher detergent only.

Loading the dishwasher

Cutlery tray

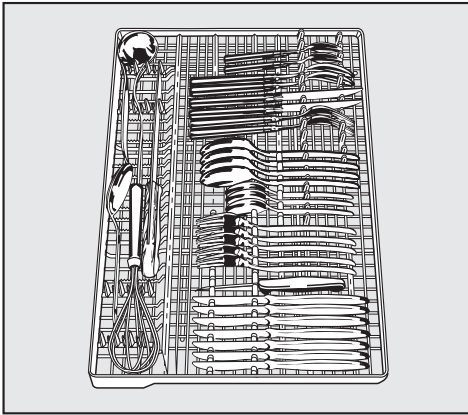

- Arrange the cutlery as shown in the cutlery tray.

For easier unloading cutlery should be grouped in zones, one for knives, one for forks, one for spoons, etc.

Place knives with the cutting edge down and forks with the prongs between the holders. Spoons should be placed in the opposite direction with the handles between the holders so that water can run off more easily.

The upper spray arm must not be blocked by tall cutlery items.

The cutlery tray insert is removable.

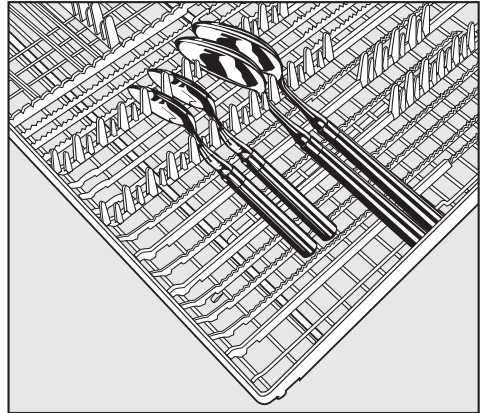

Spoons with thick handles may have to be placed as knives and forks with their heads in the holders.

Loading the dishwasher

Upper basket

 Always use the dishwasher with the upper and lower basket in place.

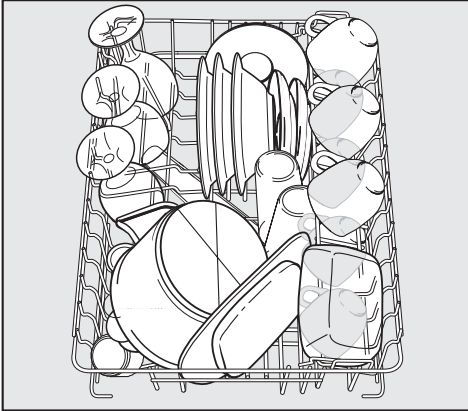

- Load the upper basket with small, lightweight, or delicate items such as cups, saucers, glasses, dessert bowls and flat pans.
- Long items such as soup ladles, mixing spoons and long knives should be placed lying down across the front of the upper basket.

Adjustable cup rack

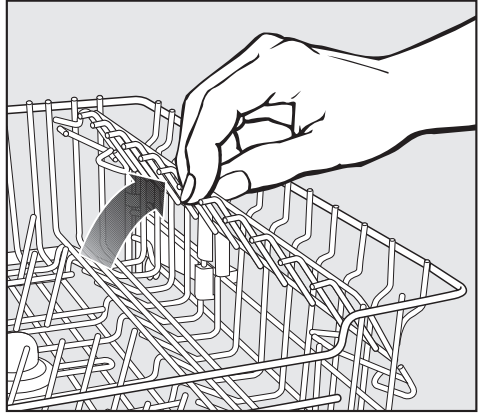

- Raise the rack to make room for tall glasses. Lower it to double stack smaller pieces.

Loading the dishwasher

Adjusting the upper basket

The upper basket can be raised or lowered to accommodate tall items.

The basket can also be angled to fit tall items in both, the upper and lower baskets. The angles should not be set to opposite extremes. This will block the middle spray arm. Take care when sliding the basket in and out in this position.

- Slide out the upper basket.

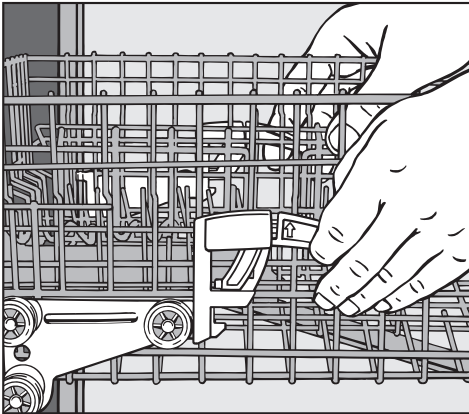

- Pull up the levers at the sides of the upper basket and adjust the basket height.
- Release the levers and the basket will lock in place.

Depending on the setting of the upper basket, a variety of plate dimensions can be accommodated.

For example: If the upper basket is in its highest position a plate with a diameter of $12 \frac{3}{16}$ " (31 cm) can be fit in the lower basket.

Loading the dishwasher

Lower basket

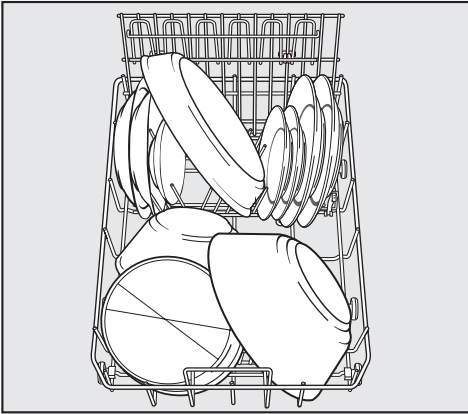

- For larger and heavier items such as plates, serving platters, saucepans, bowls, etc. Small plates and saucers can also be arranged in the lower basket.

Foldable spikes

Both rows of spikes in the front section of the basket can be folded down, to create more room for larger dishware, e.g. pots, pans and bowls.

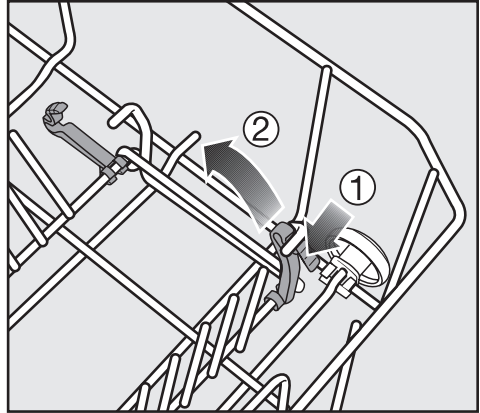

- Press the yellow lever down ① and fold down the spikes ②.

Loading the dishwasher

Removeable PlateGuard Plus with SteamGuard

This insert is ideal for cups, glasses, plates, bowls, pots and pans.

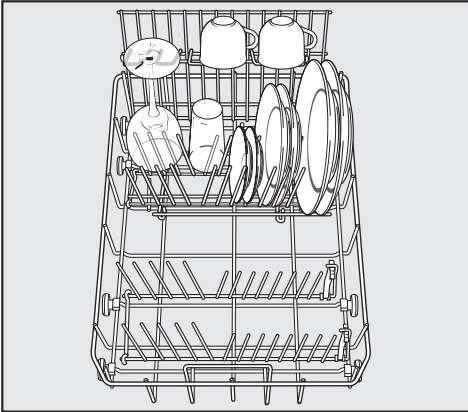

- To arrange tall items the cup rack can be raised.
- The stemguard can be used to hold the stems of glassware or coffee cup handles.

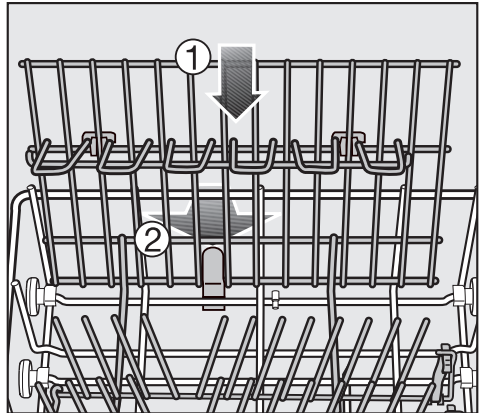

Removing the insert:

- Press the insert downwards ① and at the same time press the catch inwards ②.

Replacing the insert:

- Place the insert back into the lower basket.
- Slide the hitches of the insert under the struts of the lower basket.
- Push down on the handle to snap the insert into position.

Vase / Bottle insert

(depending on model)

The vase / bottle insert can be used to rinse narrow items, e.g. vases, baby bottles, etc.

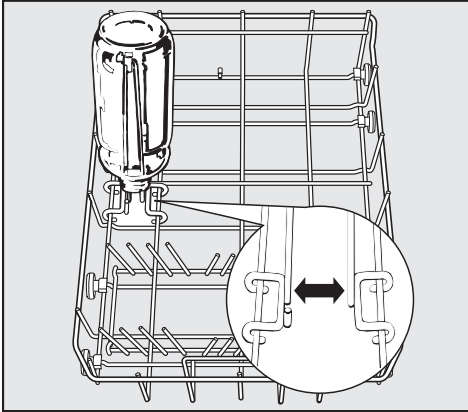

- Place the insert into the lower basket as shown in the illustration. If placed anywhere else, water will not reach all surfaces. The item will not be properly cleaned.

Basket accessories

Additional inserts for the upper and lower baskets may be purchased from your Miele dealer or Miele. Depending on the model some accessories come standard with the machine.

Multi-function basket GMFO	To wash baby bottles, saucers and small items, attaches to the upper basket
Cappuccinatore insert GCEO	To wash the parts of the Cappuccinatore
Large diameter plate insert GTLU 35	To wash plates with a diameter up to 14" (35 cm), attaches to the lower basket
Tall glassware insert GGU	To wash a large number of tall glasses, attaches to the lower basket
Glassware Insert GGO	To wash long stemmed glassware, attaches to the upper basket.

Detergent

 Dishwasher detergents contain irritant and corrosive ingredients. Avoid inhaling or swallowing dishwasher detergent. Keep children away from detergent. Fill the detergent dispenser only when you are ready to start the dishwasher.

 Only use detergents formulated for domestic dishwashers.

Use only the recommended amount of detergent. Continued use of too much detergent may cause machine damage.

When using the "China & Crystal" program (depending on model) reduce the amount of detergent used to at least $\frac{1}{2}$ of the normal dosage. Also make certain your china and crystal are dishwasher safe.

You can use powder, gel or tab detergents. Follow the dosage information on the detergent packaging.

Detergent tabs are not recommended for use with the program "Express". The tabs may not dissolve completely.

Dishwasher cleaning products are available from Mlele.

Use

Adding detergent

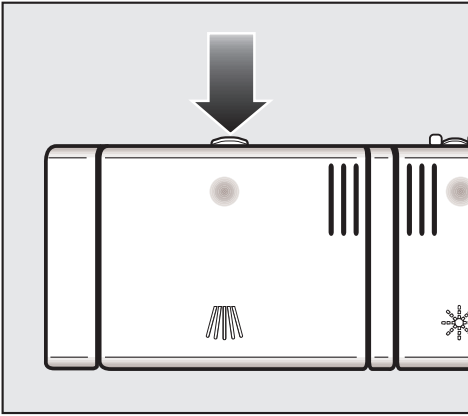

- To open, press the latch on the detergent dispenser. The flap will spring open.

The flap is always open at the end of a program.

- Use one tab or add powder or gel detergent to compartment II and close the flap.

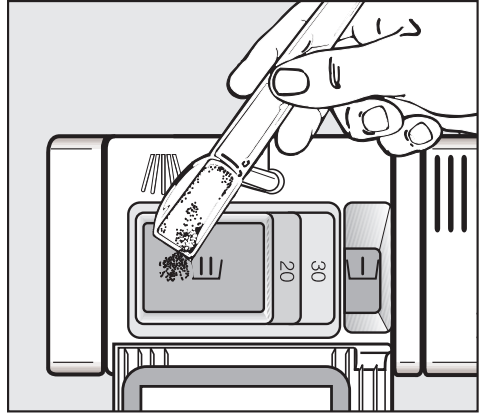

- If a Pre-rinse is desired, and available for your chosen program, add 1 teaspoon (5 ml) of detergent to compartment I.

The horizontal marks in compartment II indicate the levels of approximately 1 ¼ and 2 tablespoons (20 and 30 ml) respectively. Compartment I holds a maximum of 2 teaspoons (10 ml).

Turning on

- Open the water supply, if it is closed.
- Open the door.
- Make sure the spray arms can rotate freely.
- Turn the dishwasher on "I".

The "I" indicator and the indicator of the last set program lights up.

Selecting and starting a program

Choose your program according to the type of load and soiling. See the "Program Guide" for more information.

- Select the desired program with the "Program" button.

The program indicator of the selected program lights. The time display shows the duration of the selected program in hours and minutes.

If the "Turbo" or "Tab" option is selected, the respective indicator lights up

- Select an additional function if desired, see "Additional functions" for more information.
- Close the door.

The program starts.

The optical indicator lights as confirmation of a running program.

Cancel a program only in the first few minutes. Otherwise important program steps (e.g. the water softening) may be interrupted.

Program guide

Program	When to use	Program sequence						
		Pre-rinse		Main wash	Interim rinse		Final rinse	Drying
		1	2		1	2		
Pots & Pans	For normally soiled pots and pans with dried on food , also for heavily soiled dishware, use 120% of normal detergent dose	X		X	X		X	X
Normal	For normally soiled dishware		X	X	X		X	X
China & Crystal	For temperature sensitive glassware and lightly soiled dishware, use 50% of normal detergent amount	as required		X	as required		X	X
SaniWash	Extended wash time, for sanitizing normally soiled dishware with dried on food			X		X	X	X
Express	"Quick program" for lightly soiled dishware, e.g. party dishware Not suitable for detergent tabs			X	X		X	X
Rinse & Hold	To rinse dishes when a complete program is not needed detergent is not recommended	X						

Usage:

Electric 0.01 - 1.23 kWh

Water 1.3 - 5.3 gal (5 - 20 l)

Time display

Before the program starts, the time display shows the running time of the selected program in hours and minutes.

During the running program the remaining time is shown in the time display.

The running time for the same program may vary depending on the intake water temperature, load size and soiling.

When a program is selected for the first time, a time is shown which equals an average program running time with cold water.

Each time a program is run, the electronic adjusts the program running time according to the intake water temperature and the load size.

At the end of a program

At the end of a program the optical function light flashes slowly with the door closed.

After opening the door the time display shows "0".

Dishes tends to chip if removed still hot from the dishwasher.

Let the dishware cool.

After turning off the dishwasher open the door slightly. The dishes will cool much faster.

■ Unload the dishwasher.

Unloading the lower basket first will prevent water drops from the upper basket and cutlery tray (depending on model) from dropping onto dishes in the lower basket.

The optical function light goes out one hour after the end of a program.

■ Turn the dishwasher off "O".

The dishwasher continues to use electricity until turned off with the "O" button.

Use

Preparing your appliance for an extended vacaion

If you elect to turn off the water to your home for an extended period of time, please note that this may not be enough to reduce the risk of a leak.

To be completely safe, you must turn off the water supply to each individual appliance. This means under the sink for a dishwasher, at the laundry bib for your washer, etc.

Interrupting a program

A program is interrupted as soon as the door is opened. If the door is closed, the program will continue from where it was interrupted.

 Open the door with care. The water in the dishwasher is hot. Danger of scalding. Before closing the door again, leave it ajar for approx. 20 secs. This will enable the temperature in the wash cabinet to settle. Close the door firmly until it clicks into place.

Changing a program

If the detergent flap is already open, do not change the program.

If a program has already started and you wish to change it:

- Open the door.
- Press the "O" button.
- Press the "I" button.
- Select the desired program with the program button.
- Close the door.

The optical control lights. The program starts.

Options

With the "Options" button the functions "Turbo" and "Tab" can be selected.

- Open the door.
- Turn the dishwasher on "I".
The I indicator lights up.
- Press and hold the "Options" button until the indicator of the desired function lights up.

The option will remain active for all programs until the setting is changed again.

- A program can now be started as usual or the dishwasher can be turned off "O".

Turbo

The "Turbo" function can be used to reduce the program run-times, in programs in which the option is available.

Using the "Turbo" option during the "Express" program will rinse the dishes without heat, e.g. to avoid smells, if a complete program is not yet needed.

Tab

To achieve the best results, the dishwasher can be programmed for the type of detergent being used. The "Options" button can be used to select between normal detergents (powder or gel) and tabs.

The program sequence is adapted to the selected detergent type. Depending on the program selected the run-time may be extended considerably.

If the "Tab" indicator is not lit, the dishwasher is set for normal detergent.

If the "Tab" indicator is lit than the program sequence is adapted to suit detergents than contain rinse aid (as well as other components where applicable).

The rinse aid dispenser and indicator light are deactivated.

Follow the instructions of the detergent manufacturer.

The cleaning and drying performance of normal detergents versus tabs varies greatly.

Additional options

Delay start

The starting time of a program can be delayed. The start time can be delayed from 30 minutes to 24 hours.

With a delay start time between 30 minutes and 9 hours 30 minutes the delay is set in 30 minute increments. For 10 hours or more it is set in one hour increments.

When using the "Delay Start" function, make sure that the detergent compartment is dry before adding detergent. Wipe dry with a cloth if necessary. Otherwise the detergent could stick together and not completely rinse out. Gel detergent should not be used when selecting "Delay Start", the detergent could leak out of the compartment.

- Open the door.
- Turn the dishwasher on "I".

The indicator "I" lights.

- Select the desired program with the "Program" button.
- Press the "◇" button.

The last set delay start time will show in the time display. The indicator "◇" lights.

- Set the desired delay start time with the "◇" button.

If you press and hold the "◇" button the time will automatically count up to **24h**. To start again at 30 minutes, press the "◇" button twice.

- Close the door.

The time will count down to the program start: in 1-hour-steps over 10 hours, in 1-minute-steps under 10 hours.

Once the delay start time has elapsed, the selected program starts. The display shows the remaining time, the indicator "◇" goes out and the indicator of the selected program lights.

Delay start display

Up to 59 minutes: e.g. 30 minutes = **30**

Between 1 h and 9 h 30 min:
e.g. 5 hours = **5.00**

10 hours and over: e.g. 15 h = **15h**

Starting a program before the delay start has elapsed

A program can be started before the delay start time has elapsed.

- Open the door.
- Press the "O" button.
- Press the "I" button.
- Select the desired program with the "Program" button.
- Close the door.

The optical control lights. The program begins.

Buzzer

A signal sounds at the end of a program and when a fault occurs.

The buzzer at the end of a program sounds five times in quick succession for up to one hour.

The buzzer for a fault sounds in intervals up to two minutes.

The buzzer is activated by default. It can be turned off, so it does not sound at the end of a program. The buzzer for a fault cannot be turned off.

- Open the door.
- Turn the dishwasher off with "○".
- Press the "Program" button and at the same time turn the dishwasher on with "I".
- Hold the program button until the lower right program indicator comes on.

If it does not come on, start over.

- Press the "Options" button four times.

The "Tab" indicator flashes four times in intervals.

The time display shows if the program end buzzer is turned on or off.

- "P 1": Buzzer is turned on
- "P 0": Buzzer is turned off

- Press the "Program" button to change the setting.

The setting is saved.

- Turn the dishwasher off with "○".

Default settings

All settings can be reset to the factory default.

- Open the door.
- Turn the dishwasher off "○".
- Press and hold the "Program" button and at the same time turn the dishwasher on "I". Hold the "Program" button until the lower right program indicator comes on.

If it does not come on, start over.

- Press the "Options" button 12 times.

The "Tab" indicator flashes once long and twice short in intervals.

The time display shows if a setting was changed.

- "P 1": All settings are factory default.
- "P 0": At least one setting was changed.

- To reset the dishwasher to the factory default, press the "Program" button.

The setting is saved.

- Turn the dishwasher off "○".

Frequently asked questions

With the aid of the following guide, minor problems can be fixed without a service call.

 Repairs should only be carried out by a qualified and trained person in accordance with local and national safety regulations. Unauthorized repairs could cause personal injury or machine damage.

Technical faults

Problem	Possible fault	Solution
The program does not start.	The door is not properly closed.	Close the door firmly.
	The machine is not plugged in.	Insert the plug.
	The fuse is defective or the breaker has tripped.	Reset the circuit breaker. See data plate for minimum amperage.
	The dishwasher is not turned on.	Turn the dishwasher on "I" and select a program.
The dishwasher stops during a program.	The fuse has tripped.	Reset the circuit breaker. See data plate for minimum amperage.
The optical indicator is not visible when a program has started.	The reflector was not properly installed.	Install the reflector properly, see the separate "Installation sheet".

Frequently asked questions

Problem	Possible fault	Solution
The optical indicator flashes. The buzzer sounds. All program indicators are flashing fast when the door is open. The time display shows FXX.	There may be a technical fault.	Turn the dishwasher off "○". After a few seconds: <ul style="list-style-type: none">– Turn the dishwasher on.– Select the desired program with the program button.– Close the door. If the problem persists contact Technical Service.
The drain pump is running when the door is opened.	Fault F70: The waterproof system has activated.	<ul style="list-style-type: none">– Turn off the water supply.– Contact Miele Technical Service.

Frequently asked questions

Problems water intake/drain		
Problem	Possible fault	Solution
The optical indicator flashes. The buzzer sounds. The "Intake / Drain" indicator flashes when the door is open.	The water supply is shut off.	<ul style="list-style-type: none"> – Open the water supply.
The dishwasher stops. The optical indicator flashes. The buzzer sounds. The "Intake / Drain" indicator flashes when the door is open. The time display shows FXX.		Before fixing the fault: <ul style="list-style-type: none"> – Turn the dishwasher off "○".
	Fault F12/F13: Water intake fault	<ul style="list-style-type: none"> – Open the water supply. – Clean the water intake filter, see "User Maintenance Instructions". – The water pressure at the water connection is lower than 4.35 psi. Consult a plumber.
	Fault F11: Water drain fault. There may be water in the wash cabinet.	See "User Maintenance Instructions". <ul style="list-style-type: none"> – Clean the triple filter. – Clean the drain pump and the non-return valve. – Remove any kinks in the drain hose.

Frequently asked questions

General problems with the dishwasher		
Problem	Possible fault	Solution
The display turns off.	The dishwasher has gone into "Standby" mode to save energy.	Press any button. The display turns on again.
Detergent is left in the dispenser at the end of a program.	The dispenser was damp when detergent was added.	Dry the dispenser before adding detergent.
The detergent lid cannot be closed properly.	Detergent residue is blocking the catch.	Remove the residue.
The door and the interior walls are still wet after a program has finished.	This is not a fault! It is the normal operating mode of the drying system.	The moisture will evaporate after a short time.
Water remains in the wash cabinet at the end of a program.		Before fixing the fault: – Turn the dishwasher off "O".
	The triple filter in the wash cabinet is clogged.	Clean the triple filter. See "User Maintenance Instructions".
	The drain pump or the non-return valve may be blocked.	Clean the drain pump and the non-return valve, see "User Maintenance Instructions".
	The drain hose is kinked.	Remove any kinks from the drain hose.

Frequently asked questions

Sounds		
Problem	Possible fault	Solution
There is a knocking noise in the wash cabinet.	The spray arm is hitting an item in the basket.	Interrupt the program, rearrange items blocking the spray arms.
There is a rattling noise in the wash cabinet.	Items are not secure in the wash cabinet.	Interrupt the program and rearrange loose pieces.
There is a knocking noise in the water pipes.	This may be caused by the installation or the diameter of the pipe.	This has no effect on the dishwasher. If in doubt contact a plumber.

Frequently asked questions

Poor cleaning results		
Problem	Possible fault	Solution
The dishes are not clean.	The dishes were not loaded correctly.	See "Loading the dishwasher".
	The program was not powerful enough.	Select a more intensive program, see "Program Guide".
	Not enough detergent was dispensed.	Use more detergent, see "Adding detergent".
	The spray arms are blocked by items.	Turn the spray arm and rearrange the dishes if necessary.
	The triple filter is clogged or not correctly inserted. The spray arm jets may be clogged.	Clean the filter and insert the filter correctly, see "User Maintenance Instructions".
	The drain pump or the non-return valve is blocked. Wash water will run back into the wash cabinet.	Clean the drain pump and the non-return valve, see "User Maintenance Instructions".
Glasses and cutlery show streaks. There is a bluish sheen on the surface of glasses and film that can be wiped off.	The rinse aid dosage is set too high.	Reduce the dosage, see "Before using for the first time".

Frequently asked questions

Problem	Possible fault	Solution
Dishes are not dry, glasses and cutlery are spotted.	The rinse aid setting may be too low, or the rinse aid reservoir is empty.	Increase the dosage, refill the reservoir or switch the rinse aid product when refilling, see "Before using for the first time".
	Dishes were taken out too soon.	Leave dishes in longer, see "Use".
	A "Tab" product was used. These products have a low drying effect.	Set the Detergent setting for a normal detergent and add rinse aid.
	The "Tab" option is turned on, but a normal product was used.	Set the Detergent setting to the detergent used, see "Additional options - Tab".
White residue is visible on cutlery and dishes. Clouding occurs on glassware and film can be wiped off.	Not enough rinse aid was used.	Increase the dosage, see "Before using for the first time".
	Unsuitable "Tab" products were used.	Change detergent, use normal tabs or normal powder detergent.
	The salt container is empty (depending on model).	Refill the salt container, see "Before using for the first time".
	The salt container lid was not correctly screwed on (depending on model).	Reseat the lid making sure its screws back on correctly.

Frequently asked questions

Problem	Possible fault	Solution
Glasses are discolored and the film cannot be wiped off.	Detergent deposits.	Use a different detergent.
Clouding or etching on glasses.	Possible causes may be : excessive rinse aid, incorrect water hardness level set, type and amount of detergent. Any one or a combination of these faults may be to blame.	See the relevant section of this manual to: <ul style="list-style-type: none"> – adjust the rinse aid dosage, – adjust the water hardness level, – change the type and/or adjust the amount of detergent used, – connect the dishwasher to a cold water supply.
Glasses are dull and discolored, film cannot be wiped off.	Glasses are not dishwasher safe.	There is no remedy. Only wash dishwasher safe glasses in the dishwasher.
Tea or lipstick stains have not been completely removed.	The wash temperature of the selected program was too low.	Select a program with a higher temperature.
	The detergent has a low bleaching effect.	Use a different detergent.
Plastics are discolored.	Natural dyes e.g. from vegetables may be the cause. Not enough detergent was used to break down natural dyes.	Use more detergent, see "Adding detergent". Discoloration is permanent.
There are rust stains on cutlery.	The affected items are not corrosion resistant.	There is no remedy. Only wash dishwasher safe cutlery in the dishwasher.
	A program was not run after refilling salt (depending on model). Salt residuals got into the wash cycle.	Start the "Express" program (empty and without the Turbo function) after refilling the salt.
	The salt container lid was not screwed on properly (depending on model).	Reseat and screw the lid on firmly.

Comparison tests

10 place settings, Standard program: **Normal**

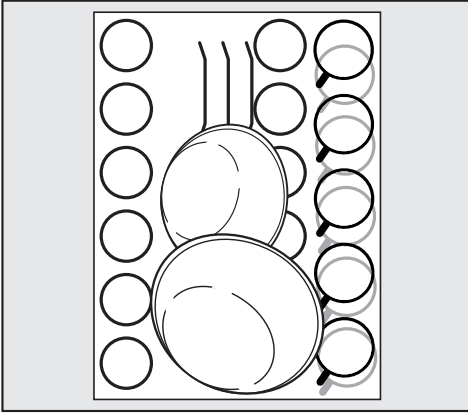

Upper basket

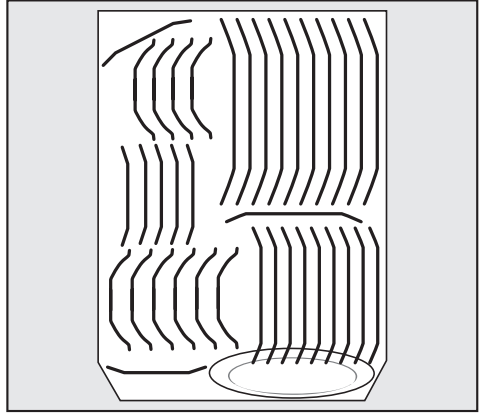

Lower basket

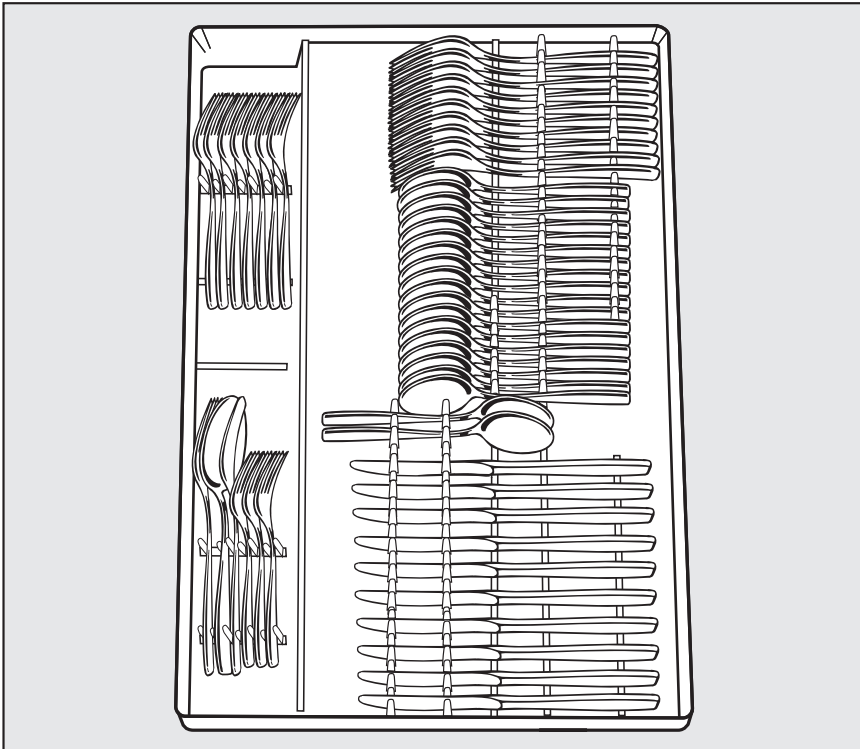

Cutlery tray

Repairs

In the event of a fault which you cannot correct yourself please contact the Miele Service Department at the phone number on the back of this booklet.

- Please quote the model type and number of your appliance.

These can be found on the data plate along the right edge of the door.

PC Update

The Program Correction (PC) allows a technician to update the dishwasher to make use of new technology.

When, for example, technological developments offer advanced modifications to your existing program cycles a service technician will be able to input these into your machine controls via the indicator light marked PC. Miele will provide information when such possibilities become available.

MieleCare

(USA only)

MieleCare, our Extended Service Contract program, gives you the assurance of knowing that your appliance investment is covered by 5 years of worry free ownership.

MieleCare is the only Extended Service Contract in the industry that guarantees repairs by a Miele Authorized Service Provider using genuine Miele parts. Only genuine Miele parts installed by factory trained professionals can guarantee the safety, reliability, and longevity of your Miele appliance.

Please note that unless expressly approved in writing by Miele's Service department, Extended Service Contracts offered by other providers for Miele products will not be recognized by Miele. Our goal is to prevent unauthorized (and untrained) service personnel from working on your Miele products, possibly doing further damage to them, you and/or your home.

To learn more about **MieleCare** Extended Service Contracts, please contact your appliance dealer or visit us online at:

<http://mieleusa.com/mielecare>

Transport

To transport the dishwasher, e.g. when moving to a new home, note the following:

- Empty the dishwasher.
- Secure any loose parts, e.g. hoses, cables, cutlery baskets.
- Transport the dishwasher in the upright position. If unavoidable it may be transported on its back. Do not transport it on its side or on the door. Residual water in the machine could leak and cause electrical damage.

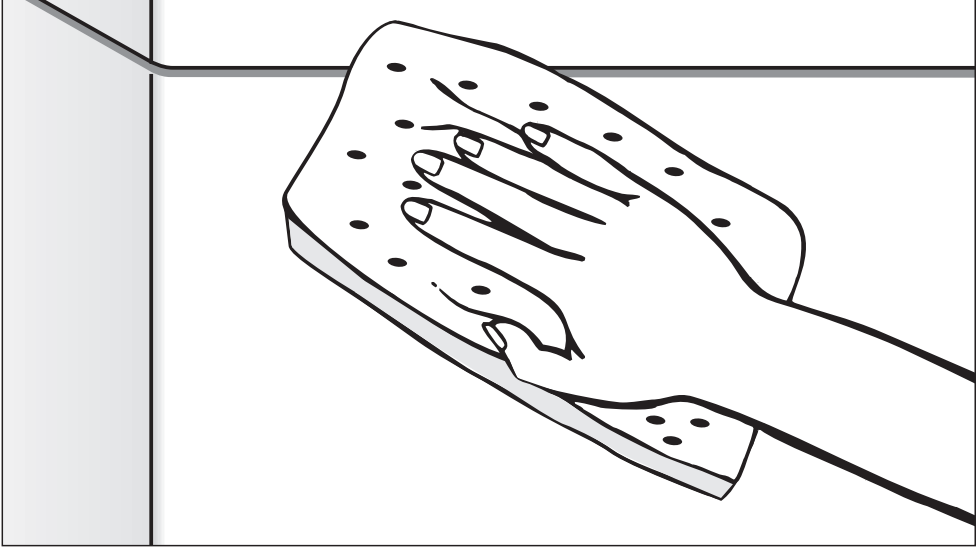

User Maintenance Instructions

To prevent accidents
and appliance damage,
read these instructions

before
installation or use.

Cleaning and Care

Check and clean your dishwasher regularly. This will help avoid faults and problems.

 Abrasive cleaning agents, all-purpose cleaners, thinner or ammonium cleaners should not be used on the dishwasher. They **will** damage the surface.

Wash cabinet

Generally, the wash cabinet is self cleaning if the correct amount of detergent is used.

The wash cabinet can be cleaned with a dishwasher cleaner such as "Dis Cleaner" available from your Miele dealer, Miele or online at www.miele.com.

Door and the door seal

- Wipe the door seals regularly with a damp cloth to remove food deposits.
- Food residue and spilled liquids should be wiped from the sides of the dishwasher door. These are outside of the wash cabinet and are not cleaned by water from the spray arms.

Exterior

- Use a conditioner suitable for your kitchen cabinetry.
- Clean wood with a damp cloth and wipe dry.

Clean the exterior with a solution of warm water and liquid soap applied with a soft sponge. Dry with a soft cloth.

Glass cleaners may be used to clean the exterior. However **do not** allow them to sit or "puddle", this can cause damage to the surface.
Remove the cleaner promptly.

To better maintain your appliance avoid the following:

- cleaners containing soda, ammonia, thinners, or chlorides
- cleaners containing descaling agents or lime removers,
- abrasive cleaners,
- stainless steel cleaners,
- dishwasher soap (powder),
- caustic (oven) cleaners,
- scouring pads, steel wool, hard brushes,
- metal scrapers.

Indicator reflector

The reflector of the optical interface is located in the steam deflector beneath the counter top.

- Clean as necessary with a damp cloth.

Control panel

- Clean the control panel as necessary with a damp cloth.

 The appliance front and controls are not scratch proof. Remove spills immediately.

Cleaning and Care

Triple filter system

The triple filter system in the base of the wash cabinet prevents food from being redeposited on dishes. It also protects the circulation pump from damage caused by foreign objects (e.g. broken glass, bones). During normal use, the filter system is self-cleaning.

 The machine must not be used without all the filters in place!

- Check and clean the filter system periodically for any trapped or foreign objects.

The level of soiling and time it takes before the filters need cleaning will vary depending on your household usage.

- Turn off the dishwasher before cleaning.

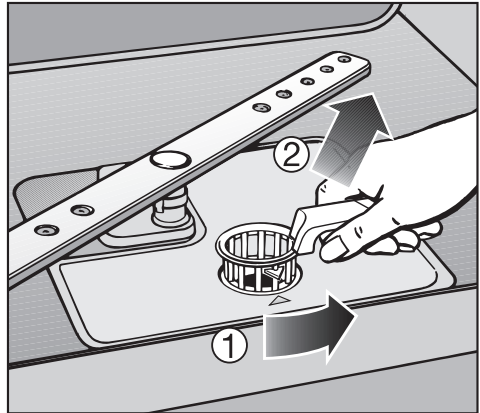

- Turn the handle counterclockwise to release the triple filter system ①.
- Lift the filter combination out of the machine ②. Remove any solid particles and rinse under running water. Scrub with a nylon brush if necessary.

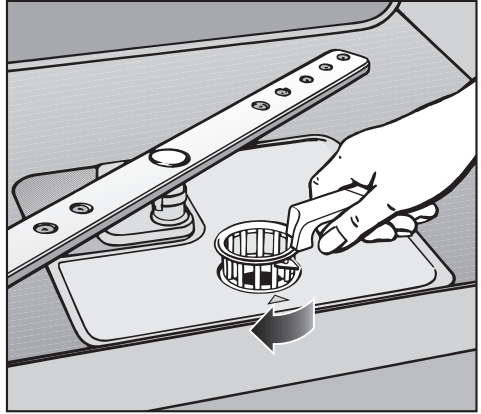
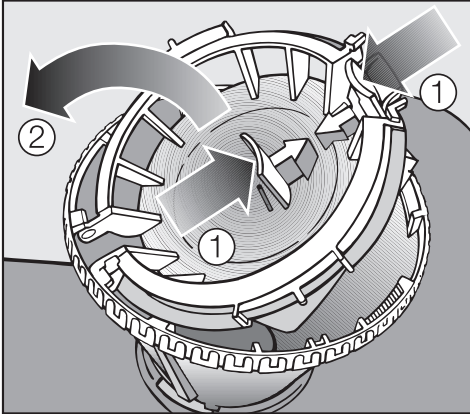

To clean the inside of the filter, the flap must be opened.

- Push the clips together ① and open the flap ②.
- Rinse under running water.
- Close the flap so that the clip engages.

- Return the filter so it lies flat in the base of the wash cabinet.
- Lock the filter by turning the handle clockwise.

 The triple filter system must be inserted and locked into place. Large particles could get in the circulation system and cause a blockage.

Cleaning and Care

Cleaning the spray arms

Sometimes particles of food get stuck in the spray arm jets. The spray arms should be inspected and cleaned every 4 - 6 months.

- Turn off the dishwasher before cleaning.

Removing the spray arms

- Remove the cutlery tray (if present).
- Push the **upper** spray arm up to engage the inner ratchet and unscrew the spray arm.

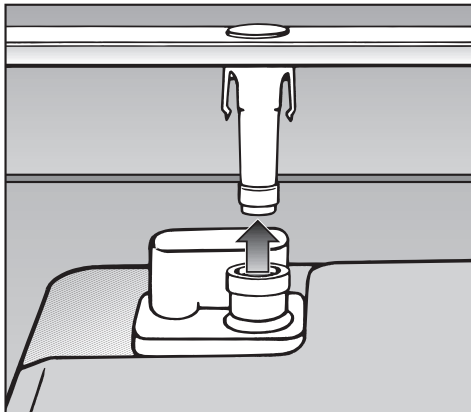

- Pull the **lower** spray arm firmly upwards to remove.

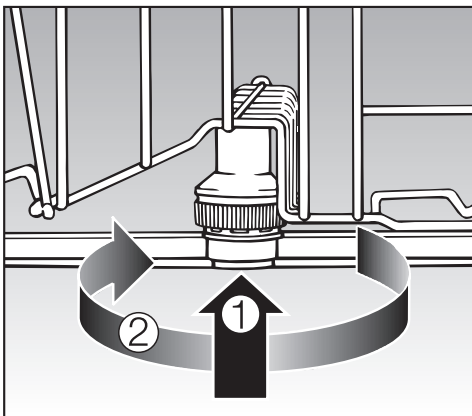

- Lift up the **middle** spray arm, ①, to engage the ratchet and unscrew the spray arm, ②.
- Remove the lower basket.

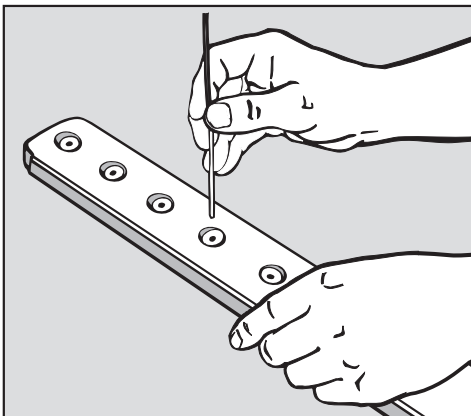

- Use a pointed object such as a toothpick to push food particles into the spray arm jets.
- Rinse thoroughly under running water.
- Return the spray arms and check that they rotate freely.

Cleaning the water inlet filter

A filter is incorporated into the intake hose attached to the dishwasher's shut off valve. If your water is hard or the pipes contain sediment, this filter may clog and prevent enough water from entering the wash cabinet.

 The plastic housing of the water connection contains electrical wiring.
Do not cut the intake hose or submerge it in liquid.



Installing an in-line water filter

If your water contains a large number of insoluble substances, a filter between the water valve and the intake hose connection is recommended. These filters can be purchased from Miele.

Cleaning the filter

- Turn off the dishwasher and pull the plug.
- Turn off the water supply.
- Unscrew the intake hose.

- Carefully remove the rubber seal.
- Remove the filter using needle nose pliers and rinse it under running water.
- Reinsert the filter and seal. Make sure they are seated correctly.
- Screw the intake hose back on the water valve, checking that it is not cross-threaded.
- Slowly turn on the water supply and test for leaks.

Cleaning and Care

Cleaning the drain pump and non-return valve

If the dishwasher is not completely drained at the end of a program, the drain pump or non-return valve may be blocked.

- Turn off the dishwasher and pull the plug.
- Remove the triple filter (see "Triple filter system").
- Use a cup or bowl to scoop water out of the wash cabinet.

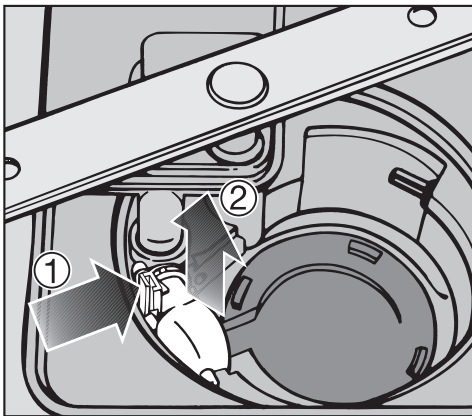

- Tilt the locking clamp to the side ①.
- Pull out the non-return valve ② and rinse it under running water.
- Remove all foreign objects from the non-return valve.

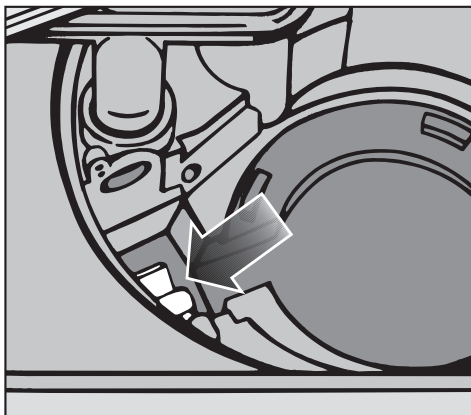

The drain pump is beneath the non-return valve (see arrow).

- Remove all foreign objects from the drain pump (glass or bone splinters).
- Before returning the non-return valve, check that the drain pump is not blocked. Spin the propeller several times in both directions to check for obstructions.
- Carefully reinsert the non-return valve and secure it with the locking clamp.

 Make sure the locking clamp clicks into place!



Installation Instructions

Please refer to the Installation Diagram supplied with these instructions.

To comply with IEC sound testing protocols, please contact Miele for additional instructions.

Information is subject to change. Please refer to our website to obtain the most current product specification, technical & warranty information.

Help to protect the environment

Disposal of the packing material

The cardboard box and packaging protect the appliance during shipping. These materials are biodegradable and recyclable. Please recycle.

Ensure that any plastic wrappings, bags etc. are disposed of safely and kept out of the reach of children.
Danger of suffocation!

Disposal of an old machine

Old appliances may contain materials that can be recycled. Please contact your local recycling authority about the possibility of recycling these materials.

Ensure that the appliance presents no danger to children while being stored for disposal. Before discarding an old appliance, unplug it from the outlet, cut off its power cord and remove any doors to prevent hazards.

 Installation, repairs and other work by unqualified persons could be dangerous.

Check that the voltage, frequency and fuse rating shown on the data plate match the household mains supply.

The power outlet must be accessible after installation. Do not use an extension cord to connect the dishwasher to the mains. Danger of overheating! See data plate on the right side of the door.

A damaged power cord must only be replaced with a genuine Miele cord by a Miele service technician.

GROUNDING INSTRUCTIONS

THIS APPLIANCE MUST BE GROUNDED.

In the event of a malfunction or breakdown, grounding will reduce the risk of electric shock by providing a path of least resistance for the electrical current. This appliance is equipped with a cord having an equipment grounding conductor and a grounding plug. The plug must be plugged into an appropriate outlet that is installed and grounded in accordance with all local codes and ordinances.

 **Improper connection of the equipment grounding conductor can result in electric shock. Do not modify the plug provided with the appliance; if it will not fit the outlet, have a proper outlet installed by a qualified electrician. If there is any question concerning the proper electrical connection or grounding of this appliance to the power supply, please consult a licensed electrician or call Miele's Technical Service Department:**

 1-800-999-1360

 1-800-565-6435

Specifications

The dishwasher comes equipped with a 4 ft (1.2 m) power cord with a molded plug for connection to 120 V, 60 Hz, 15 A grounded receptacle.

Plumbing

Waterproof system

All Miele dishwashers have a safety valve located on the incoming water line and a sealed underside with a water sensor. If a fault occurs, the water intake is stopped and the drain pump is activated.

Connection to the water supply

 Do not drink water from the dishwasher!

- The dishwasher can heat its own water to the temperature required by the wash program. This allows for connection of the machine to either a hot or cold water source. For lowest energy consumption connect the dishwasher to a cold water source. For fastest possible wash times, with slightly higher energy consumption, connect the dishwasher to a hot water source. All programs use hot water in the rinse cycles.
- The inlet hose is approximately 5 ft. (1.5m) long.
- A 5 ft. (1.5m) drain extension is available from Miele.
- The water inlet hose comes equipped with a 3/4" female hose thread connector. This can be directly connected to a water supply with 3/4" MHT (male hose thread ends).
- Water pressure: Must be between 4.5 - 145 psi (0.3 - 10 bar).

 To prevent damage to the dishwasher, it must only be connected to a fully vented drainage system.

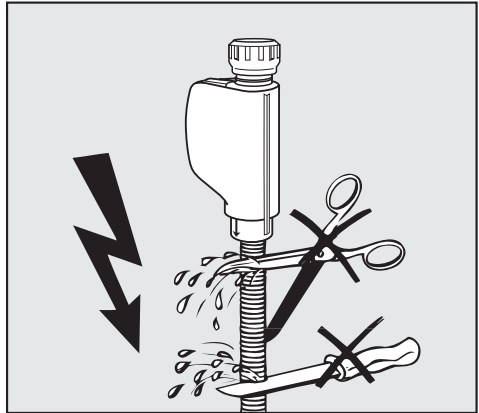

 Do not cut the intake hose. It contains electrical wiring. If the hose is cut, the dishwasher will not work. There will be a water leak and you could be injured. If the hose is too long, coil it neatly and place it behind the machine.

Drainage

- The machine comes equipped with a built-in non-return valve on the discharge side to prevent waste water from flowing back into the dishwasher.
- The dishwasher is equipped with a 5 ft (1.5 m) flexible drain hose with an internal diameter of 7/8" (22 mm).
- Drain hose extensions and adapters can be ordered from Miele. The maximum drain hose length is 13 ft. (4 m), max. drain height: 39" (1 m).
- If the hose is to be directly fitted to the drainage outlet on site, use the supplied hose clip (see assembly plan).
- The hose can be installed to the left or right side.
- The existing drain pipe for the drain hose is designed for various hose diameters. The drain pipe must be shortened if the drain pipe extends too far into the drain hose. The drain hose could get clogged.
- The drain hose must not be shortened.

 Make sure the hose is installed without kinking, pressure or being pulled.

Venting the drainage system

If the dishwasher drain hose is connected to a floor drain or to a drain pipe that is less than 8" (20 cm) above the floor, the drain must be vented. Otherwise the water inside the dishwasher may siphon out during the wash program.

- Open the dishwasher door and remove the lower basket.
- Pull the lower spray arm firmly upwards to remove.

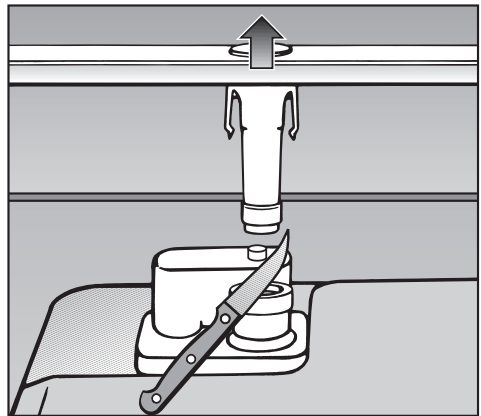

- Cut off the vent cap located at the right rear of the triple filter system, as illustrated.

**Please have the model and serial number
of your appliance available before
contacting Technical Service.**



U.S.A. Miele, Inc.

National Headquarters

9 Independence Way
Princeton, NJ 08540
Phone: 800-843-7231
609-419-9898
Fax: 609-419-4298
www.mieleusa.com

Technical Service & Support Nationwide

Phone: 800-999-1360
Fax: 888-586-8056

TechnicalService@mieleusa.com

Canada Miele Limited

Headquarters and Showroom

161 Four Valley Drive
Vaughan, ON L4K 4V8
Phone: 800-643-5381
905-660-9936
Fax: 905-532-2290
www.miele.ca
professional@miele.ca
(commercial enquiries)

MieleCare National Service

Phone: 800-565-6435
905-532-2272
Fax: 905-532-2292
customercare@miele.ca
(general and technical enquiries)

Germany

Miele & Cie. KG
Carl-Miele-Straße 29
33332 Gütersloh

Alteration rights reserved / 1711
G1262

M.-Nr. 07 768 790 / 02



INFORMATION IS SUBJECT TO CHANGE. PLEASE REFER TO OUR WEBSITE TO OBTAIN THE MOST CURRENT PRODUCT SPECIFICATIONS, TECHNICAL & WARRANTY INFORMATION.