

Operating and Installation Instructions PW 6080 Vario

To prevent accidents
and machine damage
read these instructions

before
installation or use.

en - US

M.-Nr. 09 145 960

Contents

IMPORTANT SAFETY INSTRUCTIONS	4
Guide to the Washer	8
Control panel	8
Display	9
Operating the washer	11
Tips	12
1. Sort the laundry	12
2. Load the drum	13
3. Select a program	13
Wash care label symbols	14
Quick guide	15
Select a program	19
Selecting/changing a program	19
Favorites	21
Saving a favorite program	21
Extras	22
Pre-wash	22
Starch stop	22
Rinse hold	23
Intensive*	23
Water plus*	23
Timer	24
Spin speed	25
Maximum final spin speed	25
Rinse and interim spin	25
Changing the program sequence	26
Coin mechanism	26
Interrupting a program	26
To cancel a program	26
Changing a program	26
Detergent	27
Washing with several components	28
Fabric softeners / liquid starch	29
Automatic dispensing of fabric softener or liquid starch	29
External dispensing system	30
Empty sensor	30
Cleaning and care	32

Contents

Cleaning the machine	32
Cleaning the inlet hose filter	35
Frequently asked questions	36
The program does not start	36
A fault message appears in the display	37
General problems	38
Poor wash results.	39
The door will not open	40
To continue a program after a power failure	40
Opening the door during a power failure or when the drain is blocked	41
Drain the machine.	41
Cleaning the drainage system	42
Opening the drum door	43
After sales service	44
Installation instructions	45
Installation	46
Front view.	46
Rear view	47
Installation site	49
Removing the shipping struts	51
Re-fitting the shipping struts	51
Leveling the machine.	52
Plumbing	53
Recycled water connection	54
Hot water supply.	54
Drainage	55
Drain pump.	55
Electrical connection	56
Technical data	57
Help protect our environment.	58

IMPORTANT SAFETY INSTRUCTIONS

 **WARNING** - To reduce the risk of fire, electric shock or injury to persons while using your appliance follow basic safety precautions, including the following:

Read all instructions before installation or use to prevent injury and appliance damage.

This appliance conforms to all uniform safety codes and regulations.

Keep these operating instructions in a safe place and pass them on to any future user.

SAVE THESE INSTRUCTIONS

WARNING - To reduce the risk of fire, electric shock or injury:

Correct application

▶ Only use the washing machine to wash items which are specified by the manufacturer to be machine washable on the fabric care label. Any other applications may be dangerous.

▶ Persons who lack physical, sensory or mental abilities, or experience with the appliance should not use it without supervision or instruction by a responsible person.

▶ Do not allow children to play on or in the appliance. Close supervision is necessary when the appliance is used near children.

▶ It is the responsibility of the operator to ensure that the standard of disinfection procedures is maintained according to your local authority. Disinfection programs must not be interrupted, as this can have a limiting effect on the disinfection result.

▶ The drum door glass will be hot when washing at very high temperatures.

Do not touch the glass. Danger of burns! Keep children away from the washer when in use.

▶ If the machine is used in a publically accessible room, it is the supervisor's responsibility to ensure that suitable measures are in place which enable operators to use it safely.

▶ If this machine is being used in a commercial environment please ensure that all relevant health and safety regulations are obeyed.

▶ This appliance is not designed for maritime use or for use in mobile installations such as recreational vehicles or aircraft. However, under certain conditions it may be possible for an installation in these applications. Please contact the Miele Technical Service Dept. with specific requirements.

IMPORTANT SAFETY INSTRUCTIONS

Technical safety

▶ Check the packaging, the washer and accessories for any signs of damage. Do not use a damaged appliance.

▶ GROUNDING INSTRUCTIONS

This appliance must be grounded. In the event of malfunction or breakdown, grounding will reduce the risk of electric shock by providing a path of least resistance for electric current. This appliance is equipped with a cord having an equipment-grounding conductor and a grounding plug. The plug must be plugged into an appropriate outlet that is properly installed and grounded in accordance with all local codes and ordinances.

▶ **WARNING** - Improper connection of the equipment-grounding conductor may result in a risk of electric shock. Check with a qualified electrician if you are in doubt as to whether the appliance is properly grounded.

▶ Do not modify the plug provided with the appliance - if it will not fit into the outlet, have a proper outlet installed by a qualified electrician.

▶ Before connecting the machine, ensure that the connection data on the data plate (fusing, voltage and frequency) match the main electrical supply. If in doubt contact an electrician.

▶ Do not use an extension cord to connect this appliance to the power supply. Extension cords do not guarantee the required safety of the appliance (e.g. danger of overheating).

▶ Do not install your washing machine in rooms where temperatures below freezing may occur. Frozen hoses may burst under pressure. The reliability of the electronic control unit may be impaired at temperatures below freezing.

▶ Before using the washer for the first time, remove the shipping struts at the back of the appliance (see "Installation"). Failure to remove the shipping struts can damage the washer and surroundings during spinning.

▶ During extended absences (e.g., vacation), close the water supply.

▶ **Danger of flooding!**
Before hanging the drain hose in the sink, make sure the water will drain away quickly enough. Secure the hose. The force of the water exiting the hose can cause an unsecured hose to pop out of the sink.

IMPORTANT SAFETY INSTRUCTIONS

- ▶ Do not repair or replace any part of the appliance or attempt any servicing unless specifically recommended in these operating instructions.
- ▶ Ensure power is not supplied to the appliance while maintenance or repair work is being performed. The machine is only completely isolated from the electrical supply when it is turned off at the main switch and the plug is pulled, or by tripping the circuit breaker.
- ▶ Connect the washer, to the water mains. Do not use old hoses. Inspect the intake hoses regularly for damage. They should be replaced as needed to prevent water damage.
- ▶ Faulty components must only be replaced with genuine Miele spare parts.
- ▶ If the power cord is damaged it must only be replaced by a Miele Service technician with a genuine Miele power cord.
- ▶ Under certain conditions, hydrogen gas may be produced in a hot water system that has not been used for 2 weeks or more. **HYDROGEN GAS IS EXPLOSIVE.** If the hot water system has not been used for such a period, turn on all hot water faucets and let the water flow from each for several minutes before using the washing machine. This will release any built-up hydrogen gas. Do not smoke or use an open flame during this time, the gas is flammable.

IMPORTANT SAFETY INSTRUCTIONS

Safety

- ▶ Do not wash articles that have been previously cleaned, washed, soaked or spotted with gasoline, dry-cleaning solvents or other flammable substances. These articles give off vapors that could ignite or explode. Do not add these items to the wash load.
- ▶ Do not add gasoline, dry-cleaning solvents, or other flammable or explosive substances to the wash water. These substances give off vapors which could ignite or explode.
- ▶ Do not use cleaning solvents on or near the machine or the controls. Contact with cleaning solvents will damage the surface.
- ▶ Do not use a pressure washer or hose to clean the machine.
- ▶ Ensure that no foreign objects are left in pockets (e.g. nails, coins, paper clips, etc.) this can cause damage to clothes and the machine.
- ▶ Proper dosing of the detergent will eliminate the need to remove lime deposits. However, if heavy limescale does form on the washer, select a descaling agent with corrosion protection. Closely follow the instructions on the product package.

▶ It is particularly important to observe manufacturer's instructions when using a combination of cleaning agents and special application products. Only use the product for the application described by the manufacturer, to avoid any material damage or the occurrence of strong chemical reactions.

Accessories

▶ Only use genuine Miele accessories. If unapproved parts are used, guarantee, performance and product liability claims may become void.

Disposing of your old machine

▶ Before disposing of an old machine it is important to disable the door lock. This way you will prevent the risk of children accidentally locking themselves in and endangering their lives.

SAVE THESE INSTRUCTIONS

Guide to the Washer

Control panel

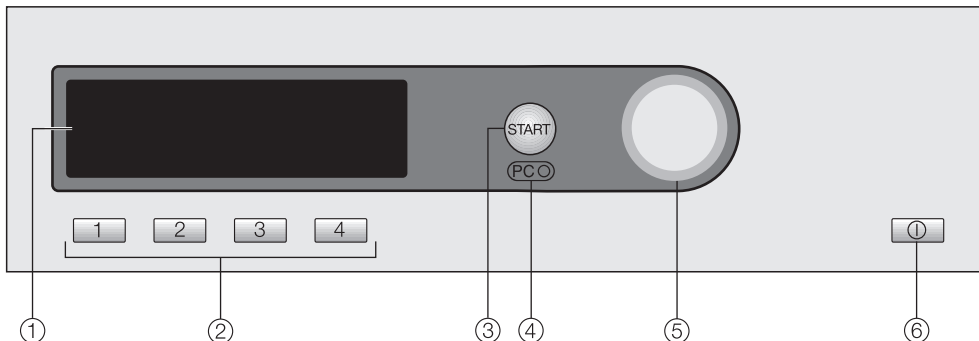

① Display

See the following pages for more information.

② Direct select buttons

To select a wash program directly. You can also save a "Favorite" wash program on these buttons.

③ Start button

④ PC / Optical interface

Allows a service technician to check and update the wash programs

⑤ Jog shuttle

Turn to select menus
Press to confirm the selection

⑥ On-Off button ①

* Contents in the display will vary with program offering

Before using for the first time

Before using the machine for the first time ensure that it is correctly installed and connected. See "Installation". Also check that the drain filter is securely tightened to prevent the risk of water leaks during use.

See the separate booklet supplied with the machine "Commissioning the machine / Program chart / Settings".

Display

Display contents will vary with program offering.

Main menu

1	Cottons Uni.	60°C	Program selection...
2	Minimum iron	40°C	Settings ▶...
3	Delicates	40°C	
4	Woollens 	30°C	10:00

When the machine is turned on, the display shows the main menu (with "Favorites" listed). "Program selection" is highlighted.

If the display is dark (in Standby mode) turn the jog shuttle.

Jog shuttle

Turn the jog shuttle to select a program or setting.

Press the jog shuttle to confirm the selection.

Direct select buttons





The first four programs shown in the display on the left are the "Favorites". They can be selected with the direct select buttons.

The Favorites can be individually set to your desire. See "Favorites" for more information.

The direct select buttons have different functions in the other menus. In these menus an arrow ▼ is displayed above the respective button with the function description of the button.

Program selection options

There are two ways of selecting a program:

- Option 1: Select and confirm the menu "Program selection" in the display with the jog shuttle.
- Option 2: Press one of the direct select buttons     for direct access of the basic menu for the selected program.

Guide to the Washer

Program selection menu



All programs can be selected with the jog shuttle. Depending on the direction the jog shuttle is turned the highlighter moves up or down.

The arrows ▼▲ at the right side of the display show that more selections are available.

- Press the jog shuttle to open the basic menu of the selected program.

Wash program main menu

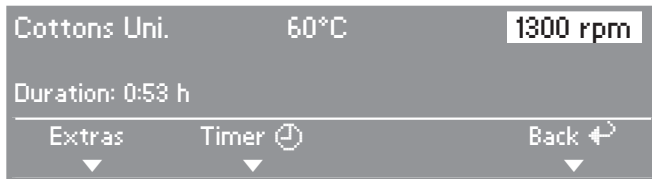

The program components (program, temperature and spin speed) can be selected by turning the jog shuttle. The selected component is highlighted. Press the jog shuttle to select the component. The respective submenu is displayed.

The submenus "Extras" and "Timer" can be selected with the direct select buttons.

- To go back to the main menu press 4 "Back".

All components can also be selected and confirmed using only the jog shuttle.

Settings menu

The "Settings" menu allows you to adjust the washer to individual needs. See "Settings" for more information.

Operating the washer

The appearance of the main menu will vary depending on the "Control" setting selected.

The machine is operated either with the direct select buttons **1**, **2**, **3**, **4** or the jog shuttle.

WS direct select buttons, basic

1	Cottons Uni.	60°C
2	Minimum iron	40°C
3	Delicates	40°C
4	Woollens 	30°C

Four programs are available. To specify which programs are available go to the "Settings - Supervisor level" menu.

WS direct select buttons + Logo



Twelve programs are available. To specify which programs are available go to the "Settings - Supervisor level" menu.

Tips

1. Sort the laundry

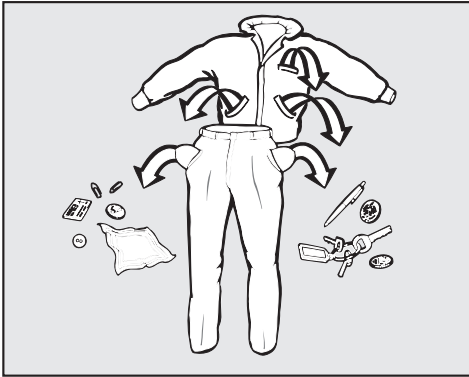

- Empty all pockets.

 Foreign objects left in pockets (e.g. nails, coins, paper clips, etc.) can cause damage to clothes and the machine.

- Pre-treat stains.

Tough stains (blood, egg, coffee, tea etc.) or badly soiled areas (collars and cuffs) should be pre-treated with a stain remover or a paste made of powder detergent and warm water. Dab stains with a damp light colored cloth. Do not rub.

 Do not use chemical solvents in the machine.

- Sort the laundry.

General tips

- Dark fabrics often bleed the first few times they are washed. They should be washed separately several times before being included in a mixed load.
- Remove any lead weights or strips from curtains before washing.
- Loose under-wires should be removed or sewn in place before washing.
- Woolens and knitted garments should be turned inside out.
- Close zippers and hooks and eyes before washing.
- Comforter covers and pillowcases should be fastened in order to prevent small items from getting trapped inside of them.

Do **not** machine wash items if it is not recommended on the fabric care label ( symbol).

2. Load the drum

- Switch the machine on with the ① On/Off button.
- To open the drum door pull on the handle.

Do not use force as it is fitted with a safety device to prevent it being opened by mistake. Forcing the door handle can cause damage to the locking mechanism (see "Frequently asked questions - The door will not open").

- Load the laundry loosely into the drum.

For best results, wash mixed loads of small and large items. This will improve washing effectiveness and help distribute the load evenly.

The most efficient use of energy and water is achieved when a full load is washed. However, do not overload as this causes creases and reduces cleaning efficiency.

 Make sure that no items are caught between the door and the drum.





- Close the drum door. Press the door firmly shut then lock the handle into position.
Do not slam the door.



3. Select a program





- Select an appropriate program for your wash load.





See the separate booklet supplied with the machine "Commissioning the machine / Program chart / Settings".



Wash care label symbols

Washing	
The number shown in the bucket is the maximum temperature the garment can be washed at. The number of bars under the symbol indicate the level of agitation permitted.	
	No bar under the symbol: = normal agitation
	One bar under the symbol: = reduced agitation
	Two bars under the symbol: = much reduced agitation
	Hand wash (if no temperature is specified use the lowest temperature or cold)
	Do not wash

Drying	
The number of dots indicates the drying temperature	
	Normal temperature
	Low temperature
	Do not tumble dry

Ironing	
The number of dots indicates the ironing temperature	
	Hot iron (max sole plate temp. approx. 392°F/200°C)
	Medium hot iron (max sole plate temp. approx. 302°F/150°C)
	Cool iron (max sole plate temp. approx. 230°F/110°C). Do not steam iron garments carrying this symbol.
	Do not iron

Professional cleaning	
	Dry clean only. The letters indicate the type of cleaning agent required.
	
	Professional Wet Clean only
	Do not dry clean

Bleaching	
	Any oxidizing bleaching agent can be used
	Only use an oxygen based bleach or a non-chlorine bleach
	Do not bleach

⚠ Be sure to read both the "Tips" and "Wash care label symbols" sections before starting a wash load.

① Sort the laundry

② Load the drum

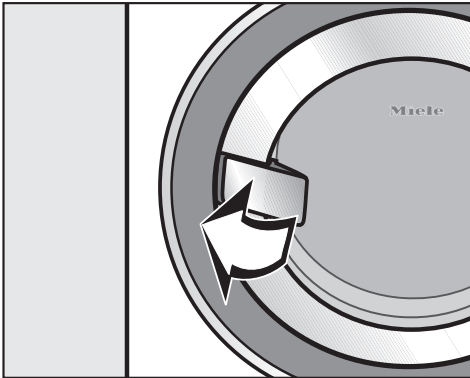

■ Turn on the machine.



■ Open the drum door.

■ Load the laundry loosely into the drum.

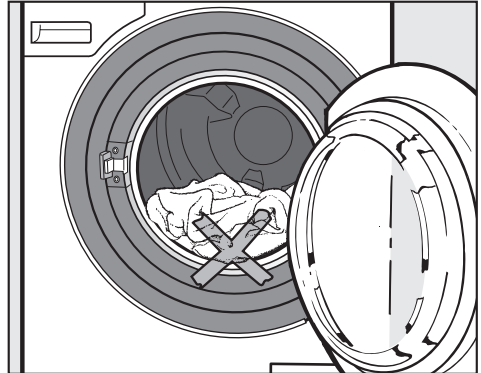

⚠ Make sure that no items are caught between the door and the drum.

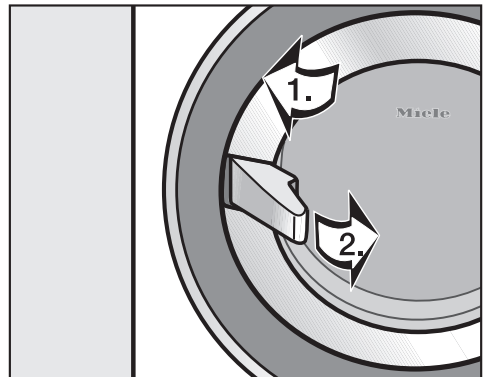

■ Close the drum door (1.). Press the door firmly shut then lock the handle into position(2.). Do not slam the door.

Quick guide

③ Select a program

- Select the most appropriate program for the load being washed.

See the separate booklet supplied with the machine "Commissioning the machine / Program chart / Settings" for a list of available programs.

You can select a program either by:

- selecting a "Favorite" by pressing the respective direct select button, or

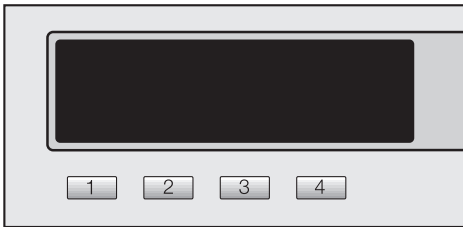

- selecting from the "Program selection" menu by turning the jog shuttle.

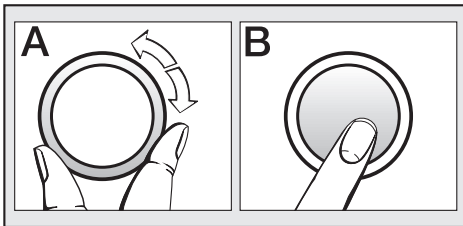

- If desired, select "Extras" and/or a "Timer" start time with the respective submenus.

Coin mechanism

If a coin mechanism operates the machine, please regard the displayed request to pay.

If the door is opened after a program has started or if the program is canceled the credit is lost.

④ Adding detergent

Use detergent according to the laundry soiling and water hardness.

Too little detergent may cause:

- Laundry not getting properly clean, and with time may become grey and hard to the touch.
- Greasy particles clinging to laundry.
- Limescale deposits on the heater elements.

Too much detergent may cause:

- Over sudsing with minimal drum movement; poor wash, rinse and spin results.
- Higher environmental burden.

See "Detergent" for more information.

This machine is set up for connection to an external dispensing system for dispensing liquid agents (see "Detergent - External dispensing system").

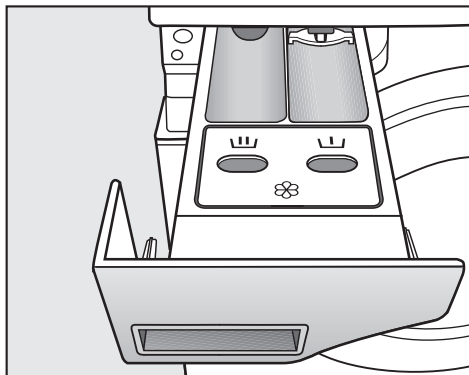

- Pull out the detergent drawer and add detergent to the compartments as follows:

☰ = Detergent for the pre-wash
($\frac{1}{4}$ of the total recommended amount of detergent)

☰ = Detergent for the main wash

☼ = Fabric softener or liquid starch

- Close the detergent drawer.

The detergent drawer must not be opened during a program. It must remain closed while the machine is in use.

The ☼ compartment is not used during disinfection programs. Do not put anything in the ☼ compartment.

Quick guide

⑤ Starting a program

"Start" flashes when a program can be started.

- Press the "Start" button.

The "Start" button lights.

The display shows the approximate program run time. It will count down in minutes. In the first 10 minutes the washer calculates the water absorbency of the laundry. The overall program time may be shortened or lengthened.

Additionally the sequence cycle is displayed. The washer shows the current program step.

Press one of the following direct select buttons during the running program:

- Button 1 "Extras" can be used to select or de-select extras.
- Button 2 "Timer" the time of day and the approximate program end is displayed.
- Button 4 "Cancel" to cancel the currently running program. The wash water will be drained away.

⑥ At the end of a program

"Finish" will appear in the display.

- Open the drum door.
- Remove the laundry.

Check the drum for any missed pieces of laundry. Items inadvertently left in the washer may get damaged (e.g. shrink or discolor) during the next wash cycle.

- Close the drum door. Otherwise foreign objects may find their way into the drum. These could be inadvertently washed and cause damage to laundry.
- Turn the machine off using the "On/Off" button.

Selecting/changing a program

Main menu

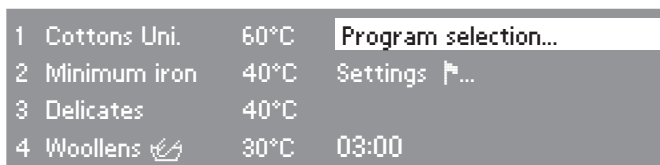

- Press direct select button **1**.

Main menu



- Using the jog shuttle you can then highlight the following options in the display: Program, Temperature or Spin speed and confirm your selection by pressing the jog shuttle.

Depending on the option highlighted, the following will be displayed:

– Program selection



- Use the jog shuttle to select the desired program and confirm. The main menu will reappear.

Select a program

Note: If you do not make a selection in the sub-menu within approx. 15 seconds, the display will revert to the main menu.

– Temperature selection

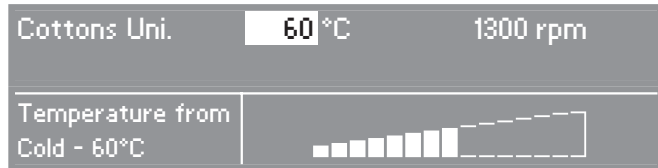

- Select the desired temperature with the jog shuttle and confirm. The main menu will reappear.

– Spin speed selection

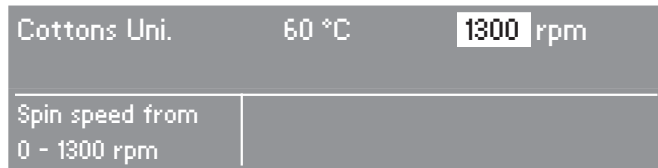

- Select the desired spin speed with the jog shuttle and confirm. The main menu will reappear.

Select an Extra option(s)

- Press direct select button . The submenu "Extras" shows.

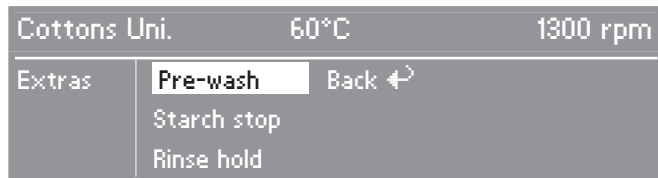

- Select the desired Extra with the jog shuttle and confirm. The basic menu shows again. Repeat if another Extra is desired. See "Extras" for more information.

The washer has the option to save the most used wash programs on the direct select buttons. The option "Save" must be selected in "Settings - Supervisor level" before the direct select buttons can be programmed.

Saving a favorite program

Main menu

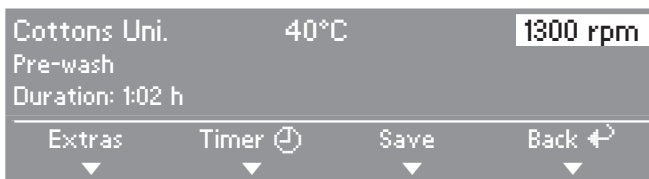

- Press direct select button .

Selecting a direct select button

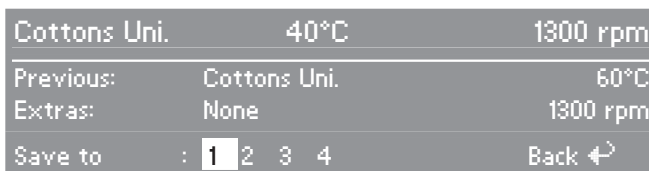

- Use the jog shuttle to select the number you want to save the program to, and confirm your selection. Your settings have now been saved and the favorite program will appear in the main menu.

Repeat the procedure if you want to customize other favorite programs, and save them to direct select buttons which have not yet been used.

Extras

The basic wash programs can be enhanced with "Extras".

Accessing the submenu "Extras"

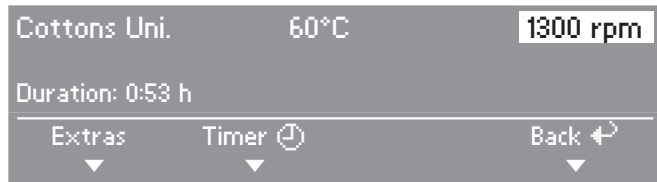

- Press direct select button 1. The submenu "Extras" shows.

Select an Extra option(s)

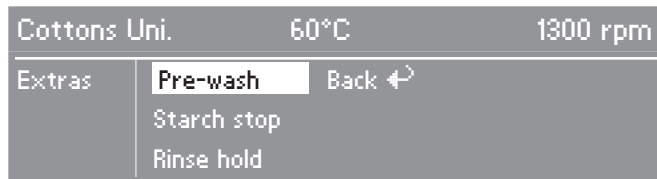

- Select the desired Extras with the jog shuttle and confirm.
 - Repeat if another Extra is desired.
 - A selected Extra is marked with a check mark.

Pre-wash

For laundry with heavy soiling e.g. dust, sand.

Starch stop

The water is drained away before the last rinse and the program stops.

Add the starch directly to the laundry in the drum and continue the program. See "Detergent - Separate starch" for more information.

Rinse hold

The washer stops after the last rinse, the laundry remains soaking in water. This will prevent wrinkles if the laundry is not removed immediately at the end of the wash program.

Intensive*

For laundry with normal to heavy soiling or stains.

The total time for the wash program will be extended.

Water plus*

The washer comes factory set with the Extra selection "Water plus" activated. The water level during washing and rinsing is increased.

See the separate booklet supplied with the machine "Commissioning the machine / Program chart / Settings" to select additional settings.

* "Intensive" and "Water plus" can be added in "Settings - Supervisor level".

Extras which can be selected are shown in the submenu "Extras". If an Extra is not shown, it is not available for the selected program.

Timer

The timer option allows you to select the program end time. The program start can be delayed from 30 minutes to 24 hours.

Select the submenu Timer

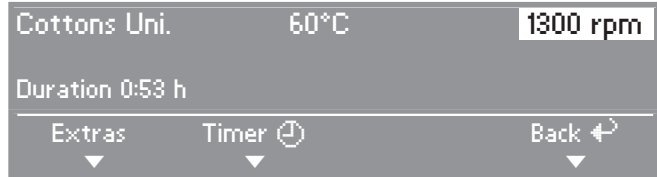

- Press the direct select button **[2]**. The "Timer" menu appears.

Selecting a Delay start time

The program end can be selected in 30 minute increments.

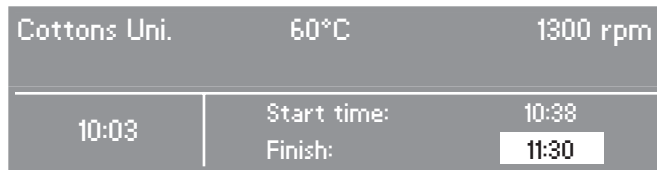

- Select the desired program end time with the jog shuttle and confirm. The program end time is adjusted to the next full or half hour. The program start will be delayed according to the desired program end time.

Starting the Timer

- Press the "Start" button.

The elapsed timer time is displayed and will count down in minutes.

Canceling the Timer

- The Timer can be canceled with the direct select button **[4]**.

The actual load size can only be determined accurately by the machine once the program has started. This can cause the finish time for the program to vary.

Maximum final spin speed

The maximum final spin speed will vary depending on the program chosen.

The final spin speed can be reduced. However, you cannot select a final spin speed higher than that permitted for the program selected.

Rinse and interim spin

There is a spin after the main wash and between the rinses. A reduction in the final spin speed will also reduce the interim spin speed.

Without final spin

- Select "Rinse hold" from the submenu "Extras". The laundry is not spun and remains soaking in water. This will prevent wrinkles if the laundry is not removed immediately at the end of the wash program.

- To start the final spin:

The Spin speed is highlighted in the display.

- Start the final spin by pressing the Start button.

- You can alter the spin speed.

- Press the jog shuttle and change the spin speed as desired.

- Then confirm your choice. The spin will begin.

- To end the program:

- Press direct select button "Cancel". The water will drain away.

- Open the drum door.

Deselect rinse spin and final spin

- Select "Without spin". The laundry is not spun after the final rinse but the water is drained away.

Changing the program sequence

Coin mechanism

Credit will be lost if the program is canceled after it has started.

Interrupting a program

You can interrupt a program which is in operation at any time.

- Turn the machine off with the "On/Off" button.

To continue with the same program:

- Turn the machine back on with the "On/Off" button.
- Confirm the message shown in the display and press the "Start" button.

To cancel a program

You can cancel a program at any time after it has started:

- Press direct select button  "Cancel".

The wash water will be drained away.

- Open the drum door before starting a new program.

Changing a program

After the program start the spin speed can be selected until the final spin starts. The Extras "Starch stop" and "Rinse hold" can be selected or deselected.

You can change the temperature and select or deselect the "Intensive" and "Water plus" options during the first 5 minutes of the program.

You will not be able to change or cancel the program or to open the door if :

- a disinfection program is running, or
- a payment system is connected to the machine (depending on setting it may be possible to cancel a program. See Settings "Coin mechanism lock".

Detergent dispensing

Please follow the detergent manufacturer's instructions.

Only use laundry detergent formulated for front loading washing machines.

For wool and wool blend fabrics use a detergent formulated for wools.

Follow instructions on the detergent packaging for the correct use and amount of detergent.

The amount of detergent used depends on the level of soiling:

Light soiling

No soiling or stains are visible

Normal soiling

Some visible soiling or a few light stains

Heavy soiling

Very visible soiling or stains

The size of the load and the water hardness level in your area have an impact on the amount of detergent necessary to obtain optimum wash results. If you do not know the water hardness level in your area, contact your local water authority.

Water hardness

Hardness level	Water quality	Water hardness in gpg (also German hardness in °d)	Water hardness in mmol/l
I	soft	0 - 7	0 - 1.3
II	moderate	7 - 14	1.3 - 2.5
III	hard to very hard	over 14	over 2.5

Water softener

If the water hardness level is between II and III, you can soften the water to reduce detergent consumption.

The detergent packaging should indicate the correct amount to use in your machine. Add the detergent, then add the water softener. From then on you can then use the recommended amount of detergent for water hardness level I.

Detergent

Washing with several components

If you wash using several components (e.g. special application detergents), it is recommended to dispense the agents into compartment  in the following order:

1. Detergent
2. Water softeners
3. Stain remover

This will allow the agents to distribute more evenly.

Dye removers / Fabric dyes

Do not use dye removers in this washer.

- When dyeing fabrics in the washer, adhere to the manufacturer's instructions.

Fabric softeners / liquid starch

- Dispense according to the amount specified on the packaging.

Automatic dispensing of fabric softener or liquid starch

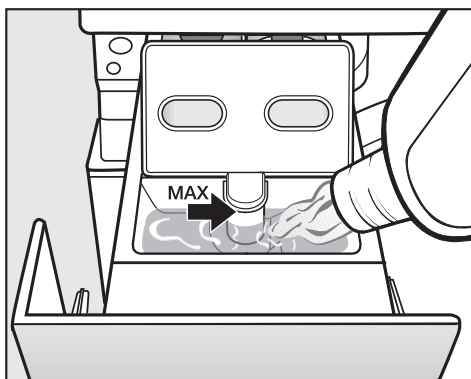

- Add the fabric softener or liquid starch to compartment ☼. **Do not exceed the Max. level mark.**

The softener or liquid starch is automatically dispensed in the final rinse. At the end of the program a small amount of water remains in the fabric softener compartment ☼.

If you use starch frequently, clean the dispenser compartment and especially the siphon tube and conditioner channel. See "Cleaning the detergent drawer". Do not use powder starch formulations or viscous liquid starch in the ☼ compartment, this may cause clogging.

Separate fabric softener

- Add fabric softener to the ☼ compartment.
- Select the "Extra rinse" program.
- Press "Start".

Separate starch

- Prepare and dispense the amount of starch recommended on the packaging.
- Add starch to the ☼ compartment.
- Select the program "Starch".
- Press "Start".

Starching with Starch Stop

- Prepare and dispense the amount of starch recommended on the packaging.
- Before starting a program select the "Starch stop" extra option. The program and the "Remaining time" indicator will pause before the last rinse. "Starch stop" will appear in the display.
- Open the drum door and add the prepared starch to the laundry in the drum.
- Close the drum door.
- Select and confirm a spin speed, or
- press the "Start" button.

Detergent

External dispensing system

The machine is fitted with an adapter for an external dispensing system. Up to six dispensing hoses (not supplied) can be connected to the machine. The external pumps are controlled by relays in the machine. Each relay is turned on for 2 minutes at a time.

A separate connection box for electrically controlling the dispensing pumps is required, and must be fitted by a Miele service technician.

The relay is controlled as described in the separate booklet supplied with the machine "Commissioning the machine / Program chart / Settings" to select additional settings.. The containers must be filled with the correct detergent or disinfectant in the order specified.

Empty sensor

When the "Empty sensor" is activated, a message appears in the display to show when an external liquid agent container is empty (see "Settings - Supervisor level" in the separate booklet supplied with the machine "Commissioning the machine / Program chart / Settings").

If a container is empty, the following message will appear in the display before the start of the program or while the program is running:



A program that has already been started continues to run until it has finished.

- Press direct select button to delete the message in the display, and refill the container.

If a **Disinfection program** is running the following message is displayed:

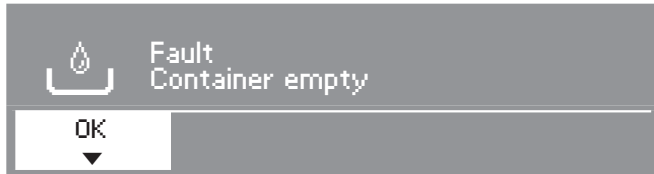

The program will be canceled.

- Press direct select button , to delete the message in the display. Refill the container.
- Start the program again.

 If the container is empty for a disinfection program, it can be assumed that **disinfection has not taken place**. Restart the program.

Cleaning and care

 Before cleaning the appliance, disconnect the power supply by unplugging the unit or manually tripping the circuit breaker.

Never clean the machine or near its vicinity with a water or high pressure hose.

 Do not use chemical solvents, abrasive cleaners, glass or all purpose cleaners. These can damage plastic surfaces and other parts.

Cleaning the machine

- Clean the exterior of the washer with a mild solution of non-abrasive detergent or soap and water. Wipe dry with a soft cloth.
- Clean the drum with a stainless steel cleaner specially formulated for use in a washing machine, follow the manufacturer's instructions on the packaging.

Cleaning the drum and drainage system

The drum and drainage system can be cleaned if necessary.

- Start the "Maintenance program".
- At the end of the program check the inner drum and remove any coarse residues.

If you use disinfection programs on a regular basis, the "Maintenance program" should be run frequently.

Cleaning the detergent dispenser drawer

Detergent residue should be cleaned out regularly.

There is a yellow tool behind the detergent drawer fascia panel.

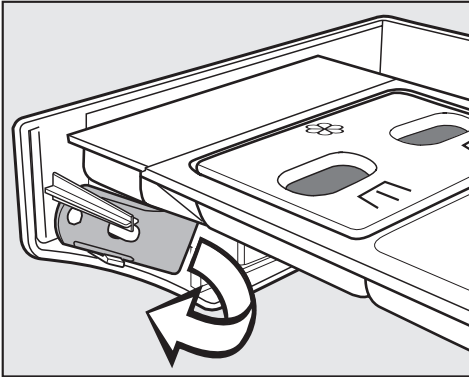

- Remove the tool.

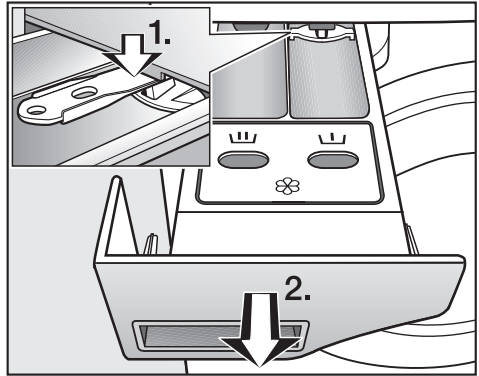

- Pull the detergent drawer out as far it will go.
- 1. Then press the safety catch down using the tool as illustrated.
- 2. Then pull the detergent drawer out.
- Clean the drawer with warm water.

Cleaning and care

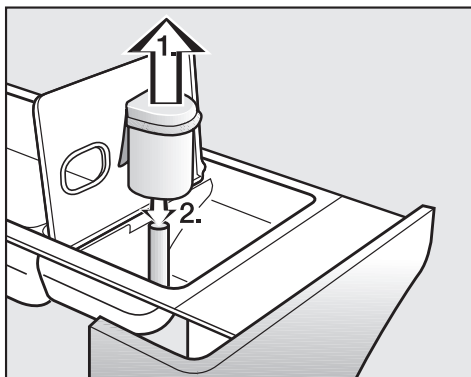

- Clean the siphon tube.

1. Remove the siphon from compartment  and rinse under warm running water. Clean the siphon tube in the same way.
2. Replace the siphon tube.

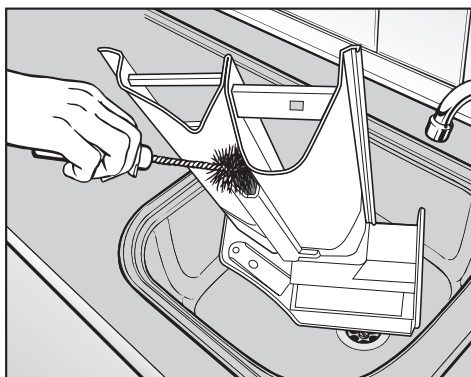

- Clean the fabric conditioner channel using a brush and warm water.

Clean the siphon tube and fabric softener channel more often when frequently using liquid starch. Liquid starch tends to stick.

Cleaning the niche of the detergent drawer

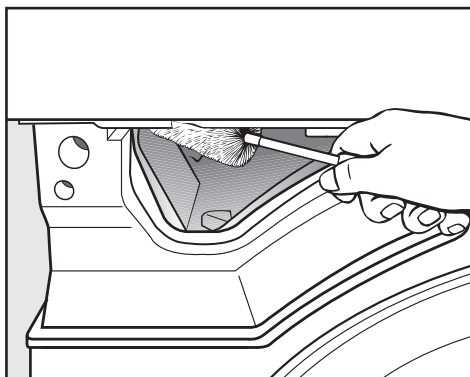

- Using a bottle brush remove any detergent or lime deposits from the water inlet valves at the top of the detergent drawer niche.

Cleaning the inlet hose filter

The washer has two water inlet filters to protect each inlet valve. Check and clean these filters every 6 months. This may have to be done more frequently with some water supplies.

Cleaning the inlet hose filters

- Turn off the water supply.
- Unscrew the inlet hose from the valve by turning the connector counterclockwise using a wrench if necessary.

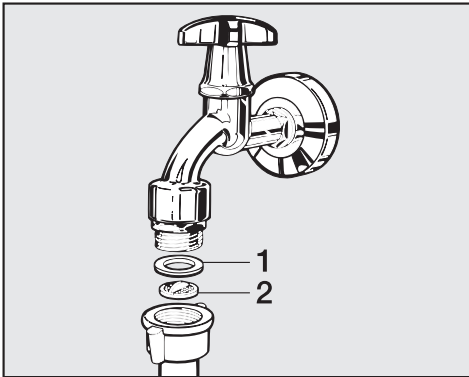

- Remove the rubber seal, **1**, from the connector.
- Using needle nose pliers, grasp the plastic filter, **2**, and pull it out of the hose connector.
- Clean the filter under running water and carefully remove any large particles.
- Replace the filter and seal and reconnect the hose.

Slowly turn on the water supply and check for leaks. If water leaks, tighten the hose connection.

To clean the filter in the water inlet valve:

- Using pliers, carefully loosen the ribbed plastic nut on the inlet valve and unscrew.

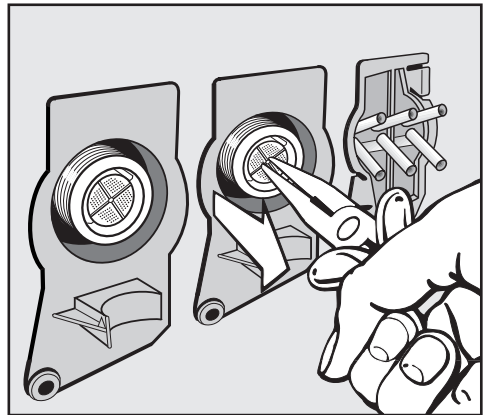

- Using needle nose pliers, remove the plastic filter by pulling on the bar (see illustration). Rinse under running water and return. Replace the filter and seal, then reconnect the hose.

Both filters **must** be put back in place after cleaning.





Frequently asked questions

 Repairs to electrical appliances must only be carried out by a qualified and trained person in accordance with local and national safety regulations. Repairs and other work by unqualified persons could be dangerous.

The following section will help you avoid placing a service call by identifying issues you may encounter while operating the machine:



The program does not start		
Problem	Possible cause	Solution
The display remains dark.	There is no power to the machine.	Possible fault: <ul style="list-style-type: none">– the washer is not connected to the electrical supply.– the circuit breaker has tripped.
The program does not start when "Spin" has been selected.	The machine has not been prepared for using for the first time.	Run the "Cottons Universal" program as described in the separate booklet "Commissioning the machine / Program chart / Settings".
The display is dark and the "Start" button is flashing slowly.	The machine goes into "Standby" mode. The display shuts off to save energy.	Press one of the direct select buttons. The machine comes out of standby mode.

Frequently asked questions

A fault message appears in the display		
Message	Possible cause	Solution *
 Water intake fault Open the water supply and check the intake hose.	The water intake is blocked or restricted.	Check whether <ul style="list-style-type: none"> – the water supply is opened enough. – the intake hose is kinked.
	The water pressure is too low.	<ul style="list-style-type: none"> – Select "Low water pressure" in the "Settings/Supervisor level" menu.
 Technical fault	There is a fault.	Re-start the program. If the fault message appears again, contact Miele.
 Fault Disinfection temperature not reached	During the disinfection program the water temperature was not reached.	The machine has not carried out the disinfection cycle correctly. Restart the program.
 Drain fault Clean the drainage system.	The water drainage is blocked or restricted.	LP version: Clean the drainage system. AV version: Contact Miele.
 Fill the container or Fault Container empty	One of the external detergent containers is empty.	See "Detergent - Empty sensor".

* To switch off the fault message, press the jog shuttle.

Frequently asked questions

General problems		
Problem	Possible cause	Solution
The machine shakes during the spin cycle.	The machine feet are not level.	Level the machine, see "Installation and connection".
The pump makes strange noises.	This is not a fault. These noises occur at the end of a pump sequence as a normal part of the operation.	
Large amounts of detergent residue remain in the detergent dispenser drawer.	The water pressure is too low.	<ul style="list-style-type: none"> – Clean the filters in the water inlets. – It may be useful to select the "Water plus" extra option.
	Powder detergent used in conjunction with water softeners tends to become sticky.	Add powder detergent into the dispenser drawer first, and then add the water softener.
Fabric softener is not completely dispensed or too much water remains in the  compartment.	The siphon tube is not correctly positioned or is clogged.	Clean the siphon tube, see "Cleaning and care - Cleaning the detergent dispenser drawer".
The display is in a different language.	A different language has been selected in "Settings  - Language  .	Set the language you want. The flag symbol will guide you.

Frequently asked questions

Poor wash results		
Problem	Possible cause	Solution
Liquid detergent does not give the required result.	Liquid detergents usually contain no bleaching agents. They do not remove fruit, coffee and tea stains.	<ul style="list-style-type: none"> – Use powder detergent containing bleach. (Be sure this is suitable according to the fabric care labels of the laundry.) – Fill powder bleach in compartment III and use a dispenser ball for the liquid detergent. – Never put liquid detergent and bleach together in the same wash compartment.
Grey, greasy particles cling to washed laundry.	<ul style="list-style-type: none"> – Not enough detergent was used to dissolve greasy deposits in heavily soiled laundry. – The laundry was soiled with grease (oils, lotions). 	<ul style="list-style-type: none"> – Use more detergent. – Before washing the next load run a Cottons 90°C program with powder detergent but without a load.
White residues which look like powder detergent are seen on dark textiles after washing.	The powder detergent was not completely dissolved because of hard water. These residues are difficult to remove.	<ul style="list-style-type: none"> – Try and brush off the residues with a soft brush once the laundry is dry. – Wash dark textiles using a detergent which contains no zeolites. Liquid detergents usually contain no zeolites.
Textiles have particularly greasy soiling.	<ul style="list-style-type: none"> – Add a Pre-wash to the program. Use liquid detergent for the pre-wash. <p>Use detergent which is specially formulated for heavily soiled work clothes. Contact the detergent manufacturer for more information.</p>	

Frequently asked questions

The door will not open	
Possible cause	Solution
The door is locked after a program has been canceled.	For safety reasons the drum door cannot be opened if the suds temperature is higher than 50°C. Wait until the machine has cooled down.
The door will not open at the end of a wash program.	Press against the door handle, turn the machine off and then back on again. Then pull on the door handle again.
There is still water in the drum and the machine is unable to drain.	The drainage system may be blocked. Clean the drainage system as described in the next section.
If you still cannot open the door:	The door handle has a safety device to prevent damage to the lock. Press firmly against the door handle until you clearly hear the safety device engage.

To continue a program after a power failure	
Possible cause	Solution
Power failure.	Confirm the message shown in the display by pressing direct select button <input type="checkbox"/> 1 <input type="checkbox"/> and then press the "Start" button. The program will then continue with the next program stage.
Turn the machine off and then back on again with the "On/Off" button.	

Opening the door during a power failure or when the drain is blocked

 Disconnect the machine from the power supply.

There is a tool behind the detergent drawer fascia panel which opens the access flap to the drain system.

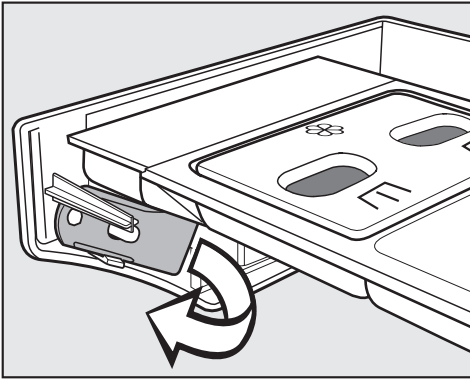

- Remove the tool.

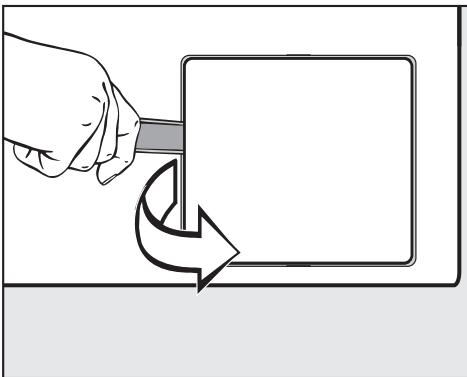

- Use it to open the lint trap door.

Drain the machine.

If the main drain hose is clogged, water will be retained in the machine (**up to 35 liters**).

 Caution: If laundry has been washed at a high temperature, the water draining out of the machine will still be hot! Stop and allow it to cool before proceeding.

Machines with a drain filter

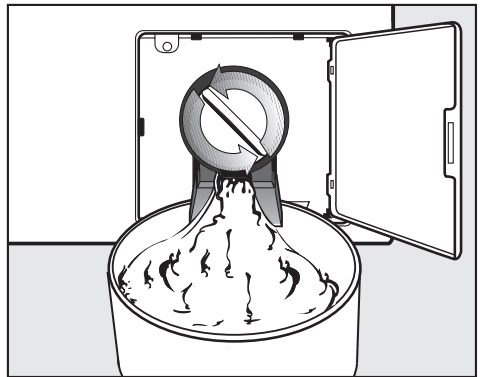

- Place a suitable container under the access flap.

When draining water from the machine, do **not** unscrew the drain filter completely or take it right out.

- Unscrew the lint trap lid until water runs out.

To stop the flow of water:

- Tighten the lid back up again.

Frequently asked questions

Once the flow of water stops:

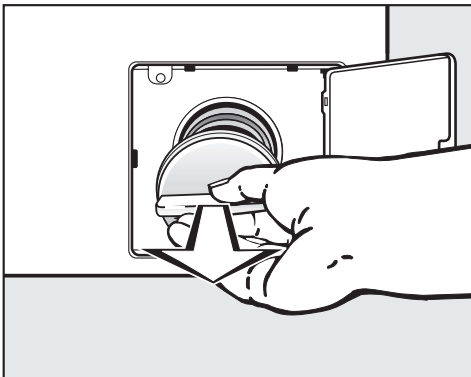

- Remove the lint trap lid completely.

Cleaning the drainage system

- Clean the lint trap thoroughly.

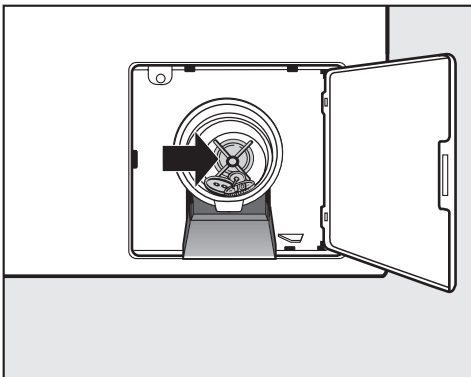

- Remove any foreign objects (e.g. buttons, coins, etc.) and fluff from the filter housing. Turn the impeller by hand to check that it rotates freely.
- Put the lid back in place and secure it.

 Make sure the lint trap is securely tightened. Otherwise there is a risk of water leakage during use.

Machines with a drain valve

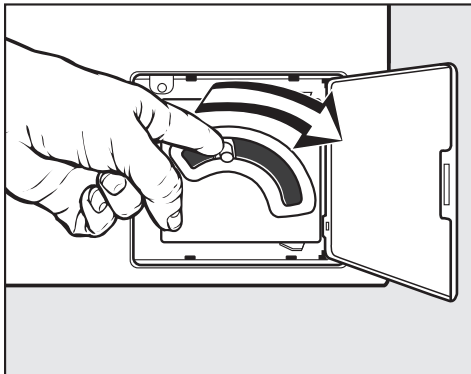

- Push the emergency drain lever downwards (see illustration) and hold until no more water runs out.

Opening the drum door

 Always make sure that the drum is stationary before reaching into the machine to remove laundry. Reaching into a moving drum is extremely dangerous.

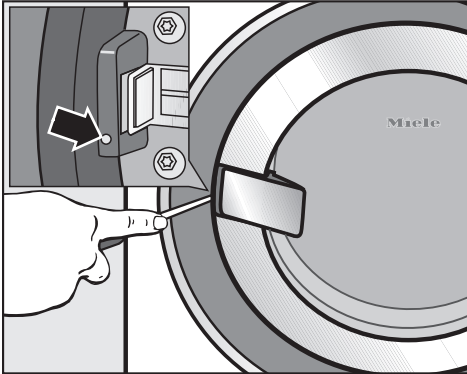

- Insert a suitable screwdriver (approx. 4 mm blade) into the opening next to the door lock and use it to release the catch. Turning it slightly in an anti-clockwise direction should release the door.
- Open the door with the handle.

 Do not force it open.

After sales service

Repairs

In the event of a fault which you cannot easily fix yourself, please contact technical service using the information on the back of this manual.

- Please quote the model and serial number of your appliance when contacting the Technical Service Department.

Both of which are shown on the data plate visible above the porthole glass when the drum door is open.

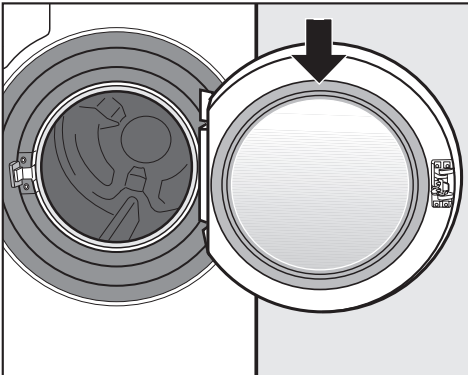

PC Update

The indicator marked PC allows a technician to make use of new technology. When, for example, new programs are developed or new fabrics are introduced, a service technician will be able to modify existing program cycles accordingly.

Miele will provide information when such possibilities become available.

Optional accessories

Optional accessories are available through your Miele dealer or Miele.

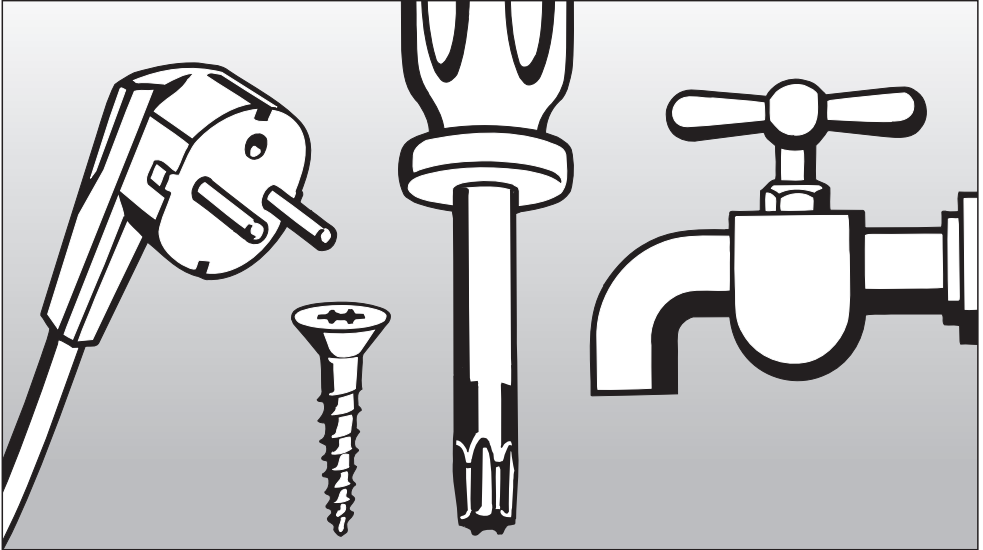

Installation Instructions

To prevent accidents
and machine damage
read these instructions
before
installation or use.

Installation

Front view

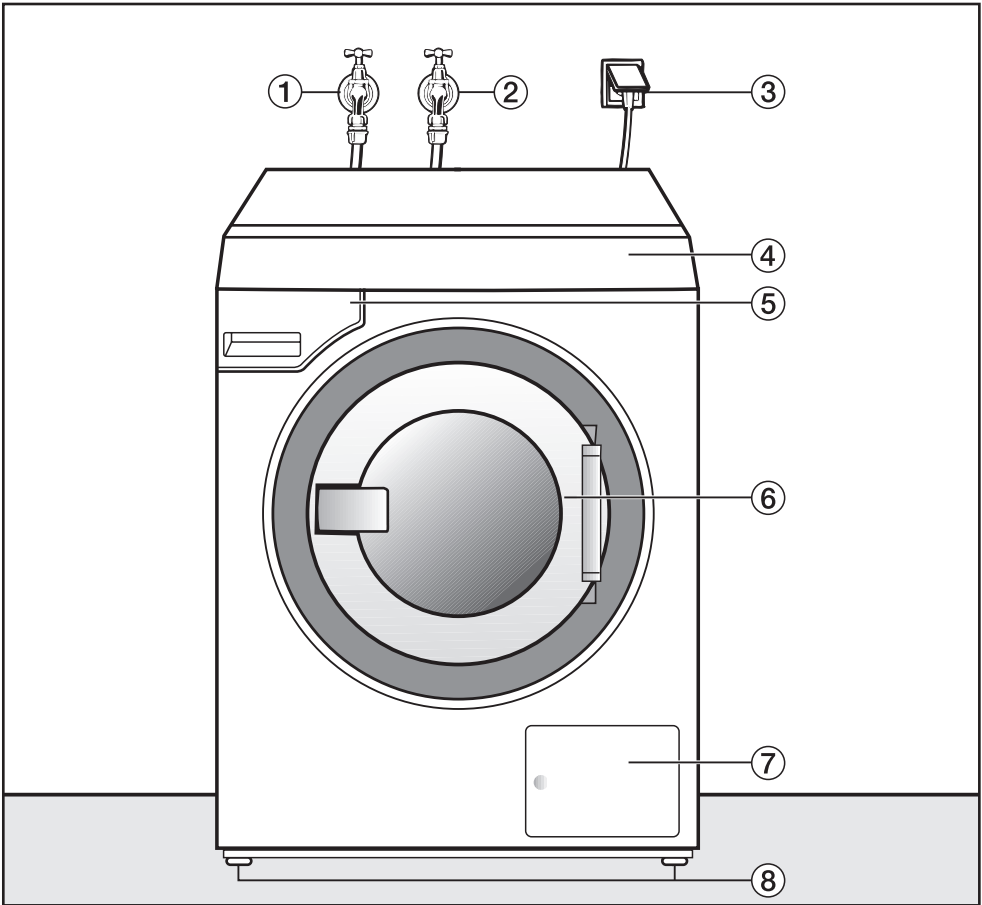

① Water intake hose (cold water)

② Water intake hose (hot water)

③ Power cord

④ Control panel

⑤ Detergent dispenser drawer

⑥ Drum door with handle

⑦ Access to drain filter, drain pump or drain valve and emergency door release

⑧ Height adjustable feet

Rear view

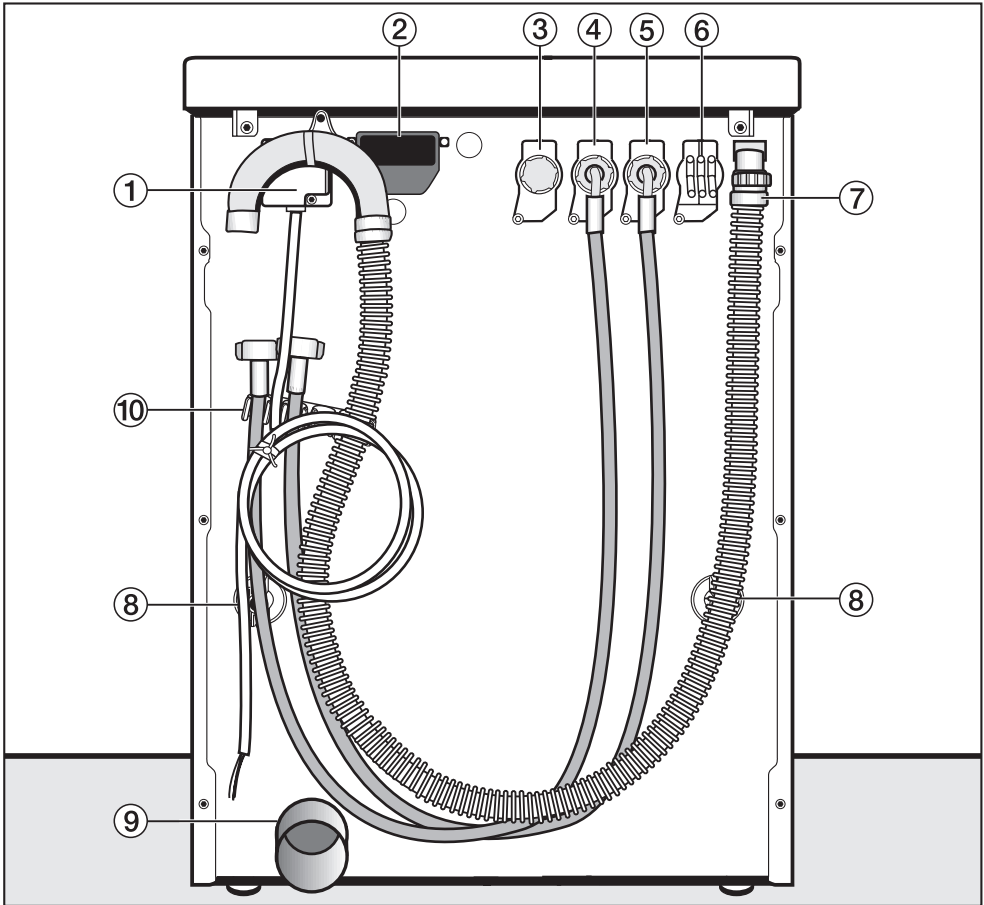

- ① Power cord
- ② W-LAN communication module
- ③ Valve for recycled water
- ④ Water intake hose (hot water)
- ⑤ Water intake hose (cold water)
- ⑥ Adapter for external dispensing system
- ⑦ Drain hose (for machines with drain pump)
- ⑧ Shipping struts
- ⑨ Drain pipe for machines with drain valve
- ⑩ Restraining clip for intake hose and drainage hose

Installation

Side view

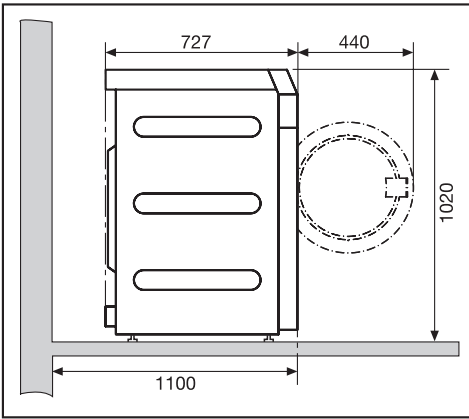

View from above

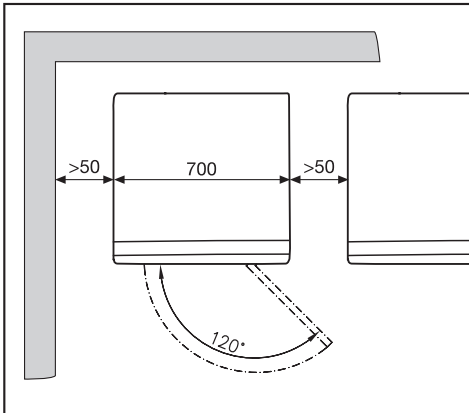

Installation

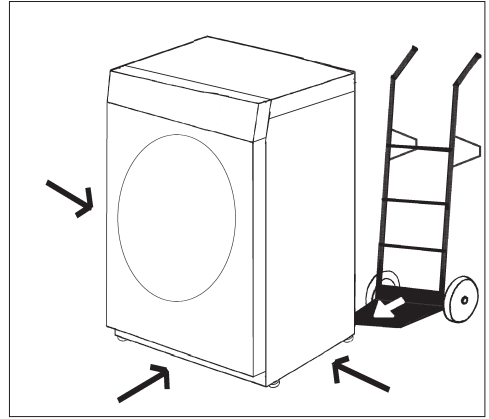

- Transport the machine to its installation site.

⚠ Ensure the machine is stable during transportation.

⚠ **Do not** lift the machine by the drum door.

⚠ Ensure that the machine's feet and the floor are dry to prevent slippage during the spin cycle.

The machine must be permanently connected to the electricity supply before the door can be opened. Do not install devices to automatically turn the washer off, i.e. a clock timer.

Installation site

The washer cannot be built-in.

 Do not install the machine directly next to or over an open floor drain or drain channel. Moisture can penetrate the machine and damage electrical parts.

A concrete floor is the most suitable surface for the washer. Concrete floors are less prone to vibration during the spin cycle than wooden floors.

- The machine must be leveled and securely positioned.
- To avoid vibration while spinning, the machine should **not be installed** on soft floor coverings.

In case the installation must be on a wooden joist floor:

- Install the unit on a $27 \frac{9}{16}$ " x $23 \frac{5}{8}$ " x $1 \frac{3}{16}$ " (70 x 60 x 3 cm) plywood base. Ideally the base should be large enough to span several joists and should be anchored to the joists and not just the floor boards.

It is best to install the washer in the corner of a room, where the stability of the floor is at its greatest.

Installation on a base

The machine can be installed on an open or closed steel base, or on a concrete base. Concrete is recommended.

 If the machine is installed on a concrete base, it must be secured using the clamps supplied with the machine. Otherwise there is a danger of the machine moving and falling off the base during spinning.

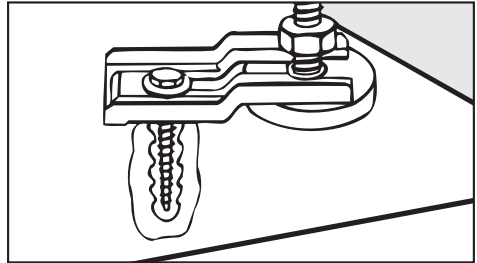

- Secure the two front feet of the washer with the supplied retaining clips when installing on a concrete base.
- Read the supplied Installation manual.

Installation

Coin mechanism

This machine can be fitted with a payment system.*

The payment system can be set up by the Miele technician or authorized dealer when the machine is commissioned.

Coins / tokens must be removed from the payment system regularly, otherwise it will become blocked.

* Available from Miele.

Removing the shipping struts

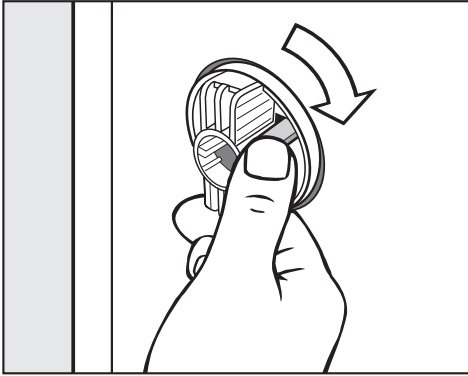

- Release the catch and turn the left hand shipping strut clockwise by 90°.

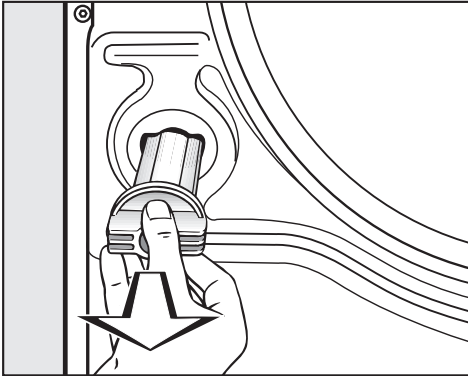

- Then withdraw the shipping strut
- Release the catch and turn the right hand shipping strut counter-clockwise 90°.
- Then remove the shipping strut.

⚠ The shipping strut holes must be covered after they have been removed. Otherwise there is a risk of injury.

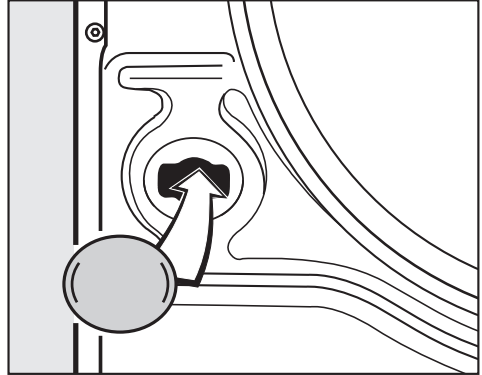

- Plug the holes with the plastic caps supplied.

⚠ Movement of the washer without the shipping struts in place should be kept to a minimum. The shipping struts should be stored on the back of the washer for future use. They must be reinstalled before moving the machine.

Re-fitting the shipping struts

Re-fit the struts by reversing the installation procedure.

Installation

Leveling the machine

To ensure smooth operation the washer must be level.

Failure to level the machine can result in increased water and energy consumption as well as the washer "banging" during the spin cycle or "walking" across the floor during use.

 The machine must stand perfectly level on all four feet to ensure safe and proper operation.

Adjust the four leveling feet

The washer is leveled by adjusting the four feet. The machine is boxed with the feet completely screwed in.

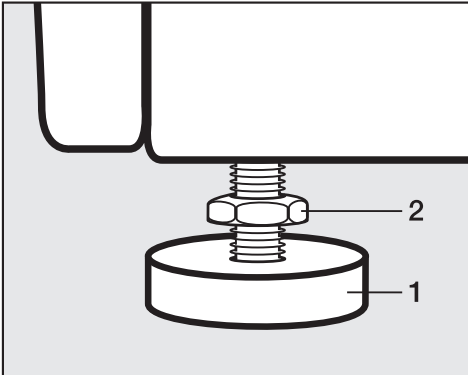

- Turn the locking nut, **2**, counter-clockwise with the enclosed combination wrench. Unscrew each of the four feet as much as necessary by turning both the foot, **1**, and the locking nut, **2**, to the left.

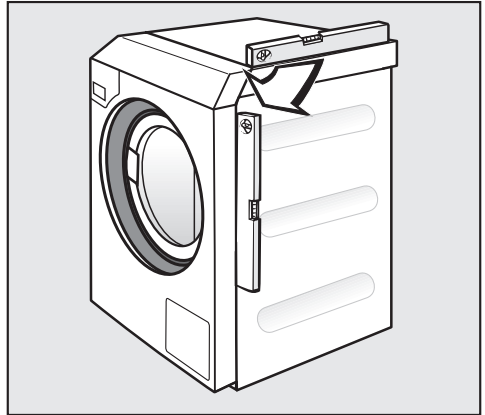

- Check that the machine stands level.
- Once level, hold the foot, **1**, steady with a wrench. Turn the locking nut, **2**, with the combination wrench towards the machine.

 All four locking nuts must be tight against the bottom of the machine. In addition, check to see that the feet were not inadvertently unscrewed while tightening the nuts. Running a machine that is not level or whose feet are not tight may cause damage to both the machine and its surrounding area.

Plumbing

Cold water connection

A water faucet with $\frac{3}{4}$ " threat must be provided on-site. If none is available the machine must be connected to a water line by a qualified plumber.

The water pressure must be between 14.5 -145 psi (1 -10 bar). If the water pressure is greater than 145 psi (10 bar), a pressure reducer must be installed. If the water pressure is below 15 psi (1 bar), there will not be enough water available for a complete fill.

The cold water hose (blue mark) is **not** suitable for a hot water connection.

- Connect the cold water intake hose (blue mark) to the cold water valve.
- Turn on the valve(s) and check for leaks.

The water intake hoses are equipped with screen filters. Do not remove these filters except for cleaning.

Maintenance

Replace the water hoses only with genuine Miele hoses.

Extension hoses

Extension hoses (8' 2" or 13' [2.5 m or 4 m]) may be obtained from Miele.

Installation

Hot water connection

Connecting the machine to a hot water supply will lead to low electrical consumption during hot water operation. The hot water temperature at the water supply must not exceed 158°F (70°C).

The water in single water lines from the hot water source cool faster when not in constant use. To heat the wash water more electricity must be used. The same conditions for the hot water as for the cold water connection will then apply.

- Connect the hot water intake hose (red mark) to the water supply.

The connection of the machine to a hot water line only, is not possible for functional reasons.

If the machine is not installed for hot water connection, the "Main wash water" setting must be set accordingly and the hot water inlet hose must be detached:

- Go to "Settings - Supervisor level - Main wash water" and select the "Cold" option.

The program times may be extended.

- Unscrew the hot water intake hose (red mark).
- Screw on the supplied stopper.

Recycled water connection

This machine can be connected to a recycled water supply.

- Unscrew the cap from the recycled water valve.
- Connect the additional inlet hose to this valve.

The "main wash" and "rinses" water settings must then be set as appropriate.

- Go to "Settings - Supervisor level" menu and select the "Recycled water" option.

Hot water supply

It is possible to connect the machine to a hot water supply, 158°F (70°C) to a maximum of 185°F (85°C). A special inlet hose is required for this option. The machine must also be reprogrammed by a Miele authorized service technician.

Drainage

There are two drainage extras for this machine:

Drain valve

The machine is drained with a motorized drain valve. A connection can be made to an on-site floor drain (gully with an air gap) on an angle.

Drain pump

The wash water is drained using a pump with a 3 ft (1 m) delivery height*. Make sure there are no kinks in the drain hose. The swivel elbow at the end of the hose can be turned in either direction, or can be detached if necessary, with a sharp twist and pull.

Drain hose connection:

1. Connected securely to a plastic drain pipe with a rubber nipple. There is no need to use a non-return valve.
2. Connected securely to a standpipe.
3. Connected securely to a floor gully.

If necessary the drain hose can be extended up to 16' 5" (5 m). The hose extension can be purchased from your Miele dealer or Miele.

The drain pump must be replaced for drain heights over 3 ft (1 m). The maximum allowable drain height is 5 ft 11 in (1.8 m). A stronger pump for these heights can be purchased from your Miele dealer or Miele.

Installation

Electrical connection

 This installation should be performed by an experienced and qualified technician, in accordance with local codes and regulations.

This machine is supplied with a connection cable without a plug for connection to a suitable connection socket or isolator switch.

 Before installation, make sure that the voltage and frequency listed on the data plate correspond with the site's electrical supply.

Connection to the electrical supply must only be carried out by a suitably qualified and competent person.

If the appliance is hard wired, a multiple-pole separator must be installed. Separators with a contact gap of more than 1/8" (3 mm) are valid as separators. All components have to bear CSA or UL approval.

The plug connection or the separator must be accessible at all times.

You must be able to lock the separator or monitor it at all times in case the appliance has to be disconnected from the power supply.

 If the machine is disconnected from the electrical supply ensure adequate measures are taken to ensure that the machine cannot be reconnected to the electrical supply until all work has been carried out.

Should the connection cable require replacing or changes be necessary in the electrical installation including checking and/or replacing the fuse please make sure this is done by an approved electrician to ensure compliance with all local and national electrical safety requirements.

For extra safety, it is advisable to protect the machine with a suitable residual current device (RCD) with a trip current of 30 mA.

 This machine must be connected to a permanent electricity supply so that the door can always be opened. For this reason it must not be connected to devices such as timers which would turn it off automatically.

**WARNING:
THIS APPLIANCE
MUST BE GROUNDED**

Technical data

Height	40 3/16" (1020 mm)
Width	27 9/16" (700 mm)
Depth	28 5/8" (727 mm)
Depth with door open	45 15/16" (1167 mm)
Weight	309 lbs (140 kg)
Max. load bearing in operation	2600 Newton (approx. 573 lb/260 kg)
Capacity	17.6 lbs (8 kg) dry laundry
Voltage	See data plate
Connected load	See data plate
Fuse rating	See data plate
Emission sound pressure level	< 70 dB (A)
Minimum water flow pressure	14.5 psi (1 bar)
Maximum water flow pressure	145 psi (10 bar)
Inlet hose length	5'1" (1.55 m)
Mains connection cable length	5'10 7/8" (1.80 m)
Drain pump head max. (drain pump version)	3' 3 3/8" (1.00 m)
Test certificates awarded	See data plate

Help protect our environment

Disposal of the packing material

The cardboard box and packing materials protect the appliance during shipping. They have been designed to be biodegradable and recyclable.

Ensure that any plastic wrappings, bags, etc. are disposed of safely and kept out of the reach of children, as they pose a danger of suffocation.

Disposal of an appliance

Old appliances may contain materials that can be recycled. Please contact your local recycling center about the possibility of recycling these materials.

Ensure that the appliance presents no danger to children while being stored for disposal. Before discarding an appliance, unplug it from the outlet, cut off its power cord and remove any doors to prevent hazards.

**Please have the model and serial number
of your appliance available before
contacting Technical Service.**



**U.S.A.
Miele, Inc.**

National Headquarters

9 Independence Way
Princeton, NJ 08540
Phone: 800-991-9380
609-419-9898
Fax: 609-419-4241
www.mieleusa.com

**Technical Service & Support
Nationwide**

Phone: 800-991-9380
Fax: 800-220-1348

proservice@mieleusa.com

Germany

Miele & Cie. KG
Carl-Miele-Straße 29
33332 Gütersloh