

# Operating and Installation Instructions

## Ventilation Hood

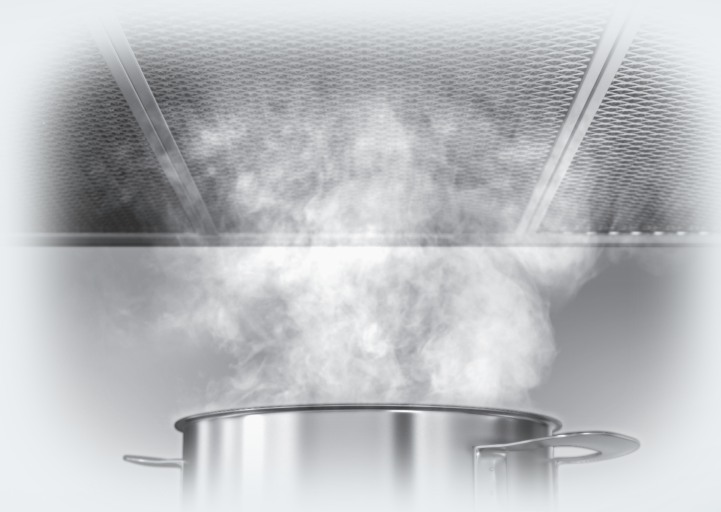

To prevent accidents and damage to the appliance, you **must** read these instructions before installing the appliance and using it for the first time.

# Contents

---

<b>IMPORTANT SAFETY INSTRUCTIONS</b> .....	4
<b>Caring for the environment</b> .....	13
<b>Guide to the appliance</b> .....	14
<b>Description of functions</b> .....	16
<b>Before using for the first time</b> .....	17
Selecting extraction mode or recirculation mode.....	17
Setting up Miele@home .....	17
Connecting via the app .....	18
Connecting via WPS .....	19
Signing out of WiFi (reset to factory settings) .....	20
Setting up Con@ctivity .....	21
Con@ctivity with direct wireless connection (Con@ctivity 2.0) .....	21
<b>Operation (Automatic mode)</b> .....	25
Cooking with Con@ctivity (Automatic mode) .....	25
Temporarily exiting Automatic mode .....	27
Resuming Automatic mode .....	27
<b>Operation (Manual mode)</b> .....	28
Cooking without Con@ctivity (Manual mode) .....	28
Turning on the blower.....	28
Selecting the power level .....	28
Selecting the delayed shutdown time .....	28
Turning off the blower.....	28
Dimming/switching the overhead lighting on/off.....	29
Power management .....	29
Safety shut-off.....	30
<b>Operation (Automatic and Manual modes)</b> .....	31
Filter saturation indicator.....	31
Adjusting the filter saturation indicator for the grease filters.....	31
Adjusting or deactivating the filter saturation indicator for the charcoal filter ..	32
Checking the filter saturation indicator.....	32
<b>Energy-saving tips</b> .....	33
<b>Cleaning and care</b> .....	34
Stainless steel housing.....	34
Grease filters .....	35

---

OdorFree Charcoal Filter .....	37
Resetting the filter saturation indicator for the charcoal filters.....	38
Disposing of charcoal filters .....	38
<b>Installation</b> .....	39
Before installation.....	39
Removing the protective film.....	39
Installation Instructions .....	39
Disassembly .....	39
Installation parts .....	40
Appliance dimensions .....	42
Distance between cooktop and ventilation hood (S).....	43
Installation recommendations .....	44
Drilling diagram for wall mounting.....	44
Plywood backing .....	45
To install a plywood backing .....	45
<b>Air venting</b> .....	46
Condensate trap.....	47
Reducing Collar .....	47
<b>Electrical connection</b> .....	48
<b>Service and warranty</b> .....	49
Location of the data plate .....	49
MieleCare .....	49
<b>Technical data</b> .....	50
Optional accessories for recirculation mode.....	50

# IMPORTANT SAFETY INSTRUCTIONS

---

## READ AND SAVE THESE INSTRUCTIONS

This appliance complies with current safety requirements. Improper use of the appliance can lead to personal injury and material damage.

Read all instructions before installing or using the appliance for the first time. Only use the appliance for its intended purpose.

Keep these operating instructions in a safe place and pass them on to any future user.

### **Appropriate use**

- ▶ **CAUTION:** For General Ventilating Use Only. Do Not Use To Exhaust Hazardous Or Explosive Materials And Vapors.
- ▶ This appliance is intended for residential use only. Use only as described in these operating instructions.
- ▶ This ventilation hood is not intended for outdoor use.
- ▶ It must only be used to extract and clean vapors produced during cooking. Any other use occurs at the owner's own risk.
- ▶ Where a recirculation ventilation hood is installed above a gas cooktop, please ensure that there is an adequate supply of fresh air into the room in which it is installed. Please seek the advice of a qualified gas fitter if necessary.
- ▶ This appliance is suitable for installation above gas or electric cooking surfaces.
- ▶ Persons who lack physical, sensory or mental abilities, or experience with the appliance should not use it without supervision or instruction by a responsible person.

# IMPORTANT SAFETY INSTRUCTIONS

---

## Safety with children

- ▶ As with any appliance, close supervision is necessary when used by children.
- ▶ Please supervise children in the vicinity of the hood and do not let them play with it.
- ▶ The LED ClearView lighting is very intense. Ensure that especially babies/small children don't look into the light.
- ▶ Danger of suffocation! Ensure that any plastic wrappings, bags, etc. are disposed of safely and kept out of the reach of children.

## Technical safety

- ▶ **WARNING: TO REDUCE THE RISK OF FIRE, ELECTRIC SHOCK, OR INJURY TO PERSONS, OBSERVE THE FOLLOWING:**
  - Use this appliance only in the manner intended by the manufacturer. If you have questions, contact Miele.
  - Before servicing or cleaning the appliance, switch power off at the service panel and lock the service disconnecting means to prevent power from being switched on accidentally. If the service disconnecting means cannot be locked, securely fasten a prominent warning device, such as a tag, to the service panel.
- ▶ Unauthorized installation, maintenance, and repairs can cause considerable danger for the user. Installation, maintenance, and repairs must only be carried out by a Miele authorized technician.
- ▶ A damaged ventilation hood can be dangerous. Always check for visible signs of damage. Never use a damaged ventilation hood.
- ▶ Be certain your appliance is properly installed and grounded by a qualified technician. To guarantee the electrical safety of this appliance, continuity must exist between the appliance and an effective grounding system. It is imperative that this basic safety requirement be met. If there is any doubt, have the electrical system of the house checked by a qualified electrician.

## IMPORTANT SAFETY INSTRUCTIONS

---

- ▶ Reliable and safe operation of this hood can only be guaranteed if it has been connected to the electrical supply.
- ▶ To avoid damaging the ventilation hood, make sure that the connection data (voltage and frequency) on the data plate correspond to the building's power supply before connecting the appliance.  
If in doubt, consult a qualified electrician.
- ▶ Do not use a power bar or extension cord to connect the ventilation hood to electricity. These are a fire hazard and do not guarantee the required level of appliance safety.
- ▶ To ensure safe operation, only use the ventilation hood after it has been properly installed.
- ▶ This ventilation hood may not be used in non-stationary locations (e.g. on a ship).
- ▶ Adequate ventilation must be provided when the hood is operated simultaneously with devices that burn gas or other fuels.
- ▶ Only open the housing as described in the enclosed "Installation diagram" and in the "Cleaning and care" section of this manual. Under no circumstances should any other parts of the housing be opened.  
Tampering with electrical connections or components and mechanical parts is highly dangerous to the user and can cause operation faults.
- ▶ Defective components should be replaced by Miele original parts only. Only with these parts can safety of the appliance be assured as intended by the manufacturer.
- ▶ If the power cord is damaged, it must only be replaced by a qualified service technician.

# IMPORTANT SAFETY INSTRUCTIONS

---

▶ During installation, maintenance, and repair work, the ventilation hood must be disconnected from the electrical supply. It is only completely isolated from the electricity supply if one of the following applies:

- The circuit breakers on the electrical service panel are tripped.
- The screw-type fuses on the electrical service panel have been removed.
- The power cord (if present) has been unplugged from the socket (pull the plug not the cord).

## **Correct use**

▶ **WARNING: TO REDUCE THE RISK OF A COOKTOP GREASE FIRE:**

- a) Never leave surface units unattended at high settings. Boilovers cause smoking and greasy spillovers may ignite. Heat oils slowly on low or medium settings.
- b) Always turn the hood on when cooking at a high heat.
- c) Clean the ventilation hood frequently. Grease should not be allowed to accumulate on the fan or filter.
- d) Use the proper pan size. Always use cookware appropriate for the size of the cooking area.

▶ Never use an open flame beneath the ventilation hood.

To avoid the risk of fire, do not flambé or grill over an open flame. When turned on, the ventilation hood will draw any flames into the filter. Fat deposits may ignite.

▶ **WARNING: TO REDUCE THE RISK OF INJURY TO PERSONS IN THE EVENT OF A COOKTOP GREASE FIRE, OBSERVE THE FOLLOWING\*:**

- a) **SMOTHER FLAMES** with a close fitting lid, cookie sheet, or metal tray then turn off the burner. **BE CAREFUL TO PREVENT BURNS.** If the flames do not go out immediately, **EVACUATE AND CALL THE FIRE DEPARTMENT.**

## IMPORTANT SAFETY INSTRUCTIONS

---

- b) NEVER PICK UP A FLAMING PAN - You may be burned.
- c) DO NOT USE WATER, including wet dishcloths or towels - a violent steam explosion will result.
- d) Use a fire extinguisher ONLY if:
  - 1) You have a class ABC extinguisher, and you know how to operate it.
  - 2) The fire is small and contained in the area where it started.
  - 3) The fire department is being called.
  - 4) You can fight the fire with your back to an exit.

\*Based on “Kitchen Fire Safety Tips” published by NFPA.

- ▶ The ventilation hood may become damaged if exposed to excessive heat from a gas cooktop.
  - When using the ventilation hood over a gas cooktop, ensure that any burners in use are always covered by cookware. Turn burners off when removing the cookware, even if doing so for just a short time.
  - Select cookware that is suitable for the size of the burner.
  - Adjust the flame so that it never extends up the sides of the cookware.
  - Avoid overheating the cookware (e.g., when cooking with a wok).
- ▶ Always turn the ventilation hood on whenever a burner is in use to prevent damage from condensation.
- ▶ Overheated oil and fat can ignite, causing fire damage to the ventilation system.

Do not leave cookware, pans, and deep fryers unattended when cooking with oil or fat. Similarly, never leave an open grill unattended when grilling.
- ▶ Fat and debris deposits impair the proper functioning of the ventilation hood.

To ensure that cooking vapors are properly cleaned, never use the ventilation hood without the grease filters in place.



## IMPORTANT SAFETY INSTRUCTIONS

---

- ▶ Please note that the heat rising from the stovetop during cooking can cause the ventilation hood to become very hot. Do not touch the housing or the grease filters until the ventilation hood has cooled down.

# IMPORTANT SAFETY INSTRUCTIONS

---

## Proper installation

- ▶ **WARNING: TO REDUCE THE RISK OF FIRE, ELECTRIC SHOCK, OR INJURY TO PERSONS, OBSERVE THE FOLLOWING:**
  - a) Installation work and electrical wiring must be done by qualified person(s) in accordance with all applicable codes and standards, including fire-rated construction.
  - b) Sufficient air is needed for combustion and exhausting of gases through the flue (chimney of fuel burning equipment to prevent back drafting. Follow the heating equipment manufacturer’s guideline and safety standards such as those published by the National Fire Protection Association (NFPA) and the American Society for Heating, Refrigeration and Air Conditioning Engineers (ASHRAE), and the local code authorities.
  - c) When cutting or drilling into the wall or ceiling, do not damage electrical wiring and other hidden utilities.
  - d) Ducted hoods must always be vented to the outdoors.
  - e) Do not use this hood with any solid-state speed control device.
- ▶ To determine whether a ventilation hood may be operated above your cooking appliance, please refer to the information provided by the appliance's manufacturer.
- ▶ Safety regulations prohibit the installation of a ventilation hood over solid fuel stoves.
- ▶ An insufficient safety distance between the cooktop and the ventilation hood can result in damage to the ventilation hood. The minimum safety distances between the top of the cooktop and the bottom of the ventilation hood given in the “Installation” section of this booklet must be observed, unless the cooktop manufacturer states that a greater safety distance is required. If more than one cooking appliance is installed beneath the ventilation hood, and they have different minimum safety distances to the ventilation hood, select the greater distance.

## IMPORTANT SAFETY INSTRUCTIONS

---

- ▶ Be sure to observe the information contained in the “Installation” section when mounting the ventilation hood.
- ▶ Metal parts can have sharp edges which may cause injury. Wear gloves to protect your hands from being cut.
- ▶ When installing the exhaust duct, only use pipes or tubes made of non-flammable material. These can be obtained from your Miele dealer or from Miele Technical Service.
- ▶ Exhaust air should not be vented into a chimney or vent flue which is otherwise in use and should not be channeled into ducting which ventilates rooms with fuel-burning installations.
- ▶ If exhaust air is to be extracted into a chimney or ventilation duct no longer used for other purposes, seek professional advice.
- ▶ **WARNING: TO REDUCE THE RISK OF FIRE USE ONLY METAL DUCTWORK.**

### **Cleaning and maintenance**

- ▶ There is a risk of fire if cleaning is not completed according to the instructions in this manual.
- ▶ Never use a steam cleaner to clean the ventilation hood. The steam can reach the electrical components and cause a short circuit.

### **Accessories**

- ▶ Use only genuine original Miele parts. If parts or accessories from other manufacturers are used, the warranty will become void.

# **IMPORTANT SAFETY INSTRUCTIONS**

---

## **FCC Declaration of Conformity**

▶ These devices comply with FCC Rules Part 15. This equipment has been tested and found to be in compliance with the limits for a Class B digital device, pursuant to Part 15 of the FCC Rules of Operation and is subject to the following conditions:  
These devices may not cause harmful interference.  
These devices must accept any interference received, including interference that may cause undesired operation.

## **FCC Radiation Exposure Statement**

▶ This equipment complies with FCC radiation exposure limits set forth for an uncontrolled environment. This equipment should be installed and operated with minimum distance 8" (20 cm) between the radiator and your body.

## **Industry Canada Statement**

▶ This digital apparatus does not exceed the Class B limits for Radio Noise Emissions from digital apparatus set out in the Radio Interference Regulations of the Canadian Department of Communications.

Complies with Canadian ICES-003 Class B specifications.

### Disposal of the packing material

The cardboard box and packing materials protect the appliance during shipping. They have been designed to be biodegradable and recyclable.

Ensure that any plastic wrappings, bags, etc. are disposed of safely and kept out of the reach of children.  
Danger of suffocation!

### Disposal of your old appliance

Electrical and electronic appliances contain valuable materials. They also contain certain substances, compounds and components which were essential for the proper functioning and safe use of the equipment. Handling these materials improperly by disposing of them in your household waste can be harmful to your health and the environment. Therefore, please do not dispose of your old appliance with regular household waste and follow local regulations on proper disposal.



Consult with local authorities, dealers or Miele in order to dispose of and recycle electrical and electronic appliances. Miele assumes no responsibility for deleting any personal data left on the appliance being disposed. Please ensure that your old appliance is kept away from children until removal. Observe safety requirements for appliances that may tip over or pose an entrapment hazard.

# Guide to the appliance

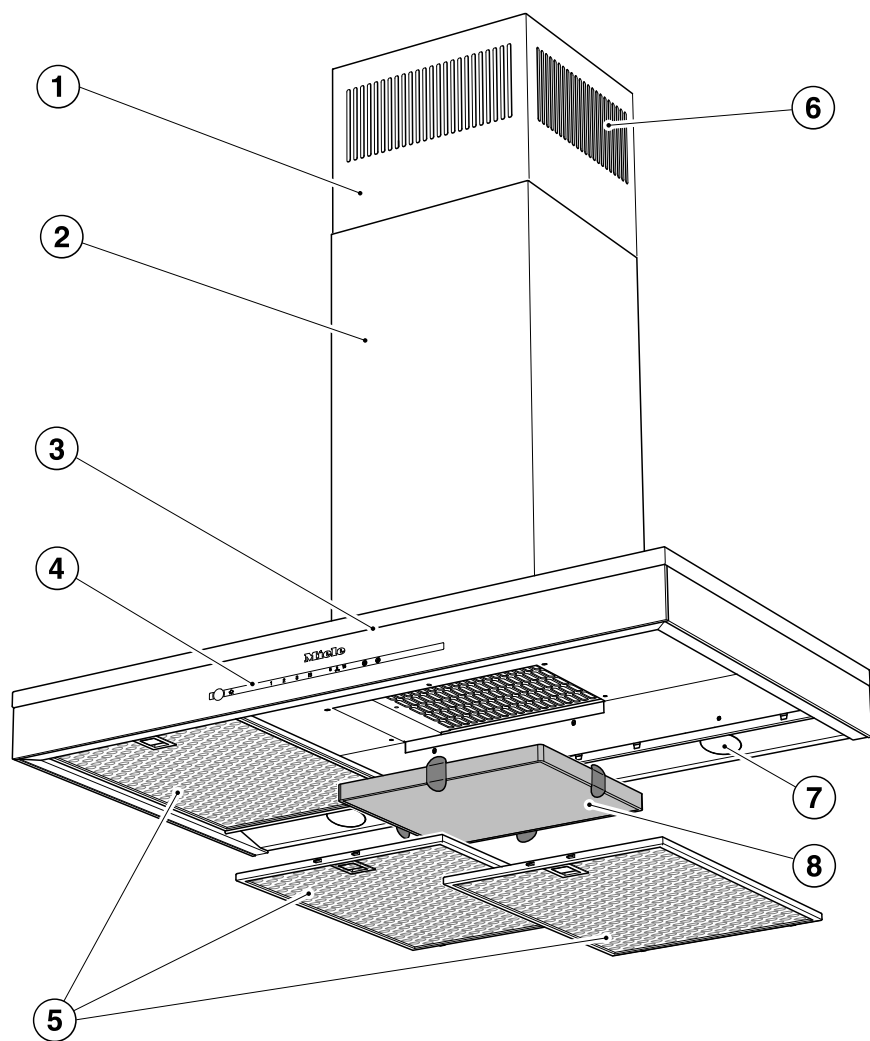

- ① Telescopic chimney
- ② Chimney
- ③ Canopy
- ④ Control panel
- ⑤ Grease filters
- ⑥ Recirculation vent  
(only for recirculation mode)
- ⑦ LED cooktop lighting
- ⑧ OdorFree Charcoal Filter  
Optional accessory for recirculation mode
- ⑨ Sensor control for turning the blower on and off
- ⑩ Sensor control for switching the lighting on and off and for dimming the lighting
- ⑪ Sensor controls for setting the blower power
- ⑫ Sensor control for delayed shutdown function
- ⑬ Sensor control for the grease filter saturation indicator
- ⑭ Sensor control for the charcoal filter saturation indicator  
The controls for the filter saturation indicator are used for displaying operating hours used and for altering the counter setting. See “Before using for the first time” for details on how to set the counter for extraction mode or for recirculation mode.

# Description of functions

The following functions are available on your ventilation hood, depending on the model:

## Extraction mode

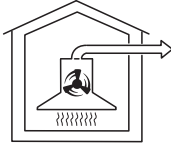

dell0494a

The air is drawn in and cleaned by the grease filters and directed outside.

## Non-return flap

A non-return flap in the ducting prevents the exchange of inside and outside air from occurring when the ventilation hood is not in use.

The flap is closed when the ventilation hood is turned off.

When the ventilation hood is turned on, the non-return flap opens so that the exhaust air can be transported outside without any obstruction.

A non-return flap has been provided with the hood in case your ducting does not have one. It is inserted into the outlet duct collar of the fan.

## Recirculation mode

The recirculation mode requires a recirculation kit and OdorFree Charcoal Filter (available as optional accessories, see “Technical Data” for more information)



dell0494b

The air is drawn in and first cleaned by the grease filters and then by an OdorFree Charcoal Filter. The cleaned air is then recirculated back into the kitchen.





# Before using for the first time

## Selecting extraction mode or recirculation mode

The ventilation hood can be operated with either extraction mode or recirculation mode. The power of the blower is adapted to suit the selected mode of operation. The ventilation hood is set up at the factory for recirculation mode. It has to be reset for extraction mode.

To reset it for extraction mode, the filter saturation indicator for the charcoal filter(s) has to be deactivated.

- Switch off the blower and the lighting.
- Touch the delayed shutdown control  and the charcoal filter control  at the same time.

The charcoal filter symbol  and one of the blower power level indicators will flash.

- Touch the **B** control.
- Confirm your choice by touching the charcoal filter control .

All the indicator lights will go out.

Extraction mode has now been set.

If the new setting is not confirmed within 4 minutes, the ventilation hood will revert to the previous setting.

## Setting up Miele@home

Requirement:

- Home WiFi network

Your ventilation hood is equipped with an integrated WiFi module. The ventilation hood can be connected to the household WiFi network.

You will then be able to operate the ventilation hood via the Miele@mobile app.

Before installing the ventilation hood in its final location, ensure that the signal of your WiFi network is strong enough.

Please note that you cannot set up a WiFi connection at the same time as a wireless connection (Con@activity 2.0, remote control).

## Miele@mobile App

The Miele@mobile App is available to download free of charge from the Apple App Store® or from the Google Play Store™.



# Before using for the first time

## Connecting via the app

The Miele@mobile app can be used to connect to your network.

- Install the Miele@mobile app on your mobile device.

To log in you will need:

1. Your WiFi network password
2. Your ventilation hood password



The password for your ventilation hood consists of the last nine digits of the serial number. This can be found on the appliance's data plate.

The data plate is visible once you have removed the grease filter.



- Start signing the appliance on in the app. Follow the signing in instructions.

If requested to activate WiFi on the ventilation hood, proceed as follows:

- Switch the ventilation hood off.

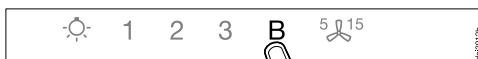

- Press and hold the **B** control.

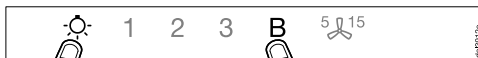

- Touch the lighting control  at the same time.

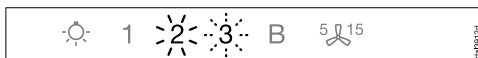

**2** will light up constantly, **3** will flash on and off.

The ventilation hood is ready for connection in the next two minutes.



- Follow the instructions in the app.

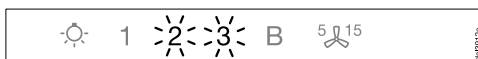

When successfully connected, **2** and **3** will light up constantly.



- Quit connection mode on the ventilation hood by touching the delayed shutdown control .

The ventilation hood can now be operated via the app.

# Before using for the first time

## Connecting via WPS

Your WiFi router must support WPS (WiFi Protected Setup).

- Switch the ventilation hood off.



- Press and hold the **B** control.

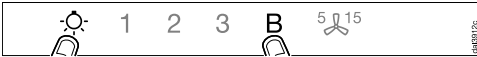

- Touch the lighting control  at the same time.

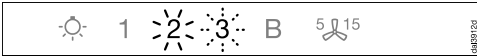

**2** will light up constantly, **3** will flash on and off.

The WiFi connection must be started on the ventilation hood at the same time as on the WiFi router.

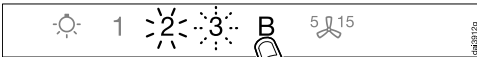

- Press the **B** control on the ventilation hood after a few seconds.

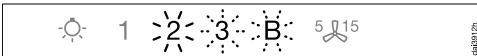

After a short while, **2** will light up constantly, and **3** and **B** will flash on and off.

The ventilation hood is ready for connection in the next two minutes.

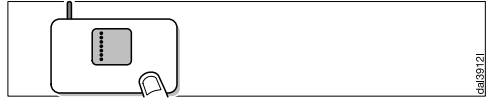

- Start the WiFi connection on your WiFi router.

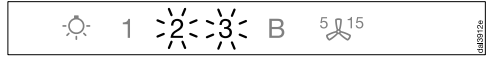

When successfully connected, **2** and **3** will light up constantly.



- Quit connection mode on the ventilation hood by touching the delayed shutdown control .

The ventilation hood can now be operated via the app.

If the connection fails, you have probably not connected WPS to your router quickly enough. Repeat the steps above.

**Tip:** If your WiFi router does not support WPS, please connect via the Miele@mobile app.

# Before using for the first time

## Signing out of WiFi (reset to factory settings)

To set up a new WiFi connection, the existing WiFi connection must be disconnected.

- Switch the ventilation hood off.



- Press and hold the 1 control.



- Touch the lighting control  at the same time.

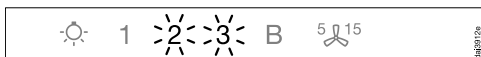

With an existing WiFi connection, **2** and **3** will light up constantly.

The ventilation hood is ready for disconnection during the next two minutes.



- Touch the **1** control.

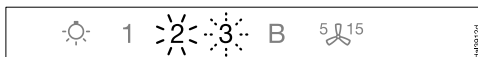

**2** will light up constantly, **3** will flash on and off.

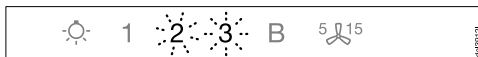

After a few seconds, **2** and **3** will flash on and off. The connection has now been disconnected.



- Quit disconnection mode on the ventilation hood by touching the delayed shutdown control  **5**.

The WiFi connection has now been disconnected. A new connection can now be set up.

# Before using for the first time

## Setting up Con@ctivity

Con@ctivity is the direct communication system between an induction Miele cooktop and a Miele ventilation hood. It enables the ventilation hood to operate automatically depending on the operational state of a Miele cooktop with onset controls.

- When a burner is turned on, the overhead lighting on the hood turns on automatically. After a brief delay, the ventilation hood blower also comes on.
- The ventilation hood selects the power setting automatically during cooking. The power level selected by the ventilation hood depends on the number of cooking zones being used and their power levels.
- After switching the cooktop off, the blower and the overhead lighting will switch off automatically after a specified period of time.

Detailed information about this function can be found under “Operation”.

## Con@ctivity with direct wireless connection (Con@ctivity 2.0)

Required:

- Con@ctivity 2.0 enabled Miele induction cooktop

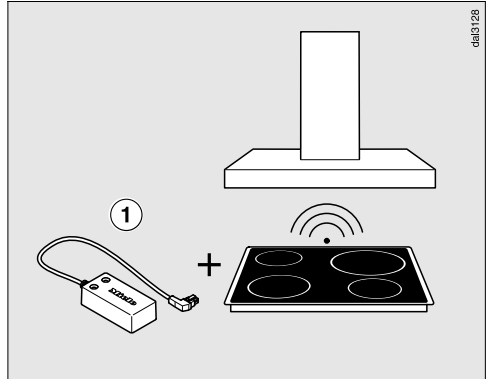

This ventilation hood is supplied with a Con@ctivity 2.0 wireless stick ①.

The wireless stick can only be used with cooktops that are fitted with a slot for the wireless stick to operate the Con@ctivity function.

- Check the installation instructions for the Con@ctivity 2.0 stick to ensure that it is compatible with your cooktop.

Please note that you cannot set up a WiFi connection at the same time as a wireless connection (Con@ctivity 2.0, remote control).

# Before using for the first time

## Installing the Con@ctivity 2.0 stick

- See the relevant installation instructions provided with the Con@ctivity 2.0 stick.

## Activating the wireless connection

The ventilation hood and the cooktop must be installed and operational.

The wireless connection must be activated on the ventilation hood and the cooktop at the same time. Activation on the ventilation hood is described below.

Activation on the cooktop is described in the relevant operating and installation instructions. Please refer to the operating instructions before starting. Activate the ventilation hood first, then the cooktop.

## Activating the ventilation hood

- The cooktop and ventilation hood must be switched off.



- Touch the delayed shutdown control  $5 \text{ fan } 15$  for approx. 10 seconds until **1** lights up.

- Then touch in turn:



- the **1** control,

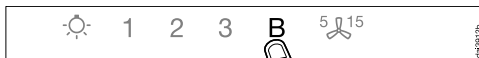

- then the **B** control,



- then the lighting control  $\text{lighting icon}$ .

The ventilation hood is now in signing on/off mode.

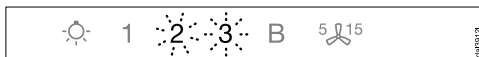

If a wireless connection has not yet been established, **2** and **3** will flash at the same time.

If a wireless connection has already been established, **2** and **3** will light up constantly (Con@ctivity 2.0 is already activated or a remote control is signed on).

## Before using for the first time



- Touch the **B** control to activate Con@ctivity 2.0.

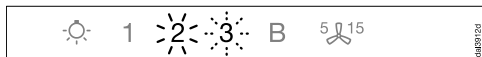

- **2** will light up constantly, **3** will flash on and off.

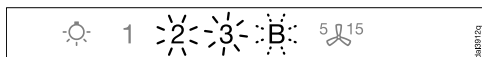

After a few seconds, **2** and **3** will light up constantly, **B** will flash on and off.

The search for a wireless connection will start.

### Activating the cooktop



- **While** the ventilation hood is searching for a signal, start activating the cooktop.  
For more details, see the cooktop operating instructions.
- When the cooktop registers that a connection has been established, exit activation on the cooktop.

### Finishing activation on the ventilation hood

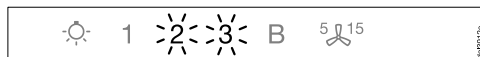

When successfully connected, **B** will go out, and **2** and **3** will light up constantly.



- Confirm activation with the delayed shutdown control **5 15**. All the indicator lights will go out.

The Con@ctivity function is now ready for use.

If you do not confirm within 4 minutes, activation will be canceled.

You only need to carry out the activation procedure once. If the appliances are disconnected from the electricity supply, for example during a loss of power, they will still remain activated.

# Before using for the first time

## Activation failed

If a wireless connection cannot be established despite activation of the Con@ctivity function on the ventilation hood and cooktop, the function must first be deactivated and then reactivated on both appliances.

## Deactivating the wireless connection

- The cooktop and ventilation hood must be switched off.



- Touch the delayed shutdown control  $5 \text{ } 15$  for approx. 10 seconds until **1** lights up.

- Then touch in turn:



- the **1** control,



- then the **B** control,



- then the lighting control  $\odot$ .

The ventilation hood is now in signing on/off mode.

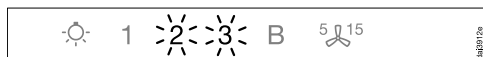

If a wireless connection has already been established, **2** and **3** will light up constantly.



- Touch the **1** control to deactivate Con@ctivity 2.0.

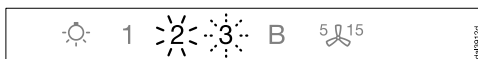

- 2** will light up constantly, **3** will flash on and off.

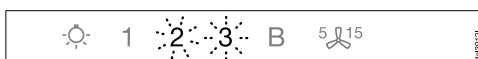

After a few seconds, **2** and **3** will start flashing on and off.

The wireless connection has now been deactivated.

- To deactivate the cooktop, please refer to the corresponding operating instructions.

Please bear in mind that disabling the connection will also disable any remote control function being used. The remote control must then be reactivated.



# Operation (Automatic mode)

When Con@ctivity is active, the ventilation hood always operates in Automatic mode (see “Setting up Con@ctivity”).

If you wish to manually operate the ventilation hood, see “Cooking without Con@ctivity”.

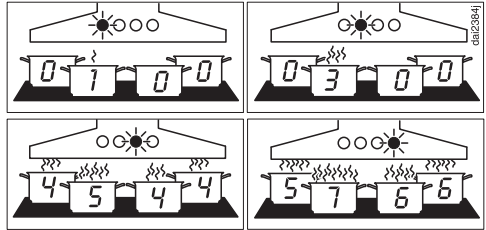

Examples for power levels 1 to B

## Cooking with Con@ctivity (Automatic mode)

- Turn on a burner to the desired power setting.

The overhead lighting will come on.

After a few seconds, the blower will come on, briefly operating at power level 2 before immediately switching to level 1.

The ventilation hood selects the power setting automatically during cooking.

This level is determined by the total output of the cooktop, i.e., the number of burners in operation and the power settings selected.

- If you select a higher power setting on the cooktop or switch on multiple burners, the hood will switch to a higher blower level.
- If you select a lower power setting on the cooktop or turn off a burner, the hood will accordingly switch to a lower blower level.

## Reaction time

Changing the power setting on the cooktop does not lead to an immediate increase or decrease in cooking vapors. For this reason, the hood reacts with a slight delay.

Delays can also result from the fact that the cooktop transmits the information to the hood in intervals.

The reaction time can vary from a few seconds to a couple of minutes.

# Operation (Automatic mode)

---

## Cooking process

- If, for example, you switch on a burner at the highest power setting to heat cookware in preparation for searing and then reduce the power level after approx. 10 seconds to 4 minutes, a cooking process is recognized.

The hood turns on automatically and, after the cooktop power level has been reduced, switches back to blower level 3, where it remains for approx. 5 minutes.

After this, the blower level is once again determined by the Con@ctivity function.

- You can also manually select a different blower level before then.

## Switching off

- Turn off all burners.

Over the next few minutes, the ventilation hood blower setting will decrease one level at a time until the hood eventually turns off.

This helps to neutralize any lingering vapors and odors in the air.

- From the Booster setting, the blower switches immediately to level 3.
- From level 3, it will switch to level 2 after approx. 1 minute.
- From level 2, it will switch to level 1 after 2 minutes.
- After 2 minutes at level 1, the blower automatically turns off.
- After another 30 seconds, the overhead lighting turns off.

The cooking process is then finished.

### Temporarily exiting Automatic mode

To temporarily exit Automatic mode when cooking:

- Manually select a different blower level, or
- Manually turn the hood off, or
- Activate the delayed shutdown function  on the ventilation hood. The blower will switch itself off after the selected delayed shutdown time, and the lighting will remain on.

The ventilation hood functions can now be operated manually (see “Cooking without Con@ctivity”).

### Resuming Automatic mode

The ventilation hood resumes Automatic mode:

- If the ventilation hood has not been used for a period of approx. 5 minutes after the manual selection of a blower level, or
- If the manually selected blower level once again matches the automatic setting, or
- The ventilation hood blower and the cooktop have been switched off for at least 30 seconds. Automatic mode will resume next time the cooktop is switched on.

You can also operate the ventilation hood manually for a complete cooking process.

- To do so, switch the ventilation hood blower on **before** the cooktop. If the ventilation hood and the cooktop have been switched off for at least 30 seconds after cooking, Automatic mode will resume next time the cooktop is switched on.

# Operation (Manual mode)

---

## Cooking without Con@ctivity (Manual mode)

The ventilation hood can be operated manually if:

- The Con@ctivity function is not activated.
- You have temporarily deactivated the Con@ctivity function (see “Temporarily exiting Automatic mode”).

## Turning on the blower

Switch the blower on as soon as you start cooking. This is to ensure that vapors are captured right from the start.

- Touch the On/Off control .

The blower switches on at power level **2**.

## Selecting the power level

Power levels **1** to **3** are available for light to heavy cooking vapors and odors.

For strong vapors and odors that are temporarily produced when cooking, e.g., during searing, select the **B** booster level.

- Select the power level required by tapping a button from **1** to **B**.

## Reducing power down from the Booster setting





If power management is activated (default setting), the blower automatically switches back to level **3** after 5 minutes.

## Selecting the delayed shutdown time

It is advisable to run the blower for a few minutes after cooking has finished. This helps to neutralize any lingering vapors and odors in the air.

It also reduces the risk of residues accumulating in the ventilation hood and any resultant odors.

The delayed shutdown function enables the blower to continue running for a pre-determined time before switching itself off automatically.

- After you have finished cooking, touch the delayed shutdown control .
- Once: blower switches off after 5 minutes (**5**  lights up).
- Twice: blower switches off after 15 minutes ( **15** lights up).
- If you touch the delayed shutdown control  again, the blower will remain switched on ( will go out).

## Turning off the blower



- Press the On/Off control  to turn the blower off.

### Dimming/switching the overhead lighting on/off

The overhead lighting can be switched on and off and dimmed independently of the blower.

- Touch the lighting control  briefly to switch it on or off.

The lighting will switch on at maximum brightness.

- With the lighting switched on, press and hold the lighting control . The brightness will gradually dim until you release the control.
- To increase the brightness, press and hold the lighting control  again until the desired level has been reached and then release it.

### Power management

The ventilation hood features a power management system to help save energy. The blower power level is reduced and the lighting is turned off automatically.

- If the booster level is selected, the blower automatically switches to level 3 after 5 minutes.
- If the blower is set to level 3, 2 or 1, it switches back one blower setting after 2 hours and then in 30-minute intervals until the blower eventually switches off.
- If the overhead lighting is on, it will switch off automatically after 12 hours.



You can deactivate power management.

This can, however, result in increased energy consumption.

# Operation (Manual mode)

---

## Turning power management on/off

- Switch off the blower and the lighting.
- Touch the delayed shutdown control  for approx. 10 seconds, until **1** lights up in the power level display.
- Then touch in order:
  - the lighting control ,
  - the **1** control, and then
  - the lighting control .

If power management is turned on, the **1** and **B** indicators will be continuously lit.

If it is turned off, the **1** and **B** indicators will flash.

- Touch the **1** control to turn power management off.

The **1** and **B** indicators will flash.

- Touch the **B** control to switch it on.

The **1** and **B** indicators will be continuously lit.



- Confirm the setting by pressing the delayed shutdown control .

All the indicator lights will go out.

If the new setting is not confirmed within 4 minutes, the ventilation hood will revert to the previous setting.

## Safety shut-off



If power management has been deactivated, the ventilation hood will switch itself off automatically after 12 hours if it has been left on (blower and overhead lighting).

- To switch it back on, press the On/Off  control or the lighting control .

# Operation (Automatic and Manual modes)

## Filter saturation indicator

The ventilation hood registers the length of time it has been operated.



The filter saturation indicators show when the filters need to be cleaned or changed by lighting up the grease filter symbol  or charcoal filter symbol . Additional information on cleaning and changing the filters and resetting the filter saturation indicators can be found under “Cleaning and care”.

## Adjusting the filter saturation indicator for the grease filters

You can set the filter saturation indicator to suit your cooking habits.

The factory default setting is a cleaning interval of 30 hours.

- Select a shorter interval of 20 hours if you fry food regularly.
- We also recommend a shorter cleaning interval if you only cook occasionally. This will prevent grease build-up from hardening and making cleaning more difficult.
- Select a longer cleaning interval of 40 or 50 hours if you use very little fat when cooking.

- Switch off the blower and the lighting.
- Touch the delayed shutdown control <sup>5</sup> and the grease filter control  at the same time.

The grease filter symbol  and one of the blower power level indicators will flash.

The indicators **1** to **B** show the current time setting:

<b>1</b> .....	20 hours
<b>2</b> .....	30 hours
<b>3</b> .....	40 hours
<b>B</b> .....	50 hours

- Touch the relevant control to select the duration required.
- Confirm your choice by touching the grease filter control .

All the indicator lights will go out.

If the new setting is not confirmed within 4 minutes, the ventilation hood will revert to the previous setting.

## Operation (Automatic and Manual modes)



### Adjusting or deactivating the filter saturation indicator for the charcoal filter

The charcoal filter is needed for recirculation mode.

You can set the filter saturation indicator to suit your cooking habits.

It has to be deactivated for extraction mode.

It is set at the factory for 180 hours of use before it needs to be replaced.

- Switch off the blower and the lighting.
- Touch the delayed shutdown control  and the charcoal filter control  at the same time.

The charcoal filter symbol  and one of the blower power level indicators will flash.

The indicators **1** to **B** show the current time setting:

- 1**..... 120 hours
- 2**..... 180 hours
- 3**..... 240 hours
- B**..... Deactivated



- Touch the relevant control to select the duration required.
- Confirm your choice by touching the charcoal filter control .

All the indicator lights will go out.

If the new setting is not confirmed within 4 minutes, the ventilation hood will revert to the previous setting.

### Checking the filter saturation indicator

Before the set operating time has run out, you can check what percentage of the time has elapsed.

- Press the On/Off control  to turn the blower on.
- Press and hold the grease filter control  or the charcoal filter control .

One or more of the power level indicators will flash.

The number of flashing indicators shows the elapsed operating time as a percentage.

- 1** ..... 25 %
- 1 and 2** ..... 50 %
- 1 to 3** ..... 75 %
- 1 to B** ..... 100 %

The elapsed operating time remains stored in the memory when the ventilation hood is turned off or in the event of an interruption to the power supply.



This hood operates in a very efficient and energy-saving manner. The following will help you to save even more energy when using it:

- Ensure that there is sufficient ventilation in the kitchen when cooking. If there is insufficient air flow during extraction mode, the hood cannot operate efficiently, causing increased operating noise levels.
- Always cook with the lowest possible setting. This produces fewer cooking vapors so that you can use a lower hood power level and therefore benefit from reduced energy consumption.
- Clean or change the filters at regular intervals. Heavily soiled filters reduce performance, increase the risk of fire and are unhygienic.
- Use the Con@ctivity function. The ventilation hood will switch on and off automatically at the optimum power level for the cooking you are doing, which ensures low energy consumption.
- If you are operating the ventilation hood manually, please note the following:
  - Check the power level selected on the ventilation hood. A low power level is usually sufficient. Only use the Booster setting when necessary.
  - When a large volume of cooking vapors are being produced, switch to a high power level in good time. This is more efficient than operating the hood for longer to try to capture cooking vapors that have already been distributed throughout the kitchen.
  - Make sure that you switch off the hood after use. If cooking vapors and odors still need to be removed from the kitchen air after cooking, use the delayed shutdown function. The blower will switch off automatically after the selected delayed shutdown time.

# Cleaning and care

---

 **WARNING: TO REDUCE THE RISK OF FIRE, ELECTRIC SHOCK, OR INJURY TO PERSONS, OBSERVE THE FOLLOWING:**

- Before cleaning or servicing the hood, disconnect it from the power supply, see “IMPORTANT SAFETY INSTRUCTIONS”.

## Stainless steel housing

### General information

 The surfaces and control buttons are susceptible to scratching and chipping. Observe the following cleaning instructions.

- Clean all surfaces and control buttons using warm water and liquid dish soap. Apply with a sponge cloth.
- After cleaning, dry the surfaces with a soft cloth.

Avoid the following:

- Cleaners containing soda, acid or chloride, or cleaners containing solvents
- Abrasive cleaners such as scouring powder, scouring liquid, abrasive sponges such as pot scourers, or used sponges that still contain residues from abrasive cleaners

### Special instructions for stainless steel surfaces

- Stainless steel surfaces can also be cleaned using a non-abrasive stainless steel cleaner.
- To prevent the surfaces from quickly becoming dirty again, we recommend treating them with a stainless steel care conditioner.  
Apply sparingly over the entire area using a soft cloth.

### Special instructions for RAL color finish housings

- Observe the general cleaning instructions contained in this chapter.

Minor scratches on the surface are inevitable when cleaning the housing. Depending on the lighting in the kitchen, this may negatively affect the appliance's appearance.

### Special instructions for glass surfaces

- Glass surfaces can be cleaned using a cleaner specifically for use on glass.

## Grease filters



Risk of fire!

Oversaturated grease filters are a fire hazard.

Clean the grease filters at regular intervals.

The reusable metal grease filters in the appliance remove the solid particles contained in kitchen vapors (grease, dust, etc.), thereby preventing the ventilation hood from becoming dirty.

The grease filters must be cleaned at regular intervals.

Heavily soiled grease filters hinder air extraction and will lead to increased levels of soiling in the ventilation hood and in the kitchen.

## Cleaning intervals

Accumulated grease solidifies over a longer period of time and makes cleaning more difficult. The grease filters should therefore be cleaned every 3 to 4 weeks.

The filter saturation indicator reminds you to regularly clean the grease filters by illuminating the grease filter symbol .

- You can adjust the interval for the filter saturation indicator to match your cooking habits (see “Operation”).

## Removing the grease filters



When handling the grease filter, be careful not to drop it.

This can result in damage to the filter and the cooktop below.

Make sure you hold the filter securely at all times when handling it.

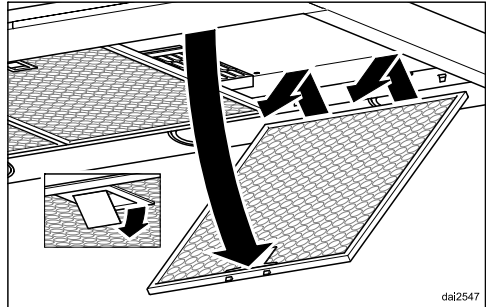

- To remove a grease filter, release the locking clip. Then, open the filter to a 45° angle, unhook it, and remove it from the hood.

## Cleaning the grease filters by hand

- Clean the filters with a soft nylon brush in a mild solution of hot water and dish soap. Do not use undiluted dish soap.

# Cleaning and care

## Unsuitable cleaning agents

Unsuitable cleaners can cause damage to the filter surfaces if used regularly. Do not use any of the following:

- Lime removers
- Abrasive powders or abrasive liquids
- Aggressive all-purpose cleaners and degreaser sprays
- Oven sprays

## Cleaning the grease filters in a dishwasher

- Place the grease filters upright or slightly inclined in the lower basket. Ensure the spray arm is not obstructed.
- Use a commonly available household dishwashing detergent.
- In a Miele dishwasher use the “Normal” program.

Depending on the detergent used, cleaning the filters in a dishwasher may cause the inside filter surfaces to become discolored. However, this will not affect the functioning of the grease filters in any way.

## After cleaning

- After cleaning, leave the filters on an absorbent surface to dry.
- When removing the filters for cleaning, also clean off any accessible oil or fat buildup from the housing. Doing so will prevent a fire hazard.
- Reinstall the grease filters. When inserting the filters, make sure that the locking clip is facing down.

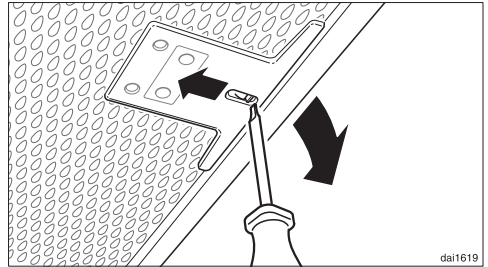

- If the filters have been installed incorrectly, you can insert a small screwdriver into the slit to disengage the locking clip.

## Resetting the filter saturation indicator for the grease filters

Once cleaning is complete, the filter saturation indicator must be reset.

- While the blower is turned on, touch the grease filter control  for approx. 3 seconds, until only the **1** is flashing.

The grease filter symbol  goes out.

When cleaning the grease filters before the full operating time has elapsed:

- Touch the grease filter control  for approx. 6 seconds, until only the **1** is flashing.

## OdorFree Charcoal Filter

With recirculation mode, a charcoal filter must be fitted in addition to the grease filters. The charcoal filter is designed to absorb cooking odors.

The charcoal filter is fitted in the canopy above the grease filters.

### How to install/replace a charcoal filter

- Remove the grease filters before fitting or replacing a charcoal filter.
- Take the charcoal filter out of its packaging.

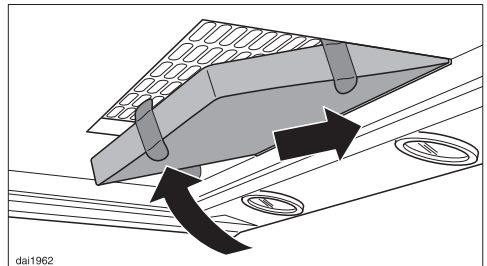

- Slide the filter into the back of the intake frame, then push the front of the filter up into the frame.
- Reinsert the grease filters.

# Cleaning and care

---

## When to change the OdorFree Charcoal Filter

- Replace the charcoal filter when it no longer absorbs kitchen odors effectively.  
It should be replaced at least every 6 months.

The filter saturation indicator reminds you to regularly clean the charcoal filter by illuminating the charcoal filter symbol .

## Resetting the filter saturation indicator for the charcoal filters

After changing the charcoal filters, the filter saturation indicator must be reset.

- Touch the charcoal filter control  for approx. 3 seconds with the blower switched on until only the indicator light for level **1** is flashing.

The charcoal filter symbol  will go out.

If you want to replace the charcoal filter **before** the full operating time elapses:

- Touch the charcoal filter control  for approx. 6 seconds until only the indicator light for level **1** is flashing.

## Disposing of charcoal filters

- The used charcoal filter can be disposed of with the normal household waste.

Charcoal filters are available to order via the Miele Web Store (see end of this booklet for contact details), or from your Miele dealer.

The charcoal filters are listed under “Technical data” at the back of this booklet.

## Before installation

 Before installing the appliance, read all of the information contained in this chapter and also in the “IMPORTANT SAFETY INSTRUCTIONS” section.

## Removing the protective film

The housing components are covered by a protective film to prevent them from damage during transport.

- Please remove this film before installing the housing components. It can be peeled off easily without any additional tools.

## Installation Instructions

Please refer to the accompanying installation sheet for instructions on how to install the appliance.

Leave these instructions with the appliance for the consumer/user.

Information is subject to change. Please refer to our website to obtain the most current product specification, technical & warranty information.

## Disassembly

If the device ever needs to be disassembled, follow the installation sheet instructions in reverse order. A lever is provided to assist with the removal of the chimney.

- Unscrew the two mounting screws on the chimney.

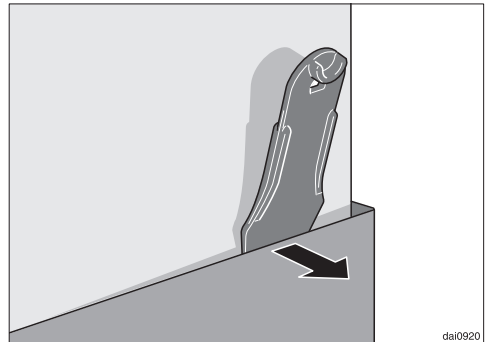

- Slide the supplied lever between the chimney and the extension piece.
- Pry the chimney out of its attachment.

# Installation

## Installation parts

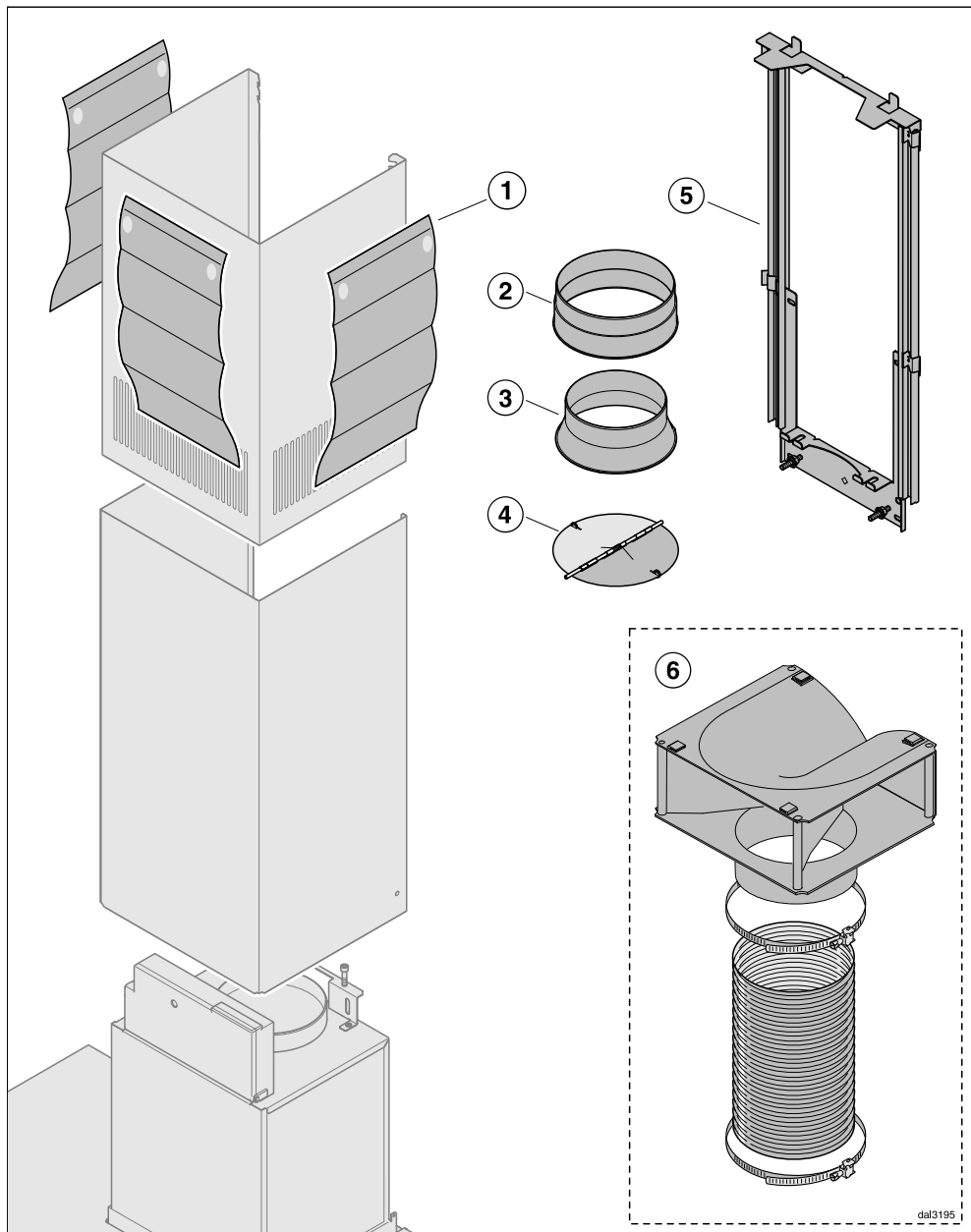



① **3 protective installation sheets**  
for use when installing the chimney.

② **1 collar**  
for exhaust ducting  $\varnothing$  6" (150 mm).

③ **1 reducing collar**  
for exhaust ducting  $\varnothing$  5" (125 mm).

④ **1 non-return flap**  
for fitting into the exhaust socket on the motor unit (not needed for recirculation mode). Depending on the model, the non-return flap may already be mounted.

⑤ **Telescopic wall bracket**  
for securing the ventilation system on the wall.

⑥ **Conversion kit for recirculation mode**  
contains a directional unit socket and flexible aluminum hose with hose clips (not supplied, available as an optional accessory, see "Technical data").



560900010008050

**6 screws  $3/16"$  x  $2 3/8"$  (5 x 60 mm)**  
and  
**6 plugs  $5/16"$  x 2" (8 x 50 mm)**  
for securing the ventilation system on the wall.

⚠ The screws and plugs are designed for use in solid walls only. Use different fasteners for other wall construction types. Make sure that the wall can support the load.



00031682

**2 M6 locknuts**  
for mounting the appliance unit.



06256130

**2  $1/8"$  x  $5/16"$  (3.9 x 7.5 mm) screws**  
for attaching the chimney.

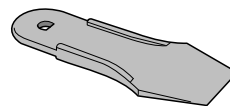

00033716

**1 lever**  
for disassembling the chimney.

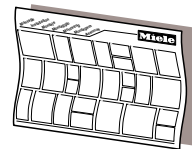

d/mac3mle

**Installation plan**

# Installation

## Appliance dimensions

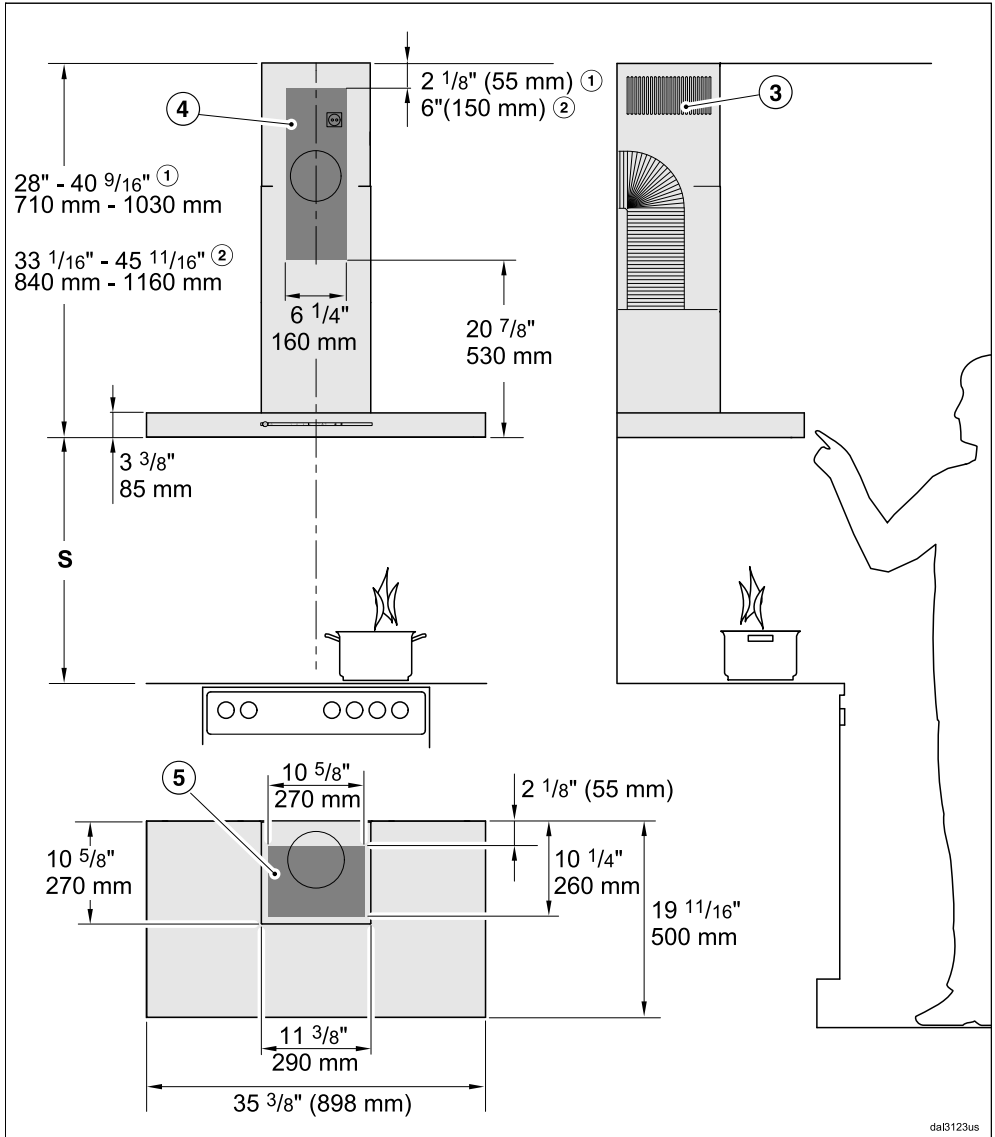

The drawing is not to scale.

- ① Extraction
- ② Recirculation

- ③ Air vent positioned at top for recirculation
- ④⑤ Mounting area (only ④ is required for recirculation hoods). Wall and ceiling area for exhaust duct opening and for wall socket installation. Only the wall socket installation is required for recirculation hoods.

Vent collar Ø 6" (150 mm), with adapter Ø 5" (125 mm).

## Distance between cooktop and ventilation hood (S)

Provided a larger distance is not given by the manufacturer of the cooktop, follow the minimum safety distances between a cooktop and the bottom of the hood.

Please also observe the information contained in the "IMPORTANT SAFETY INSTRUCTIONS" section.

Cooking appliance	Minimum distance S	
	Miele appliance	Non-Miele appliance
Electric Cooktops	24" (610 mm)	
Electric Barbeques and Fryers	26" (660 mm)	
Multiburner Gas Cooktops ≤ 43,000 BTU/hr (12.6 kW), no burner > 15,000 BTU/hr (4.5 kW).	26" (660 mm)	30" (760 mm)
Multiburner Gas Cooktops ≤ 73,800 BTU/hr (21.6 kW), no burner > 16,500 BTU/hr (4.8 kW)	30" (760 mm)	
Multiburner Gas Cooktops > 73,800 BTU/hr (21.6 kW), or one of the burners > 16,500 BTU/hr (4.8 kW)	Not possible	
Single Burner Gas Cooktops ≤ 20,500 BTU/hr (6 kW)	26" (660 mm)	30" (760 mm)
Single Burner Gas Cooktops > 20,500 BTU/hr (6 kW) ≤ 27,600 BTU/hr (8.1 kW)	30" (760 mm)	
Single Burner Gas Cooktops > 27,600 BTU/hr (8.1 kW)	Not possible	

# Installation

## Installation recommendations

- A distance of at least 26" (660 mm) is recommended above electric cooktops to provide more workspace and easier cooking under the hood.
- When selecting an installation height, always take the user height into consideration. Users should have ample space to work comfortably on the cooktop and reach the ventilation hood controls with ease.
- Please note that the greater the distance from the cooktop, the less effective the hood is at drawing in the cooking vapors.
- To achieve optimum vapor extraction, the hood must be centered over the cooktop, not to the side.
- The cooktop should be no wider than the hood. Preferably, it should be narrower for better extraction.
- The mounting area must be easily accessible. The ventilation hood should be easy to reach and disassemble in case a service call is necessary. This should be taken into consideration when planning the position of cabinetry, shelves, ceilings or decorative elements in the vicinity of the ventilation hood.

## Drilling diagram for wall mounting

- Please follow the directions given in the installation instructions supplied for drilling.

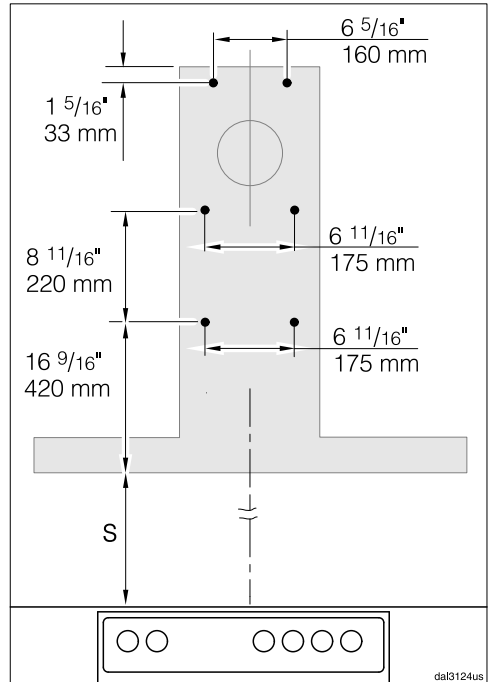

- When installing a custom back wall with pre-drilled holes, please refer to the drilling distances in the drawing above (screws  $\varnothing \frac{3}{16}''$  (5 mm)).

## Plywood backing

The majority of the weight of the installed ventilation system will be supported by the lower retaining plate. It must be firmly attached to the stud framing behind the drywall. If studs are not available in the required locations, a plywood backing (min. ½" (13 mm) thick) spanning at least two studs must be installed.

Failure to adequately support the weight as stated may result in the ventilation system falling off the wall, causing personal injury and property damage.

If plywood backing is not needed, proceed to the included "Installation diagram".

## To install a plywood backing

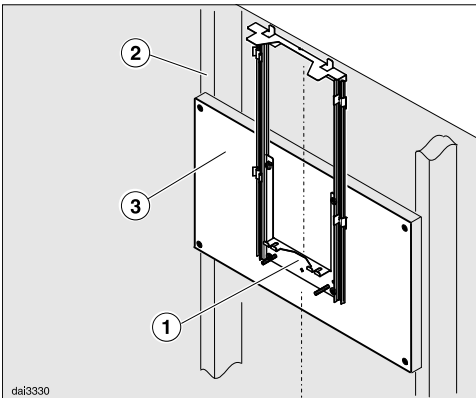

- Determine and mark the location of the retaining plate ① for the canopy as outlined on the "Installation diagram".

- Make a cutting line 3" (76 mm) above and 3" (76 mm) below the outline of the retaining plate.
- Find the studs ② to the left and right of the mounting location by tapping the wall or using a stud finder.
- Mark a vertical cutting line along the center of each stud.

**CAUTION:** When cutting or drilling into the wall or ceiling, do not damage electrical wiring and other hidden utilities.

- Remove the drywall between the cutting lines and replace it with plywood ③ of a matching thickness (min. ½" (13 mm) thick). Tape the joints and refinish the wall.
- Proceed to the enclosed "Installation diagram" to complete the installation.

# Air venting

**WARNING:** Danger of toxic fumes. Gas cooking appliances release carbon monoxide that can be harmful or fatal if inhaled.

To reduce the risk of fire and to properly exhaust air, the exhaust gases extracted by the hood should be vented outside of the building only.

Do not vent exhaust air into spaces within walls or ceilings or in attics, crawl spaces or garages.

To reduce the risk of fire, only use metal ductwork.

Please read and follow the “IMPORTANT SAFETY INSTRUCTIONS” to reduce the risk of personal injury. Follow all local building codes when installing the hood.

Only use smooth pipes or flexible duct hoses made from non-combustible materials for exhaust ductwork.

To achieve the greatest possible air extraction with the lowest noise levels, please note the following:

- The diameter of the exhaust duct should not be less than 6" (150 mm).
- If flat exhaust ducts are used, the cross section should not be smaller than that of the exhaust connector.
- The exhaust duct should be as short and straight as possible.
- If elbows are needed, make sure they have a large radius.
- The exhaust duct itself must not be kinked or compressed.

- Make sure that all connections are secure and airtight.

Remember that any constriction of the airflow will reduce extraction performance and increase operating noise.

- If the exhaust duct is to be routed through an outside wall, we recommend installing a telescopic wall vent or a rooftop vent.

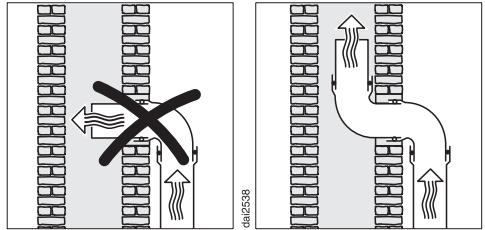

- If the exhaust air is conveyed into an exhaust air chimney, the inlet connector must face the flow direction.
- When installing the exhaust duct horizontally, a minimum slope of  $\frac{1}{8}$  inch per foot must be maintained to prevent condensate from flowing into the ventilation hood.
- If the exhaust duct is to be routed through cool rooms, ceilings, etc., the temperatures in these different areas may differ greatly. Therefore water condensation must be considered and the exhaust duct will need to be insulated.

## Condensate trap

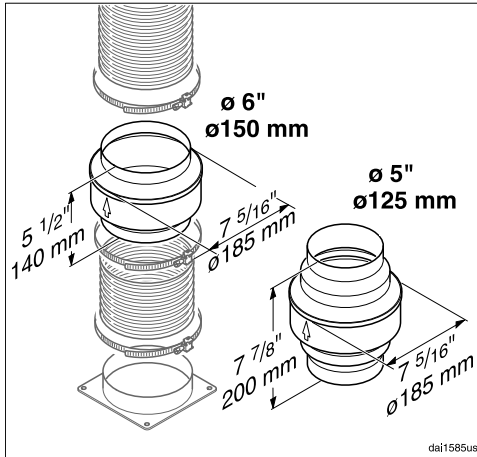

In addition to insulating the exhaust duct, we recommend installing a condensate trap to collect and evaporate any condensate which might accumulate.

Condensate traps are available for exhaust ducts with a diameter of 5" (125 mm) or 6" (150 mm).

- When installing a condensate trap, make sure that it is positioned vertically and, if possible, directly above the hood outlet duct collar. The arrow on the housing indicates the direction of airflow.

## Reducing Collar

(optional accessory)

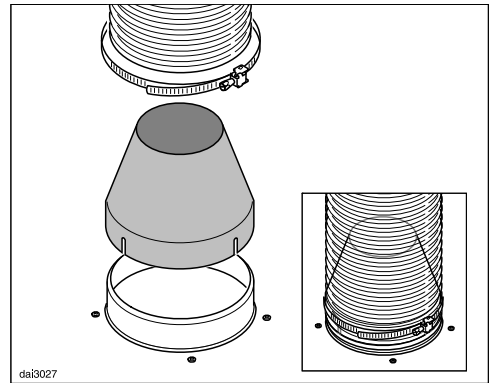

If you would like to reduce the environmental impact of your ventilation system by limiting the CFM output the Reducing Collar can be installed. It reduces the air flow to less than 400 CFM. Check local building codes for max. CFM requirements.

- Push the Reducing Collar on the exhaust port of the blower.
- Push the exhaust hose over it.
- Secure both with a hose clamp.

# Electrical connection

**WARNING: TO REDUCE THE RISK OF FIRE, ELECTRIC SHOCK, OR INJURY TO PERSONS, OBSERVE THE FOLLOWING:**

All electrical work should be performed by a qualified electrician in strict accordance with national regulations (for USA: ANSI-NFPA 70) and local safety regulations.

Installation, repairs and other work by unqualified persons could be dangerous.

Ensure that power to the appliance is OFF while installation or repair work is performed.

Verify that the voltage, load and circuit rating information found on the data plate (located behind the baffle filters), match the household electrical supply before installing the hood.

Use only with ventilation hood cord-connection kits that have been investigated and found acceptable for use with this model hood.

If there is any question concerning the electrical connection of this appliance to your power supply, please consult a licensed electrician or call Miele's Technical Service Department.

**WARNING: THIS APPLIANCE MUST BE GROUNDED**

## Grounding Instructions

**WARNING - Improper grounding can result in a risk of electric shock.**

This appliance must be grounded. In the event of an electrical short circuit, grounding reduces the risk of electric shock by providing a path of least resistance. This appliance is equipped with a cord having a grounding wire with a grounding plug.

If there is any doubt, have the electrical system of the house checked by a qualified electrician.

Do not use an extension cord. If the power supply cord is too short, have a qualified electrician install an outlet near the appliance.

- The plug must be plugged into an outlet that is properly installed and grounded.

**WARNING - Grounding instructions (Canada)**

The grounding-type attachment plug shall be connected to a grounding-type receptacle installed in accordance with CSA C22.1-12, Canadian Electrical Code, Part I.



For faults that you cannot resolve on your own, please contact your Miele dealer or Miele Technical Service.

The telephone number for Miele is listed at the back of these instructions.

When contacting Miele, please state the model and serial number of your ventilation hood.

These can be found on the data plate.

### Location of the data plate

The data plate is visible once you have removed the grease filters.

### Warranty

For further information, please refer to your warranty booklet.

### MieleCare

This service is available in USA only.
--

**MieleCare**, our Extended Service Contract program, gives you the assurance of knowing that your appliance investment is covered by 5 years of worry free ownership.

**MieleCare** is the only Extended Service Contract in the industry that guarantees repairs by a Miele Authorized Service Provider using genuine Miele parts. Only genuine Miele parts installed by factory trained professionals can guarantee the safety, reliability, and longevity of your Miele appliance.

Please note that unless expressly approved in writing by Miele's Service department, Extended Service Contracts offered by other providers for Miele products will not be recognized by Miele. Our goal is to prevent unauthorized (and untrained) service personnel from working on your Miele products, possibly doing further damage to them, you and/or your home.

To learn more about **MieleCare** Extended Service Contracts, please contact your appliance dealer or visit us online at:  
[www.mieleusa.com](http://www.mieleusa.com)

# Technical data

Blower motor	350 W
Overhead lighting	3 x 3 W
Total connected load	359 W
Supply voltage, frequency	120 V AC, 60 Hz
Fuse	15 A
Power cord length	2.5 ft (0.75 m)
Weight	57.2 lbs (26 kg)

## WiFi module

Frequency band	2.412–2.462 GHz
Maximum transmission power	< 100 mW

## ZigBee® module

Frequency band	2.405–2.48 GHz
Maximum transmission power	< 10 mW

## Optional accessories for recirculation mode

DUW 20 conversion kit and DKF 12-900 charcoal filter



### WiFi module EK037

FCC ID: 2ACUWEK037

IC: 5669C-EK037

### ZigBee® module EK038

FCC ID: 2ACUWEK038

IC: 5669C-EK038

This device complies with Part 15 of the FCC Rules and with Industry Canada licence-exempt RSS standard(s). Operation is subject to the following two conditions: (1) this device may not cause harmful interference, and (2) this device must accept any interference received, including interference that may cause undesired operation.

da3491

Please have the model and serial number of your appliance available when contacting Technical Service.

---

The Miele logo consists of the word "Miele" in a bold, white, serif font, set against a solid black rectangular background.

## **U.S.A.**

**Miele, Inc.**

### **National Headquarters**

9 Independence Way  
Princeton, NJ 08540  
Phone: 800-843-7231  
Fax: 609-419-4298  
[www.mieleusa.com](http://www.mieleusa.com)

### **Technical Service & Support**

Phone: 800-999-1360  
Fax: 888-586-8056  
[TechnicalService@mieleusa.com](mailto:TechnicalService@mieleusa.com)

### **International Headquarters**

Miele & Cie. KG  
Carl-Miele-Straße 29  
33332 Gütersloh  
Germany

## **Canada**

**Importer**  
**Miele Limited**

### **Headquarters and Miele Centre**

161 Four Valley Drive  
Vaughan, ON L4K 4V8  
[www.miele.ca](http://www.miele.ca)

### **Customer Care Centre**

Phone: 800-565-6435  
905-532-2272  
[customercare@miele.ca](mailto:customercare@miele.ca)

DA 6698 W

en-US

M.-Nr. 10 931 420 / 04