

Operating and Installation Instructions

Ventilation Hood

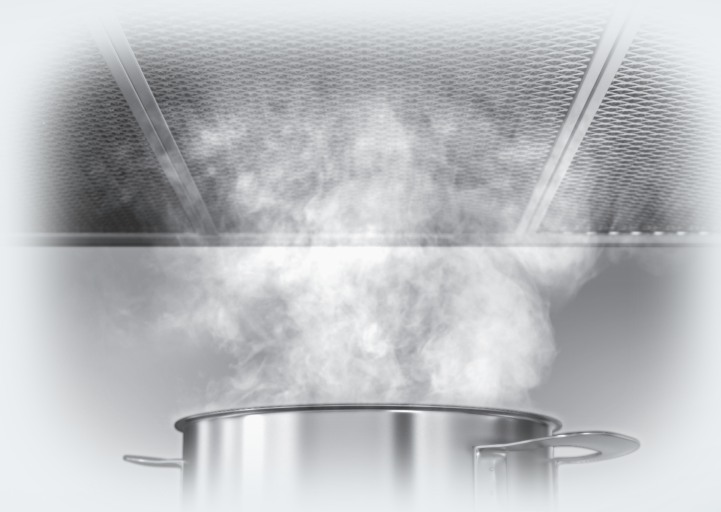

To prevent accidents and damage to the appliance, you **must** read these instructions before installing the appliance and using it for the first time.

Contents

IMPORTANT SAFETY INSTRUCTIONS	4
Description of functions	14
Con@ctivity 2.0 function.....	15
Guide to the appliance	16
Operation (Automatic mode)	18
Cooking with Con@ctivity 2.0 (Automatic mode)	18
Temporarily exiting Automatic mode.....	20
Resuming Automatic mode.....	20
Operation (Manual mode)	21
Cooking without Con@ctivity 2.0 (Manual mode)	21
Turning on the fan.....	21
Selecting the power level	21
Selecting the Delayed shut down time.....	21
Turning off the fan	21
Turning the overhead lighting on/off.....	21
Power management	22
Operation (Automatic and Manual modes)	23
Filter saturation indicator.....	23
Adjusting the filter saturation indicator for grease filters	23
Activating/changing the charcoal filter saturation counter	24
Checking the elapsed operating time	24
Energy-saving tips	25
Cleaning and care	26
Stainless steel housing.....	26
Special instructions for glass surfaces.....	26
Grease filters and edge extraction panel.....	27
OdorFree Charcoal Filter	31
Resetting the filter saturation indicator for the charcoal filter	32
Installation	33
Before installation.....	33
Installation Instructions	33
Installation parts	34
Appliance dimensions	36
Distance between cooktop and ventilation hood (S).....	38
Installation recommendations	39

Exhaust duct	40
Reducing Collar	41
Electrical connection	42
Activating Con@ctivity 2.0	43
Installation of the Con@ctivity 2.0 stick.....	43
Activating the Con@ctivity 2.0 function.....	43
Activating the ventilation hood	43
Activating the cooktop	44
Activation failed.....	44
Deactivating Con@ctivity 2.0.....	44
Service and warranty	45
Location of the data plate	45
MieleCare	45
Technical data	46
Caring for the environment	47

IMPORTANT SAFETY INSTRUCTIONS

READ AND SAVE THESE INSTRUCTIONS

This appliance complies with current safety requirements. Improper use of the appliance can lead to personal injury and material damage.

Read all instructions before installing or using the appliance for the first time. Only use the appliance for its intended purpose.

Keep these operating instructions in a safe place and pass them on to any future user.

Use

- ▶ **CAUTION:** For General Ventilating Use Only. Do Not Use To Exhaust Hazardous Or Explosive Materials And Vapors.
- ▶ This appliance is intended for residential use only. Use only as described in these operating instructions.
- ▶ This ventilation hood is not intended for outdoor use.
- ▶ It must only be used to extract and clean vapors produced during cooking. Any other use occurs at the owner's own risk.
- ▶ This appliance is suitable for installation above gas or electric cooking surfaces.
- ▶ Persons who lack physical, sensory or mental abilities, or experience with the appliance should not use it without supervision or instruction by a responsible person.

IMPORTANT SAFETY INSTRUCTIONS

Children

- ▶ As with any appliance, close supervision is necessary when used by children.
- ▶ Please supervise children in the vicinity of the hood and do not let them play with it.
- ▶ Danger of suffocation! Ensure that any plastic wrappings, bags, etc. are disposed of safely and kept out of the reach of children.

Technical safety

- ▶ **WARNING: TO REDUCE THE RISK OF FIRE, ELECTRIC SHOCK, OR INJURY TO PERSONS, OBSERVE THE FOLLOWING:**
 - Use this appliance only in the manner intended by the manufacturer. If you have questions, contact Miele.
 - Before servicing or cleaning the appliance, switch power off at the service panel and lock the service disconnecting means to prevent power from being switched on accidentally. If the service disconnecting means cannot be locked, securely fasten a prominent warning device, such as a tag, to the service panel.
- ▶ Installation, repair and maintenance work should be performed by a Miele authorized service technician in accordance with national and local safety regulations and the provided installation instructions. Contact Miele's Technical Service Department for examination, repair or adjustment. Repairs and other work by unauthorized persons could be dangerous and may void the warranty.
- ▶ A damaged ventilation hood oven can be dangerous. Always check for visible signs of damage. Never use a damaged ventilation hood.

IMPORTANT SAFETY INSTRUCTIONS

- ▶ Be certain your appliance is properly installed and grounded by a qualified technician. To guarantee the electrical safety of this appliance, continuity must exist between the appliance and an effective grounding system. It is imperative that this basic safety requirement be met. If there is any doubt, have the electrical system of the house checked by a qualified electrician.
- ▶ Reliable and safe operation of this hood can only be guaranteed if it has been connected to the electrical supply.
- ▶ To avoid damaging the ventilation hood, make sure that the connection data (voltage and frequency) on the data plate correspond to the building's power supply before connecting the appliance. When in doubt, consult a qualified electrician.
- ▶ Do not use a power bar or extension cord to connect the ventilation hood to electricity. These are a fire hazard and do not guarantee the required level of appliance safety.
- ▶ To ensure safe operation, only use the ventilation hood after it has been properly installed.
- ▶ This ventilation hood may not be used in non-stationary locations (e.g. on a ship).
- ▶ Adequate ventilation must be provided when the hood is operated simultaneously with devices that burn gas or other fuels.
- ▶ Only open the housing as described in the enclosed "Installation diagram" and in the "Cleaning and care" section of this manual. Under no circumstances should any other parts of the housing be opened.
Tampering with electrical connections or components and mechanical parts is highly dangerous to the user and can cause operation faults.
- ▶ Defective components should be replaced by Miele original parts only. Only with these parts can the manufacturer guarantee the safety of the appliance.

IMPORTANT SAFETY INSTRUCTIONS

- ▶ If the power cord is damaged, it must only be replaced by a qualified service technician.
- ▶ During installation, maintenance, and repair work, the ventilation hood must be disconnected from the electrical supply. It is only completely isolated from the electricity supply if one of the following applies:
 - The circuit breakers on the electrical service panel are tripped.
 - The screw-type fuses on the electrical service panel have been removed.
 - The power cable (if present) has been unplugged from the socket (pull the plug not the cord).

Proper use

- ▶ **WARNING: TO REDUCE THE RISK OF A COOKTOP GREASE FIRE:**
 - a) Never leave surface units unattended at high settings. Boilovers cause smoking and greasy spillovers may ignite. Heat oils slowly on low or medium settings.
 - b) Always turn the hood on when cooking at a high heat.
 - c) Clean the ventilation hood frequently. Grease should not be allowed to accumulate on the fan or filter.
 - d) Use the proper pan size. Always use cookware appropriate for the size of the cooking area.
- ▶ Never use an open flame beneath the ventilation hood. To avoid the risk of fire, do not flambé or grill over an open flame. When turned on, the ventilation hood will draw any flames into the filter. Fat deposits may ignite.

IMPORTANT SAFETY INSTRUCTIONS

▶ **WARNING: TO REDUCE THE RISK OF INJURY TO PERSONS IN THE EVENT OF A COOKTOP GREASE FIRE, OBSERVE THE FOLLOWING*:**

- a) **SMOTHER FLAMES** with a close fitting lid, cookie sheet, or metal tray then turn off the burner. **BE CAREFUL TO PREVENT BURNS.** If the flames do not go out immediately, **EVACUATE AND CALL THE FIRE DEPARTMENT.**
- b) **NEVER PICK UP A FLAMING PAN** - You may be burned.
- c) **DO NOT USE WATER**, including wet dishcloths or towels - a violent steam explosion will result.
- d) Use a fire extinguisher **ONLY** if:
 - 1) You have a class ABC extinguisher, and you know how to operate it.
 - 2) The fire is small and contained in the area where it started.
 - 3) The fire department is being called.
 - 4) You can fight the fire with your back to an exit.

*Based on "Kitchen Firesafety Tips" published by NFPA.

▶ The ventilation hood may become damaged if exposed to excessive heat from a gas cooktop.

- When using the ventilation hood over a gas cooktop, ensure that any burners in use are always covered by cookware. Turn burners off when removing the cookware, even if doing so for just a short time.
 - Select cookware that is suitable for the size of the burner.
 - Adjust the flame so that it never extends up the sides of the cookware.
 - Avoid overheating the cookware (e.g., when cooking with a wok).
- ▶ Always turn the ventilation hood on whenever a burner is in use to prevent damage from condensation.

IMPORTANT SAFETY INSTRUCTIONS

▶ Overheated oils and fats can ignite and set the ventilation hood on fire.

When cooking with oils or fats, do not leave pots, pans or fryers unattended. Never leave an electric grill unattended when grilling.

▶ Fat and debris deposits impair the proper functioning of the ventilation hood.

To ensure that cooking vapors are properly cleaned, never use the ventilation hood without the grease filters in place.

▶ Please note that the heat rising from the stovetop during cooking can cause the ventilation hood to become very hot.

Do not touch the housing or the grease filters until the ventilation hood has cooled down.

IMPORTANT SAFETY INSTRUCTIONS

Proper installation

- ▶ **WARNING: TO REDUCE THE RISK OF FIRE, ELECTRIC SHOCK, OR INJURY TO PERSONS, OBSERVE THE FOLLOWING:**
 - a) Installation work and electrical wiring must be done by qualified person(s) in accordance with all applicable codes and standards, including fire-rated construction.
 - b) Sufficient air is needed for combustion and exhausting of gases through the flue (chimney of fuel burning equipment to prevent back drafting. Follow the heating equipment manufacturer's guideline and safety standards such as those published by the National Fire Protection Association (NFPA) and the American Society for Heating, Refrigeration and Air Conditioning Engineers (ASHRAE), and the local code authorities.
 - c) When cutting or drilling into the wall or ceiling, do not damage electrical wiring and other hidden utilities.
 - d) Ducted hoods must always be vented to the outdoors.
 - e) Do not use this hood with any solid-state speed control device.
- ▶ To determine whether a ventilation hood may be operated above your cooking appliance, please refer to the information provided by the appliance's manufacturer.
- ▶ Safety regulations prohibit the installation of a ventilation hood above solid fuel stoves.
- ▶ Insufficient distance between the cooking appliance and the ventilation hood can result in damage to the hood.
The minimum safety distances between the appliance and the bottom of the ventilation hood specified in the "Installation" section must be maintained, unless the appliance's manufacturer has indicated that a greater distance is required.
If more than one cooking appliance is used beneath the ventilation hood, and if different minimum safety distances apply for these appliances, you should use the greater distance.

IMPORTANT SAFETY INSTRUCTIONS

- ▶ Be sure to observe the information contained in the "Installation" section when mounting the ventilation hood.
- ▶ Metal parts can have sharp edges which may cause injury. Wear gloves to protect your hands from being cut.
- ▶ When installing the exhaust duct, only use pipes or tubes made of non-flammable material. These can be obtained from your Miele dealer or from Miele Technical Service.
- ▶ Exhaust air should not be vented into a chimney or vent flue which is otherwise in use and should not be channeled into ducting which ventilates rooms with fuel-burning installations.
- ▶ If exhaust air is to be extracted into a chimney or vent flue no longer used for other purposes, be sure to comply with all applicable regulations.
- ▶ **WARNING: TO REDUCE THE RISK OF FIRE USE ONLY METAL DUCTWORK.**

IMPORTANT SAFETY INSTRUCTIONS

Cleaning and care

- ▶ There is a risk of fire if cleaning is not completed according to the instructions in this manual.
- ▶ Never use a steam cleaner to clean the ventilation hood. The steam can reach the electrical components and cause a short circuit.

Accessories

- ▶ Use only genuine original Miele parts. If parts or accessories from other manufacturers are used, the warranty will become void.

IMPORTANT SAFETY INSTRUCTIONS

FCC Declaration of Conformity

▶ These devices comply with FCC Rules Part 15. This equipment has been tested and found to be in compliance with the limits for a Class B digital device, pursuant to Part 15 of the FCC Rules of Operation and is subject to the following conditions:
These devices may not cause harmful interference.
These devices must accept any interference received, including interference that may cause undesired operation.

FCC Radiation Exposure Statement

▶ This equipment complies with FCC radiation exposure limits set forth for an uncontrolled environment. This equipment should be installed and operated with minimum distance 8" (20 cm) between the radiator and your body.

Industry Canada Statement

▶ This digital apparatus does not exceed the Class B limits for Radio Noise Emissions from digital apparatus set out in the Radio Interference Regulations of the Canadian Department of Communications.

Complies with Canadian ICES-003 Class B specifications.

Description of functions

The following functions are available on your ventilation hood, depending on the model:

Vented mode

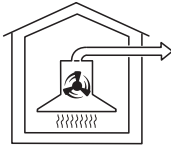

daii0494a

The cooking vapors are drawn in by the ventilation hood. The air is then passed via the edge extraction panel through the grease filters, cleaned and then directed outside.

Recirculation mode



daii0494b

The air is drawn in and passed via the edge extraction panel through the grease filters and then through two charcoal filters. The cleaned air is then recirculated back into the kitchen.

Con@ctivity 2.0 function

Automatic control

This hood features a communication function which enables the automatic control of the hood based on the operational status of a Miele induction cooktop.

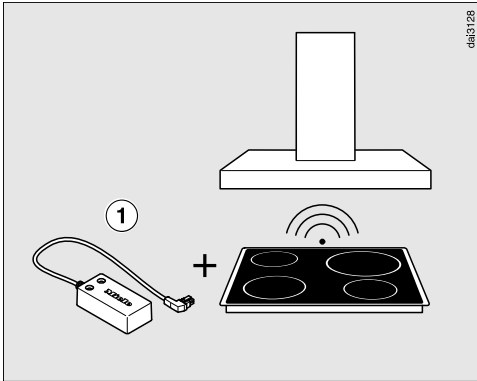

To enable the communication function, the cooktop must be equipped with the corresponding Con@ctivity 2.0 stick ①.

Please refer to the installation instructions for the Con@ctivity 2.0 stick to determine whether connection to your cooktop is possible.

There must be radio contact between the cooktop and the hood for you to be able to use the Con@ctivity 2.0 function (see "Activating Con@ctivity 2.0").

The cooktop transmits information about its operational status to the hood using a radio signal.

- When a burner is turned on, the cooktop lighting on the hood turns on automatically. After a brief delay, the ventilation hood fan also comes on.
- During cooking, the hood automatically selects the fan level based on the number of burners in operation and their power levels.
- Once you have turned off the cooktop, the fan and the lighting will turn off automatically after a predetermined delay.

Detailed information about this function can be found under "Operation."

Guide to the appliance

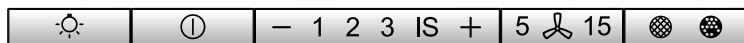
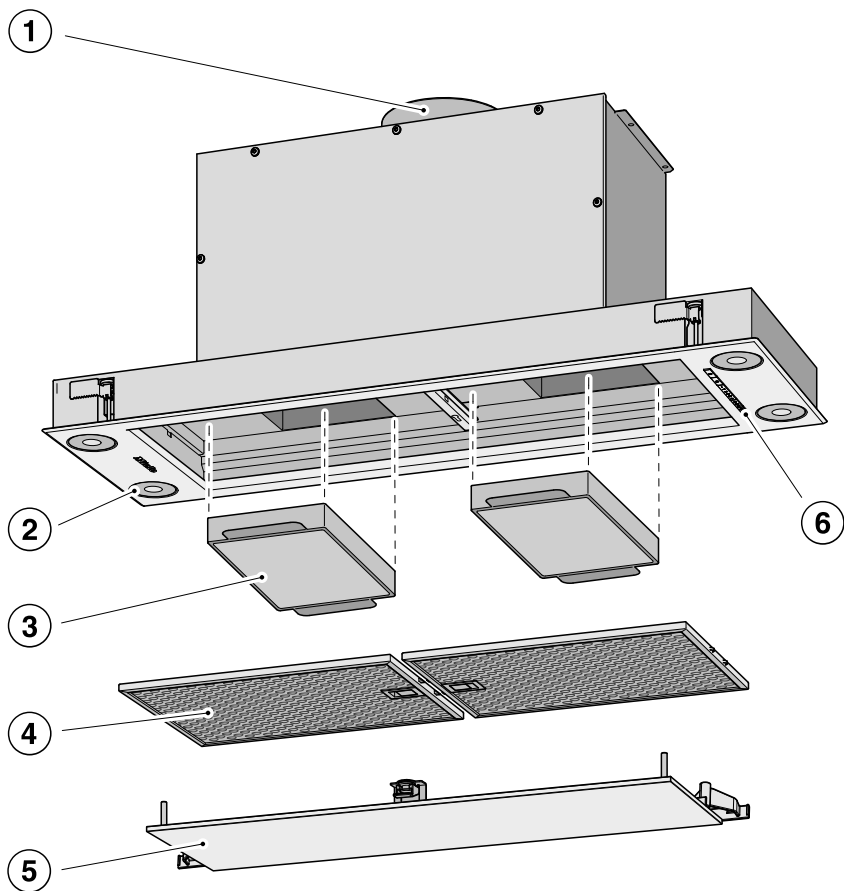

7

8

9

10

11

- ① Vent connection
Extraction ducting can be directed through the back of the ventilation hood, upwards to the ceiling, or to the side.
- ② Overhead cooktop lighting
- ③ Active charcoal filters (x 2)
Optional accessory for recirculation mode
- ④ Grease filters
- ⑤ Edge extraction panel
- ⑥ Control panel
- ⑦ Overhead lighting button
- ⑧ On / Off button for fan
- ⑨ Buttons for setting the fan power
- ⑩ Delayed shut down button
- ⑪ Filter saturation indicator

Operation (Automatic mode)

When Con@ctivity 2.0 is active, the hood always operates in Automatic mode (see "Activating Con@ctivity 2.0").

See "Cooking without Con@ctivity 2.0" for information on manually operating the hood.

Cooking with Con@ctivity 2.0 (Automatic mode)

- Turn on a burner to the desired power setting.

Overhead cooktop lighting.

After a few seconds, the fan will come on, briefly operating at power level **2** before immediately switching to level **1**.

The hood selects the fan level automatically during cooking.

This level is determined by the total output of the cooktop, i.e. the number of burners in operation and the power settings selected.

- If you select a higher power setting on the cooktop or switch on multiple burners, the hood will switch to a higher fan level.
- If you select a lower power setting on the cooktop or turn off a burner, the hood will accordingly switch to a lower fan level.

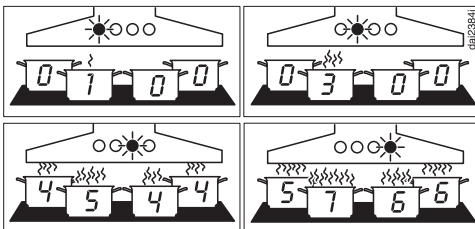

Examples for fan levels **1** to **4**

Reaction time

Changing the power setting on the cooktop does not lead to an immediate increase or decrease in cooking vapors. For this reason, the hood reacts with a slight delay.

Delays can also result from the fact that the cooktop transmits the information to the hood in intervals.

The reaction time can vary from a few seconds to a couple of minutes.

Cooking process

- If, for example, you switch on a burner at the highest power setting to heat cookware in preparation for searing and then reduce the power level after approx. 60 to 90 seconds, a cooking process is recognized.

The hood turns on automatically and, after the cooktop power level has been reduced, switches back to fan level 3, where it remains for approx. 5 minutes.

After this, the fan level is once again determined by the Con@ctivity function.

- You can also manually select a different fan level before then.

Deactivation

- Turn off all burners.

Over the next few minutes, the ventilation hood fan setting will decrease one level at a time until the hood eventually turns off.

This helps to neutralize any lingering vapors and odors in the air.

- From the intensive setting, the fan immediately switches to level 3.
- If the fan is operating at level 3, it will switch to level 2 after approx. 1 minute.
- From level 2, the fan switches to level 1 after 2 minutes.
- After 2 minutes at level 1, the fan automatically turns off.
- After another 30 seconds, the overhead cooktop lighting turns off.

The cooking process is now finished.

Operation (Automatic mode)

Temporarily exiting Automatic mode

To temporarily exit the Automatic mode when cooking:

- Manually select a different fan level, or
- Manually turn the hood off, or
- Activate the Delayed shut down function  on the ventilation hood. The fan turns off after the delay time selected, and the lighting will remain on.

The ventilation hood functions can now be operated manually (see "Cooking without Con@ctivity 2.0").

Resuming Automatic mode

The ventilation hood resumes Automatic mode:

- If the ventilation hood has not been used for a period of approx. 5 minutes after the manual selection of a fan level, or
- If the manually selected fan level once again matches the automatic setting, or
- If the ventilation hood fan and the cooktop have been turned off for at least 30 seconds. Automatic mode will resume the next time the cooktop is turned on.
- If you wish to manually operate the ventilation hood for a complete cooking process, turn on the ventilation hood fan **before** turning on the cooktop. If the ventilation hood and the cooktop have been turned off for at least 30 seconds after you have finished cooking, Automatic mode will resume the next time the cooktop is turned on.

Cooking without Con@ctivity 2.0 (Manual mode)

The hood can be operated manually if:

- The Con@ctivity 2.0 function is not activated.
- You have temporarily deactivated the Con@ctivity 2.0 function (see "Temporarily exiting Automatic mode").

Turning on the fan

- Press the On/Off button .

The fan turns on at level **2**. The  symbol and **2** will light up in the fan level display.

Selecting the power level

Power levels **1** to **3** can be used for light to heavy cooking vapors and odors.

For strong vapors and odors that are temporarily produced when cooking, e.g. during searing, select the **IS** level as an intensive setting.

- Press the "-" button for a lower power level or the "+" button to select a higher level.



Reducing power of the intensive setting

If power management is activated (default setting), the fan automatically switches back to level **3** after 5 minutes.

Selecting the Delayed shut down time

It is a good idea to let the fan run for a few more minutes after cooking in order to neutralize any lingering vapors and odors in the air.

With the Delayed shut down function, it is possible to have the fan automatically shut off after a predetermined period of time.

- After you have finished cooking, press the Delayed shut down button **5**  **15**
- Once: fan turns off after 5 minutes (**5** lights up).
- Twice: fan turns off after 15 minutes (**15** lights up).
- If you press the Delayed shut down button **5**  **15** again, the fan remains turned on (**5**  **15** goes out).

Turning off the fan

- Press the On/Off button  to turn the fan off.

The  symbol will go out.

Turning the overhead lighting on/off

The overhead lighting can be turned on and off separately from the fan.

- To do so, press the  button.

The  symbol is lit when the overhead lighting is turned on.

Operation (Manual mode)

Power management



The ventilation hood features a power management system to help save energy. The fan power level is reduced and the lighting is turned off automatically.

- If the intensive setting is selected, the fan automatically switches to level 3 after 5 minutes.
- If the fan is set to level 3, 2 or 1, it switches back one fan setting after 2 hours and then in 30-minute intervals until the fan eventually switches off.
- If the overhead lighting is on, it automatically turns off after 12 hours.

Turning power management On/Off

You can deactivate the power management.

This can result in increased electricity consumption.

- Turn off the fan and the lighting.
- Press and hold the Delayed shut down button **5**  **15** for approx. 10 seconds until **1** appears in the fan level display.
- Then, press the following buttons in order:
 - The lighting button ,
 - Followed by the "—" button and then
 - The lighting button  again.

If power management is turned on, the **1** and **IS** indicators will be continuously lit.

If it is turned off, **1** and **IS** will flash.

- Press the "—" button to turn power management off.

The **1** and **IS** indicators will flash.

- To turn it on, press the "+" button.

The **1** and **IS** indicators are constantly lit.

- Confirm the setting by pressing the Delayed shut down button **5**  **15**.



All the indicator lights go out.

If the new setting is not confirmed within 4 minutes, the hood reverts to the previous setting.

Operation (Automatic and Manual modes)

Filter saturation indicator





The number of hours the hood has been in operation is stored in appliance memory.

The filter saturation indicators show when the filters need to be cleaned or changed by lighting up the grease filter symbol  or OdorFree Charcoal Filter symbol . Additional information on cleaning and changing the filters and resetting the filter saturation counters can be found under "Cleaning and care."

Adjusting the filter saturation indicator for grease filters

You can set the filter saturation indicator to suit your cooking habits.



The factory default setting is an interval of 30 hours.

- Select a shorter time (20 hours) if you often fry foods.
- We also recommend a shorter cleaning interval if you only cook occasionally. This will prevent grease buildup from hardening and making cleaning more difficult.
- Select a longer cleaning interval of 40 or 50 hours if you use very little fat when cooking.
- Press the On/Off button  to turn the fan off.
- Press the Delayed shut down button  **5**  **15** and the filter saturation button   at the same time.

The grease filter symbol  on the filter saturation button and one of the fan power level indicators will flash.

Fan power level indicators **1** to **IS** show the current time setting:

Indicator 1	20 hours
Indicator 2	30 hours
Indicator 3	40 hours
Indicator IS	50 hours

- Press the "-" symbol for a shorter operating time, or the "+" symbol to select a longer operating time.
- Confirm the selection by pressing the filter saturation indicator  .

All the indicator lights will go out.



If the setting is not confirmed within 4 minutes, the ventilation hood automatically reverts to the old setting.

Operation (Automatic and Manual modes)

Activating/changing the charcoal filter saturation counter

Charcoal filters are necessary for recirculation mode.



The filter saturation counter for the charcoal filter requires one-time activation and must be set to match your cooking habits.

- Press the On/Off button  to turn the fan off.
- Press the + symbol and the filter saturation indicator   at the same time.

The charcoal filter symbol  and one of the fan power level indicators will flash.

The indicators **1** to **IS** show the current time setting:

Indicator 1	120 hours
Indicator 2	180 hours
Indicator 3	240 hours
Indicator IS	deactivated





- Press the "-" symbol for a shorter operating time, or the "+" symbol to select a longer operating time.
- Confirm the selection by pressing the filter saturation indicator  .

All the indicator lights go out.

If the new setting is not confirmed within 4 minutes, the hood reverts to the previous setting.

Checking the elapsed operating time

Before the set operating time interval has been reached, you can check what percentage of the time has elapsed.

- Press the On/Off button  to switch the fan on.
- Press and hold the filter saturation indicator  :
 - Once, to check the grease filter operating time. The grease filter symbol  lights up.
 - Twice, to check the charcoal filter saturation. The OdorFree Charcoal Filter symbol  lights up.

One or more of the fan power level indicators will flash simultaneously.

The number of flashing indicators shows the elapsed operating time as a percentage.

Indicator 1	25%
Indicators 1 and 2	50%
Indicators 1 to 3	75%
Indicators 1 to IS	100%

The elapsed operating time remains stored in the memory when the ventilation hood is turned off or if power to the appliance is lost.

This hood operates in a very efficient and energy-saving manner. The following will help you to save even more energy when using it:

- Ensure that there is sufficient ventilation in the kitchen when cooking. If there is insufficient air flow during extraction mode, the hood cannot operate efficiently, causing increased operating noise levels.
- Use the Con@ctivity function. The ventilation hood will switch on and off automatically at the optimum power level for the cooking you are doing, which ensures low energy consumption.
- If you are operating the ventilation hood manually, please note the following:
 - Check the power level selected on the hood. A lower power level is generally sufficient for the majority of cooking. Only use the intensive setting when necessary.
 - When a large volume of cooking vapors are being produced, switch to a high power level in good time. This is more efficient than operating the hood for longer to try to capture cooking vapors that have already been distributed throughout the kitchen.
 - Make sure that you switch the ventilation hood off after use. If cooking vapors and odors still need to be removed from the kitchen air after cooking, use the coast-down function. The fan will switch off automatically after the selected coast-down time.

- Clean or change the filters at regular intervals. Heavily soiled filters reduce performance, increase the risk of fire and are unhygienic.

Cleaning and care

WARNING: TO REDUCE THE RISK OF FIRE, ELECTRIC SHOCK, OR INJURY TO PERSONS, OBSERVE THE FOLLOWING:

- Before cleaning or servicing the hood, disconnect it from the power supply, see "IMPORTANT SAFETY INSTRUCTIONS".

Stainless steel housing

General information

The surfaces and control buttons are susceptible to scratching and chipping. Observe the following cleaning instructions.

- Clean all surfaces and control buttons using warm water and liquid dish soap. Apply with a sponge cloth.

Make sure that no water gets into the interior of the hood. Only use a damp cloth to clean the hood, especially in the control panel area.

- After cleaning, dry the surfaces with a soft cloth.

Avoid the following:

- Cleaners containing soda, acid or chloride, or cleaners containing solvents
- Abrasive sponges, e.g. pot scourers or sponges which have been previously used with abrasive cleaning agents.

Special instructions for stainless steel surfaces

(does not apply to control buttons)

- Stainless steel surfaces can also be cleaned using a non-abrasive stainless steel cleaner, available from Miele.
- To prevent the surfaces from quickly becoming dirty again, we recommend treating them with a stainless steel care conditioner. Apply sparingly over the entire area using a soft cloth.

Special instructions for RAL color finish housing

- Observe the general cleaning instructions contained in this chapter.

It is very difficult to clean this type of surface without causing minor marks to the surface material. This can become particularly noticeable if there is halogen lighting in the kitchen.

Special instructions for glass surfaces

- Glass surfaces can be cleaned using a cleaning agent specifically designed for glass.

Important for the controls

Do not leave dirt and debris on the buttons for any length of time. Otherwise they may become discolored or damaged. Remove any dirt or debris immediately.

- Observe the general cleaning instructions contained in this chapter.

Do not use a stainless steel cleaner to clean the control buttons.

Grease filters and edge extraction panel

The edge extraction panel and the reusable metal grease filters in the appliance remove solid particles (grease, dust, etc.) from the kitchen vapors, preventing soiling of the hood.

 A dirty filter is a fire hazard!

Cleaning intervals

Grease which has collected in the ventilation hood hardens over time and makes cleaning more difficult. It is therefore recommended that the edge extraction panel and the grease filters should be cleaned regularly (at least every 3–4 weeks) to avoid a build-up of grease.

Clean the edge extraction panels and grease filter immediately if the grease filter symbol  on the filter saturation indicator lights up.

- You can adjust the interval of the filter saturation counter to match your cooking habits (see "Operation").

Cleaning and care

Removing the panel and grease filters

The panel and grease filter can fall out when you are handling them. This can result in damage. Make sure you hold the panel and the grease filters securely at all times when handling them.

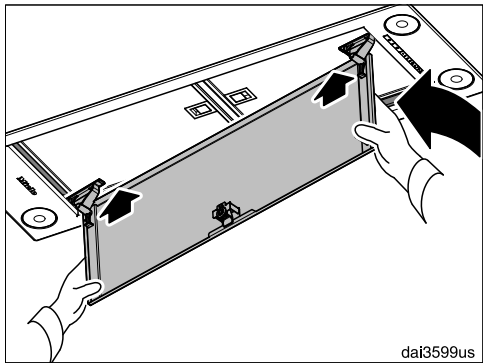
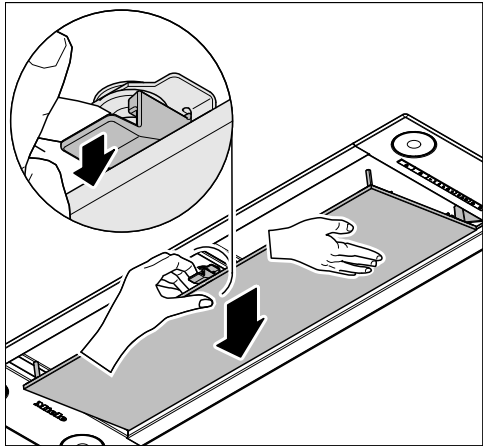

- Hold the panel with one hand and release the lock with the other hand. Swivel the panel down.
- Lift the panel upwards somewhat, and then swivel it forwards.

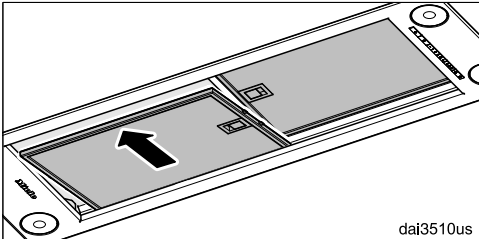
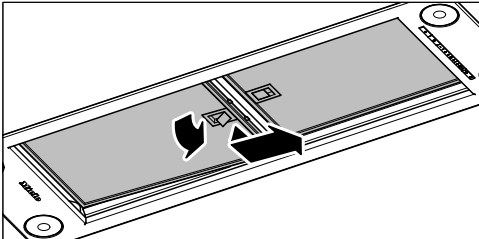

dai3510us

- Open the grease filter locking clamp and remove the grease filter.

Cleaning the panel by hand

- Follow the instructions under "Housing."

Cleaning the grease filters by hand

- Clean the filters with a soft nylon brush in a mild solution of hot water and dish soap. Do not use undiluted dish soap.

Unsuitable cleaning agents

Unsuitable cleaners can cause damage to the filter surfaces if used regularly.

Do not use any of the following:

- Lime removers
- Abrasive powders or abrasive liquids
- Aggressive all-purpose cleaners and degreaser sprays
- Oven sprays

Cleaning the panel and the grease filters in the dishwasher

- Place the panel and grease filters upright or slightly inclined in the lower basket, with the short sides upright, ensuring the spray arm is not obstructed.
- Use a household dishwasher detergent.
- Select a program with a wash temperature between 120°F (50°C) and 150°F (65°C). In a Miele dishwasher use the "Normal" program.

Depending on the detergent used, cleaning the filters in a dishwasher may cause the inside filter surfaces to become discolored. However, this will not affect the functioning of the filters in any way.

Cleaning and care

After cleaning

- After cleaning, leave the filters on an absorbent surface to dry.
- When removing the panel and filters for cleaning, also clean off any accessible oil or grease buildup from the housing. Doing so will prevent a fire hazard.
- Reinstall the grease filters. When inserting the filters, make sure that the locking clip is facing down.

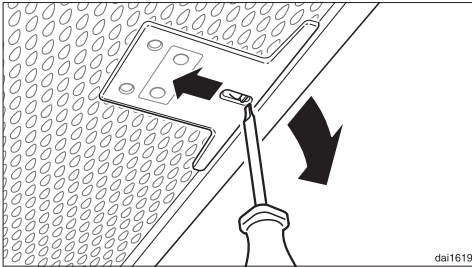

- If the filters have been installed incorrectly, you can insert a small screwdriver into the slit to disengage the locking clip.

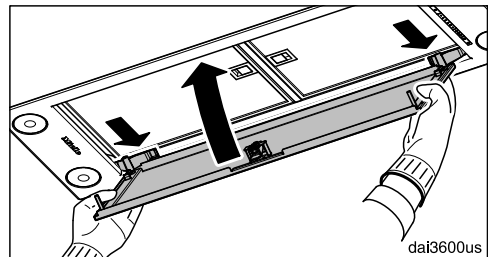
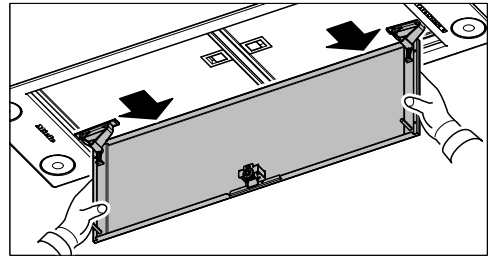
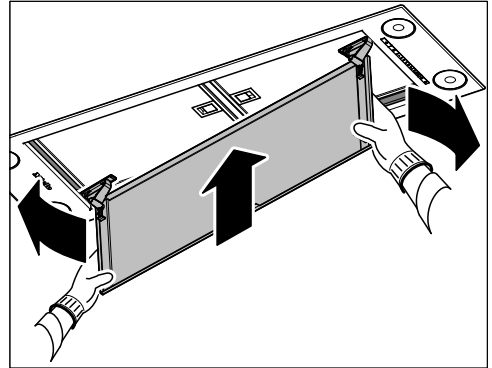

- Swivel the panel into the deflector plate and latch it at the back.
- Swivel it up and forward and press it into the catch.

Resetting the filter saturation counter for the grease filters

Once cleaning is complete, the filter saturation counter must be reset.

- While the fan is turned on, press the filter saturation indicator  for approx. 3 seconds until **1** is the only indicator flashing.

The grease filter symbol  goes out.

When cleaning the grease filters before the full operating time has elapsed:

- Press the filter saturation indicator  for approx. 6 seconds until **1** is the only indicator flashing.

OdorFree Charcoal Filter

With recirculation mode, two charcoal filters must be inserted in addition to the grease filters. These are designed to absorb cooking odors.

They are inserted into the canopy above the grease filters.

Charcoal filters are available from your dealer or from Miele Service.

You will need to order a **DKF 19-1 charcoal filter set**. This set contains two charcoal filters.

Cleaning and care

Installing/replacing the charcoal filter

- Before installing or replacing the charcoal filters, the panel and the grease filters must first be taken out (see previous section for instructions on how to do this).
- Remove the charcoal filter from its packaging.

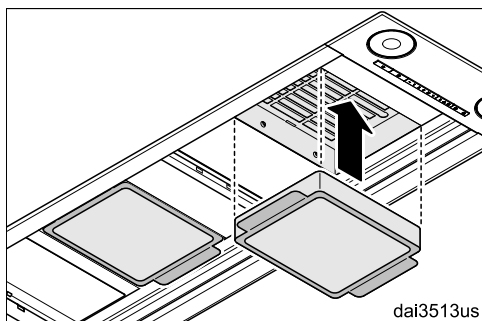

- Press the filters into the frame.
- Reinstall the grease filters.
- When installing the filter for the first time, activate the filter saturation counter (see "Operation").

When to change the OdorFree Charcoal Filter



- Always replace the OdorFree Charcoal Filters whenever they no longer absorb kitchen odors effectively.
The charcoal filters should be replaced at least once every 6 months.

The charcoal filter saturation indicator  will light up to remind you to change the charcoal filter regularly.



- The charcoal filter saturation counter requires one-time activation before use (see the "Operation" chapter).

Resetting the filter saturation indicator for the charcoal filter

If the filter saturation counter is activated, it must be reset each time the filter is changed.

- To do this, press the filter saturation indicator   twice with the fan turned on and hold it for approx. 3 seconds until **1** is the only indicator flashing. The charcoal filter symbol  will go out.

If you replace the charcoal filters **before** the full time interval elapses:

- Press the filter saturation indicator   twice and hold it for approx. 6 seconds until **1** is the only indicator flashing.

Disposing of the OdorFree Charcoal Filter

- Used charcoal filters can be disposed of with normal household waste.

Before installation

 Before installing the appliance, read all of the information contained in this chapter and also in the "IMPORTANT SAFETY INSTRUCTIONS" section.

Installation Instructions

Please refer to the accompanying installation sheet for instructions on how to install the appliance.

Leave these instructions with the appliance for the consumer/user.

Information is subject to change. Please refer to our website to obtain the most current product specification, technical & warranty information.

The ventilation hood is intended for installation in wall cabinets, ventilation housing units, vent flues or above kitchen islands.

- Before installing, check to make sure that the top of the appliance will be accessible once it is installed.

If this is not the case, install the exhaust ducting and prepare the mains connection **before** installation.

Installation

Installation parts

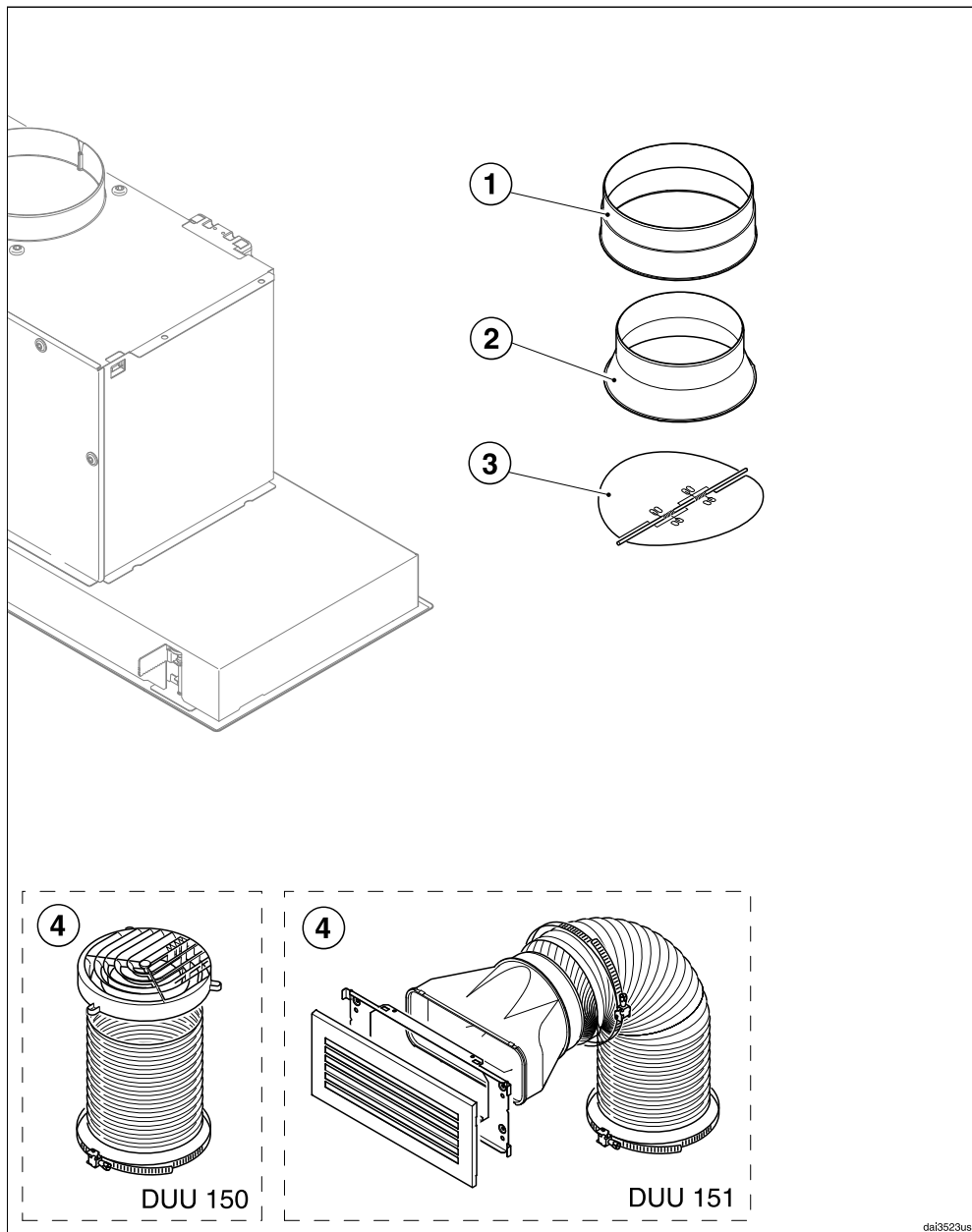

del3523us

- ① **1 collar** for exhaust ducting \varnothing 6" / 150 mm.
- ② **1 reducing collar** for exhaust ducting \varnothing 5" / 125 mm.
- ③ **1 non-return flap** for fitting into the exhaust socket on the motor unit (not needed for recirculation mode).
- ④ **Conversion kit for recirculation mode** (the conversion kit is not supplied. It must be ordered separately as an optional accessory - see "Technical data"). The kit contains an exhaust grille and flexible aluminum hose with hose clips.

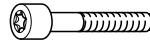

4 x M5 x 40 mm (1 5/8") screws, 4 washers, 4 x M5 nuts for securing the ventilation hood to an interim shelf.

7761730

00010689

8165620

Installation

Appliance dimensions

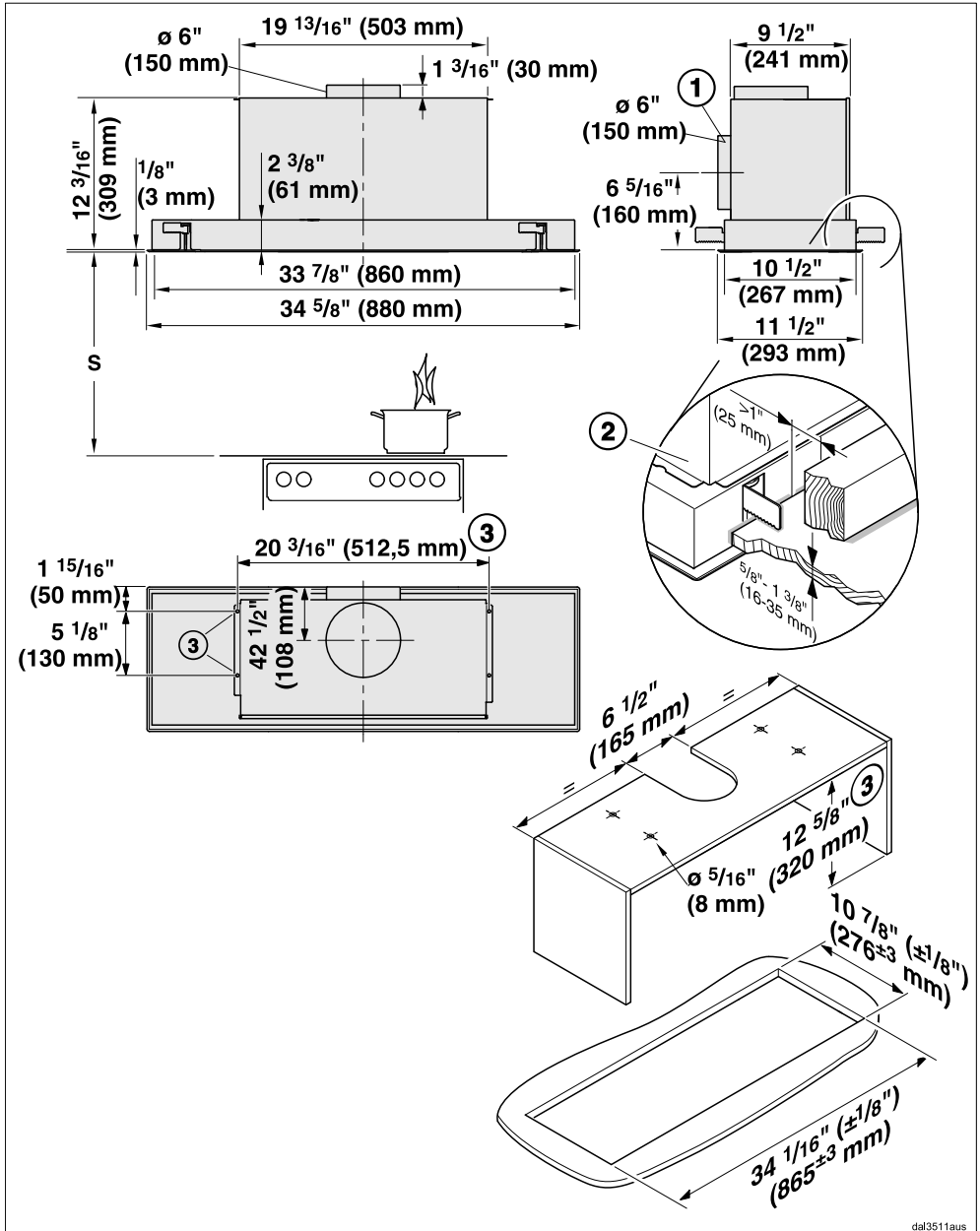

dal3511aus

- ① The ducting can also be connected at the back.
- ② The ventilation hood is secured in the cut-out by clamps. This requires that the installation surface is made of a solid material, such as wood. Make sure that the material is strong enough to bear the weight of the ventilation hood and the edge extraction panel. There must be a minimum distance of 1" / 25 mm between the areas around the clamps and any structures or components, such as struts or cables.
- ③ Alternatively, the ventilation hood can be secured to four fixing points on an interim shelf.

Installation

Distance between cooktop and ventilation hood (S)

Provided a larger distance is not given by the manufacturer of the cooktop, follow the minimum safety distances between a cooktop and the bottom of the hood.

Please also observe the information contained in the "IMPORTANT SAFETY INSTRUCTIONS" section.

Cooking appliance	Minimum distance S	
	Miele appliance	Non-Miele appliance
Electric Cooktops	24" (610 mm)	
Electric Barbeques and Fryers	26" (660 mm)	
Multiburner Gas Cooktops ≤ 43,000 BTU/hr (12.6 kW), no burner > 15,000 BTU/hr (4.5 kW).	26" (660 mm)	30" (760 mm)
Multiburner Gas Cooktops ≤ 73,800 BTU/hr (21.6 kW), no burner > 16,500 BTU/hr (4.8 kW)	30" (760 mm)	
Multiburner Gas Cooktops > 73,800 BTU/hr (21.6 kW), or one of the burners > 16,500 BTU/hr (4.8 kW)	Not possible	
Single Burner Gas Cooktops ≤ 20,500 BTU/hr (6 kW)	26" (660 mm)	30" (760 mm)
Single Burner Gas Cooktops > 20,500 BTU/hr (6 kW) ≤ 27,600 BTU/hr (8.1 kW)	30" (760 mm)	
Single Burner Gas Cooktops > 27,600 BTU/hr (8.1 kW)	Not possible	

Installation recommendations

- Please note that the greater the distance from the cooktop, the less effective the hood is at drawing in the cooking vapors.
- To achieve optimal vapor extraction, make sure that the hood covers the cooktop. The hood should be positioned centrally over the cooktop, not to the side or rear.
- The cooktop should be no wider than the hood. Preferably, it should be narrower.
- The mounting area must be easily accessible. The ventilation hood should be easy to reach and disassemble in case a service call is necessary. This should be taken into consideration when planning the position of cabinetry, shelves, ceilings or decorative elements in the vicinity of the ventilation hood.

Exhaust duct

WARNING: Danger of toxic fumes. Gas cooking appliances release carbon monoxide that can be harmful or fatal if inhaled.

To reduce the risk of fire and to properly exhaust air, the exhaust gases extracted by the hood should be vented outside of the building only.

Do not vent exhaust air into spaces within walls or ceilings or in attics, crawl spaces or garages.

To reduce the risk of fire, only use metal ductwork.

Please read and follow the "IMPORTANT SAFETY INSTRUCTIONS" to reduce the risk of personal injury. Follow all local building codes when installing the hood.

- Only use smooth pipes or flexible duct hoses made from non-flammable materials for exhaust ductwork.
- To achieve the greatest possible air extraction with the lowest noise levels, please note the following:
 - The diameter of the exhaust duct should not be less than 6" (150 mm).
 - If flat exhaust ducts are used, the cross section should not be smaller than that of the exhaust connector.
 - The exhaust duct should be as short and straight as possible.
 - If elbows are needed, make sure they have a large radius.
 - The exhaust duct itself must not be kinked or compressed.

- Make sure that all connections are secure and airtight.

Remember that any constriction of the airflow will reduce extraction performance and increase operating noise.

- If the exhaust duct is to be routed through an outside wall, we recommend installing a telescopic wall vent or a rooftop vent (available as an optional accessory).

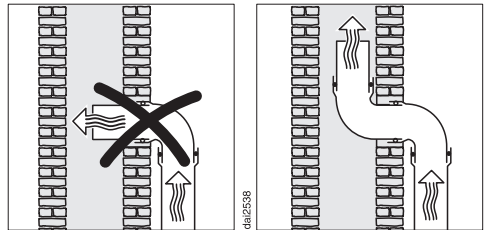

- If the exhaust air is to be conducted into a vent flue, the intake piece must be aligned with the flow direction of the flue.
- When installing the exhaust duct horizontally, you must slope it away from the source by at least $\frac{3}{8}$ " per 3' 3" (1 cm per meter). This ensures that condensate cannot drain back into the ventilation hood.
- If the exhaust duct is to be routed through rooms, ceiling space etc., the temperatures in these different areas may differ greatly, which means that the problem of condensation will need to be addressed. The exhaust duct will need to be insulated.

Reducing Collar

(optional accessory)

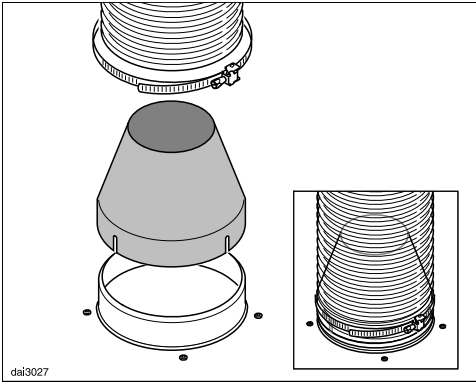

If you would like to reduce the environmental impact of your ventilation system by limiting the CFM output the Reducing Collar can be installed. It reduces the air flow to less than 400 CFM. Check local building codes for max. CFM requirements.

- Push the Reducing Collar on the exhaust port of the fan.
- Push the exhaust hose over it.
- Secure both with a hose clamp.

Electrical connection

WARNING: TO REDUCE THE RISK OF FIRE, ELECTRIC SHOCK, OR INJURY TO PERSONS, OBSERVE THE FOLLOWING:

All electrical work should be performed by a qualified electrician in strict accordance with national regulations (for USA: ANSI-NFPA 70) and local safety regulations.

Installation, repairs and other work by unqualified persons could be dangerous.

Ensure that power to the appliance is OFF while installation or repair work is performed.

Verify that the voltage, load and circuit rating information found on the data plate (located behind the baffle filters), match the household electrical supply before installing the hood.

Use only with ventilation hood cord-connection kits that have been investigated and found acceptable for use with this model hood.

If there is any question concerning the electrical connection of this appliance to your power supply, please consult a licensed electrician or call Miele's Technical Service Department.

WARNING: THIS APPLIANCE MUST BE GROUNDED

Grounding Instructions

WARNING - Improper grounding can result in a risk of electric shock.

This appliance must be grounded. In the event of an electrical short circuit, grounding reduces the risk of electric shock by providing a path of least resistance. This appliance is equipped with a cord having a grounding wire with a grounding plug.

If there is any doubt, have the electrical system of the house checked by a qualified electrician.

Do not use an extension cord. If the power supply cord is too short, have a qualified electrician install an outlet near the appliance.

- The plug must be plugged into an outlet that is properly installed and grounded.

WARNING - Grounding instructions (Canada)

The grounding-type attachment plug shall be connected to a grounding-type receptacle installed in accordance with CSA C22.1-12, Canadian Electrical Code, Part I.

Installation of the Con@ctivity 2.0 stick

In order for you to be able to use the Con@ctivity 2.0 function, the cooktop must be equipped with a Con@ctivity 2.0 stick.

- See the relevant installation instructions of the Con@ctivity 2.0 stick.

Activating the Con@ctivity 2.0 function

To use the Con@ctivity 2.0 function, the radio link between the cooktop and the ventilation hood must be activated.

Both appliances must be installed and operational.

Wireless connection must be activated on the ventilation hood and the cooktop at the same time. Activation on the ventilation hood is described below.

Activation on the cooktop is described in the relevant operating and installation instructions. Please refer to the operating instructions before starting. Activate the ventilation hood first, then the cooktop.

Activating the ventilation hood

- The cooktop and ventilation hood must be turned off.
- Press and hold the delayed shutdown button **5**  **15** for approx. 10 seconds until the **1** indicator appears in the fan level display.

- Then, press the following buttons in order:

- The – button
- Followed by the + button
- And then the lighting button .

The hood is in log on / log off mode.

If the wireless connection is activated, **2** and **3** will light up at the same time.

If there is no wireless connection, **2** and **3** will flash constantly (Con@ctivity 2.0 is already activated or a remote control is logged on).

- To activate Con@ctivity 2.0, press the "+" button.

The search for a wireless connection will start.

- As this is happening, activate the cooktop.

Activating Con@ctivity 2.0

Activating the cooktop

- **While** the ventilation hood is searching for a wireless connection, start activation on the cooktop. More information can be found in the operating instructions for the cooktop.
- When the cooktop registers that connection has been established, confirm activation on the ventilation hood with the delayed shut-down button **5**  **15**. All indicators will go out.
- Confirm activation on the cooktop.

The Con@ctivity 2.0 function is now ready for use.

If you do not confirm within 4 minutes, activation will be canceled.

You only need to carry out the activation procedure once. If the appliances are disconnected from the electricity supply, for example during a loss of power, they will still remain activated.

Activation failed

- If a wireless connection cannot be established despite activation of the Con@ctivity function on the ventilation hood and cooktop, the function must first be deactivated and then reactivated on both appliances.

Deactivating Con@ctivity 2.0

- Deactivation on the ventilation hood is carried out in the same way as activation, by selecting — instead of +.
- To deactivate the burner, please refer to the corresponding operating instructions.

Please keep in mind that disabling the connection will also disable any remote control function being used. The remote control must then be reactivated.

For faults that you cannot resolve on your own, please contact your Miele dealer or Miele Technical Service.

The telephone number for Miele is listed at the back of these instructions.

When contacting Miele, please state the model and serial number of your ventilation hood.

These can be found on the data plate.

Location of the data plate

The data plate is visible once you have removed the grease filters.

Warranty

For further information, please refer to your warranty booklet.

MieleCare

This service is available in USA only.
--

MieleCare, our Extended Service Contract program, gives you the assurance of knowing that your appliance investment is covered by 5 years of worry free ownership.

MieleCare is the only Extended Service Contract in the industry that guarantees repairs by a Miele Authorized Service Provider using genuine Miele parts. Only genuine Miele parts installed by factory trained professionals can guarantee the safety, reliability, and longevity of your Miele appliance.

Please note that unless expressly approved in writing by Miele's Service department, Extended Service Contracts offered by other providers for Miele products will not be recognized by Miele. Our goal is to prevent unauthorized (and untrained) service personnel from working on your Miele products, possibly doing further damage to them, you and/or your home.

To learn more about **MieleCare** Extended Service Contracts, please contact your appliance dealer or visit us online at:
www.mieleusa.com

Technical data

Fan motor	350 W
Overhead cooktop lighting	4 x 3 W
Total connected load	362 W
Voltage, frequency	120 V AC, 60 Hz
Fuse rating	15 A
Power cord length	2.5 ft (0.75 m)
Weight	30.8 lbs (14 kg)

Optional accessories for recirculation mode:
Charcoal filter set DKF 19-1. Contains two charcoal filters.



Contains
FCC ID: 2ACUWEI8800
IC: 5669C-EI8800

This device complies with Part 15 of the FCC Rules and with Industry Canada licence-exempt RSS standard(s). Operation is subject to the following two conditions: (1) this device may not cause harmful interference, and (2) this device must accept any interference received, including interference that may cause undesired operation.

da12491

Disposal of the packing material

The cardboard box and packing materials protect the appliance during shipping. They have been designed to be biodegradable and recyclable.

Ensure that any plastic wrappings, bags, etc. are disposed of safely and kept out of the reach of children.
Danger of suffocation!

Disposal of your old appliance

Do not dispose of this appliance with your household waste.

Old appliances may contain materials that can be recycled. Please contact your local recycling authority about the possibility of recycling these materials.

Before discarding an old appliance ensure that it presents no danger to children while being stored for disposal. Unplug it from the outlet, cut off its power cord and remove any doors to prevent hazards.

**Please have the model and serial number
of your appliance available before
contacting Technical Service.**

The Miele logo consists of the word "Miele" in a bold, white, serif font, set against a solid black rectangular background.

U.S.A.

Miele, Inc.

National Headquarters

9 Independence Way
Princeton, NJ 08540
Phone: 800-843-7231
Fax: 609-419-4298
www.mieleusa.com

Technical Service & Support Nationwide

Phone: 800-999-1360
Fax: 888-586-8056
TechnicalService@mieleusa.com

International Headquarters

Miele & Cie. KG
Carl-Miele-Straße 29
33332 Gütersloh
Germany

Canada

**Importer
Miele Limited**

Headquarters and Miele Centre

161 Four Valley Drive
Vaughan, ON L4K 4V8
www.miele.ca

Customer Care Centre

Phone: 800-565-6435
905-532-2272
customercare@miele.ca

DA 2690



en-US

M.-Nr. 10 331 580 / 02