

# Miele

## Operating and Installation Instructions

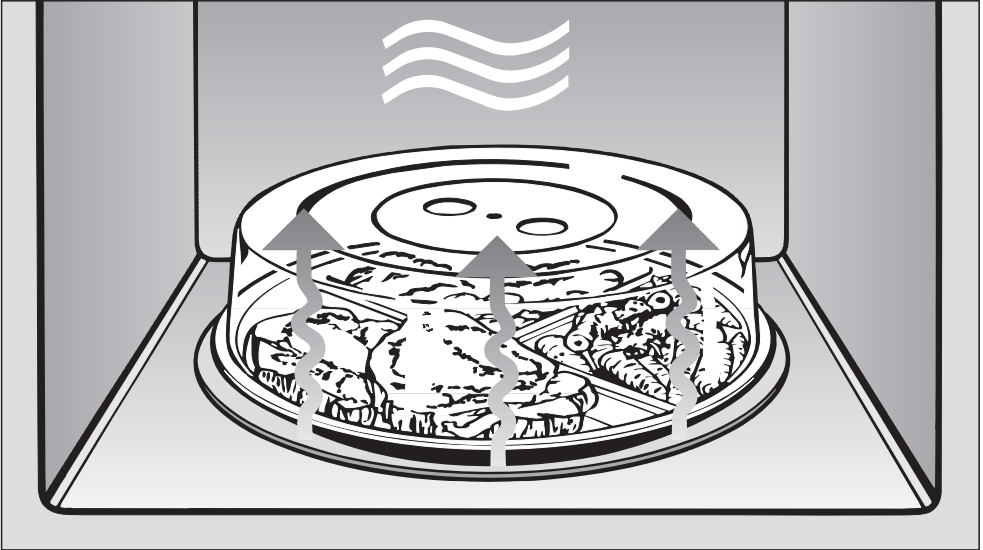

### Microwave M 8260-1

To prevent accidents  
and appliance damage  
read these instructions

**before**  
installation or use.

en - US, CA

M.-Nr. 07 372 781

# Contents

---

|   |    |
|---|----|
| <b>IMPORTANT SAFETY INSTRUCTIONS</b> . . . . .                    | 4  |
| <b>Guide to the microwave</b> . . . . .                           | 9  |
| Included accessories . . . . .                                    | 9  |
| Control panel . . . . .   | 10 |
| <b>Before the first use</b> . . . . .                             | 11 |
| <b>Selecting cookware</b> . . . . .                               | 12 |
| <b>Clock display</b> . . . . .                                    | 16 |
| Setting the time of day . . . . .                                 | 16 |
| Changing the time of day . . . . .                                | 16 |
| Turning Off / On the display . . . . .                            | 16 |
| Overnight turn-off . . . . .                                      | 16 |
| <b>Use</b> . . . . .  | 17 |
| Starting a program . . . . .                                      | 17 |
| Interrupting / Re-starting a program . . . . .                    | 19 |
| Changing the settings . . . . .                                   | 19 |
| Canceling a program . . . . .                                     | 19 |
| At the end of a program . . . . .                                 | 19 |
| Warming function . . . . .  | 19 |
| Quick-Start . . . . .   | 20 |
| System lock . . . . .   | 20 |
| Timer . . . . .   | 21 |
| <b>Automatic programs</b> . . . . .                               | 22 |
| Automatic defrosting . . . . .                                    | 22 |
| Automatic cooking . . . . .                                       | 22 |
| <b>Reheating</b> . . . . .  | 24 |
| <b>Cooking</b> . . . . .  | 25 |
| <b>Defrosting / Defrosting and reheating or cooking</b> . . . . . | 26 |
| <b>Suggested uses</b> . . . . .                                   | 27 |
| <b>Favorites</b> . . . . .  | 28 |
| <b>Settings</b> . . . . .   | 30 |
| Settings table . . . . .  | 31 |

|   |    |
|---|----|
| <b>Cleaning and Care</b> .....                  | 32 |
| Microwave interior and inside of the door ..... | 32 |
| Appliance front .....                           | 33 |
| Accessories .....                               | 33 |
| <b>Frequently asked questions</b> .....         | 34 |
| <b>Technical Service</b> .....                  | 37 |
| <b>Installation instructions</b> .....          | 39 |
| <b>Caring for the environment</b> .....         | 40 |
| Disposal of the packing materials .....         | 40 |
| Disposal of an old appliance .....              | 40 |
| <b>Electrical connection</b> .....              | 41 |
| <b>Installation</b> .....                       | 42 |
| Building-in dimensions .....                    | 42 |

# IMPORTANT SAFETY INSTRUCTIONS

**When using electrical appliances always observe basic safety precautions, including the following:**

WARNING - To reduce the risk of burns, electric shock, fire, injury to persons, or exposure to excessive microwave energy:

Read all instructions before installing or using the oven.

Read and follow the specific, "PRECAUTIONS TO AVOID POSSIBLE EXPOSURE TO EXCESSIVE MICROWAVE ENERGY" in the "IMPORTANT SAFETY INSTRUCTIONS" section of this manual.

This appliance is intended for residential use only. Only use the appliance for its intended purpose.

Install or locate this appliance only in accordance with the provided installation instructions.

This appliance complies with current safety requirements. Improper use of the appliance can lead to personal injury and material damage.

▶ To reduce the risk of fire in the oven cavity:

i) Do not overcook food. Carefully attend appliance when paper, plastic or other combustible materials are placed inside the oven to facilitate cooking.

ii) Remove wire twist-ties from paper or plastic bags before placing bag in oven.

iii) If materials inside the oven ignite, keep the oven door closed, turn oven off, and disconnect the power cord, or shut off power at the fuse or circuit breaker panel.

iv) Do not use the cavity for storage purposes. Do not leave paper products, cooking utensils or food in the cavity when not in use.

## Correct usage

▶ The appliance is intended for domestic use only: defrosting, heating and cooking of food.

It is not designed for industrial or laboratory use.

▶ Do not use corrosive chemicals or vapors in this appliance.

▶ Do not use the appliance to store or dehydrate flammable materials. This is a fire hazard.

▶ Persons who lack physical, sensory or mental abilities, or experience with the appliance should not use it without supervision or instruction by a responsible person.

# IMPORTANT SAFETY INSTRUCTIONS

---

## Children

▶ As with any appliance, close supervision is necessary when used by children.

## Technical safety

▶ Installation, repair and maintenance work should be performed by a Miele authorized service technician in accordance with national and local safety regulations and the provided installation instructions. Contact Miele's Technical Service Department for examination, repair or adjustment.

▶ Before installation make sure that the voltage and frequency listed on the data plate correspond with the household electrical supply. This data must correspond in order to prevent injury and machine damage. If in doubt, consult a qualified technician.

▶ To guarantee the electrical safety of this appliance, continuity must exist between the appliance and an effective grounding system. This appliance must be grounded. Connect only to properly grounded outlet. See "Electrical connection - GROUNDING INSTRUCTIONS". It is imperative that this basic safety requirement be met. If there is any doubt, have the electrical system of the house checked by a qualified electrician.

▶ The appliance must only be operated after it has been correctly installed into cabinetry. This is necessary to ensure that all electrical components are shielded.

▶ Before installing the oven, check for externally visible damage. **Do not** operate a damaged appliance.

▶ This appliance must not be installed or operated outdoors.

▶ Do not use this product near water – for example, near a kitchen sink, in a wet basement, near a swimming pool, or similar locations.

▶ Do not mount over a sink.

▶ Do not store anything directly on top of the appliance surface when the appliance is in operation.

▶ Defective components should be replaced by Miele original spare parts only. Only with these parts can the manufacturer guarantee the safety of the appliance.

▶ This appliance is not designed for maritime use or for use in mobile installations such as recreational vehicles or aircraft. However, under certain conditions it may be possible for installation in these applications. Please contact the Miele Technical Service Department with specific requirements.

▶ Before service or maintenance work the power supply must be disconnected.

# IMPORTANT SAFETY INSTRUCTIONS

▶ Do not operate any appliance with a damaged cord or plug, or if the appliance has been damaged in any manner. Contact Miele's Technical Service Department.

▶ Do not use an extension cord to connect this appliance to electricity. Extension cords do not guarantee the required safety of the appliance.

▶ Do not open the casing of the oven. Danger of electric shock!

## **PRECAUTIONS TO AVOID POSSIBLE EXPOSURE TO EXCESSIVE MICROWAVE ENERGY**

Do not attempt to operate this oven with the door open since open-door operation can result in harmful exposure to microwave energy. It is important not to damage or tamper with the safety interlocks.

Do not place any object between the oven front and the door or allow soil or cleaner residue to accumulate on sealing surfaces.

Do not operate the oven if it is damaged. It is particularly important that the oven door closes properly and that there is no damage to the: (1) door (bent), (2) hinges and latches (broken or loosened), (3) door seals and sealing surfaces.

The oven should not be adjusted or repaired by anyone except properly qualified service personnel.

## **Safety**

▶ Do not use the oven to heat the room. Due to the high temperatures radiated, objects left near the oven could catch fire.

▶ Do not submerge the cord or plug in water.

▶ Keep the power cord away from heated surfaces.

▶ Do not let the cord hang over the edge of a table or counter.

▶ Do not cover or block any openings on the appliance.

▶ Times for cooking, heating and defrosting food in the microwave are shorter than that of traditional food preparation methods. Extensive microwaving could dry out food and cause possible ignition. Fire hazard!

▶ Do not heat cushions filled with herbs, gel, etc. with the microwave function. The cushions could ignite, even once removed from the oven after heating. This is a fire hazard.

▶ Do not use full power to warm empty dishes or dry herbs.

▶ Do not heat an empty microwave.

▶ Do not use the appliance for dehydrating food, or leave it unattended when cooking with oils and fats. Fire hazard.

▶ Never heat undiluted alcohol in the microwave oven, it can easily ignite.

# IMPORTANT SAFETY INSTRUCTIONS

---

- ▶ If materials inside the oven ignite, keep the oven door closed to avoid fueling any flames. Turn the oven off or disconnect the power supply.
- ▶ Cover food that is left in the microwave to stay warm. Otherwise moisture from the food could damage the machine. This will also prevent the food from drying out.
- ▶ Spills or stains from food and liquids containing salt should be immediately cleaned from the stainless steel interior. Corrosion may occur.
- ▶ If smoke occurs in the oven, to avoid fueling any flame, do not open the oven door. Switch the appliance off by pressing the Stop/C button, switch off at the mains and remove the plug from the socket. Do not open the oven door until the smoke has dispersed.
- ▶ Do not use a steam cleaner to clean this appliance. The steam could penetrate live components and permanently damage the oven or cause injury.
- ▶ When cleaning surfaces of the door and oven that come together when the door is closed, use only mild, non-abrasive soaps, or detergents applied with a sponge or soft cloth.
- ▶ Do not operate the microwave empty. This will cause damage.
- ▶ Do not use items containing metal, aluminum foil, cutlery, dishware with metal decoration, crystal glass containing lead, bowls with a knurled rim, non-temperature safe dishware, wooden dishware, metal clips, wire twist ties, food containers with metal coverings or residues.  
Danger of machine damage and fire.
- ▶ Do not leave the appliance unattended when heating food in disposable, e.g. plastic, paper or other flammable materials.
- ▶ Do not use the oven to heat food in heat retaining packaging, e.g. take-out food bags.  
This packaging contains a thin layer of aluminum foil which reflects the microwaves. This reflected energy can cause the paper layer to ignite.
- ▶ Before serving food allow a sufficient standing time. Always check the temperature of the food itself after taking it out of the microwave. Do not judge by the plate temperature. The heat is created in the food, the dishes may stay cool to the touch.
- ▶ Always check the temperature before serving heated baby food.
- ▶ Use a food thermometer to measure the foods temperature. Do not use thermometers containing mercury or liquids, they are not suitable for high temperatures and break easily.
- ▶ Never cook or reheat food and liquids in sealed containers or bottles. Remove the nipple or lid before heating in the microwave. Built-up pressure may cause them to burst. Danger of injuries.

# IMPORTANT SAFETY INSTRUCTIONS

---

▶ When heating liquids, the provided boiling wand should be placed into the container.

Liquids, such as water, coffee, or tea are able to be overheated beyond the boiling point without appearing to be boiling. Visible bubbling or boiling when the container is removed from the microwave oven is not always present. THIS COULD RESULT IN VERY HOT LIQUIDS SUDDENLY BOILING OVER WHEN THE CONTAINER IS DISTURBED OR A UTENSIL IS INSERTED INTO THE LIQUID.

The built-up pressure may force the oven door open. This could result in injury or damage. The boiling wand ensures that the liquid boils evenly and that steam bubbles form at an early stage.

▶ Some products such as whole eggs and sealed containers - for example, closed glass jars - are able to explode and should not be heated in this oven.

▶ Eggs can be cooked without their shells in the microwave oven only if the yolk membrane has been punctured first. The pressure could otherwise cause the egg yolk to explode. Danger of injuries.

▶ Do not heat closed containers in the microwave oven. They may burst.

▶ Food with a thick skin or peel, such as tomatoes, sausages and potatoes should be pierced in several places before cooking to allow steam to vent and prevent the food from bursting.

▶ Always ensure that the turntable is in place before turning on the microwave.

▶ Do not heat dishware with hollow handles or lid knobs. Moisture can get into the hollow parts. (The hollow parts of some dishware can be vented). Danger of built-up pressure and the explosion of the hollow parts may cause injuries.

**SAVE THESE INSTRUCTIONS  
AND REVIEW THEM  
PERIODICALLY**



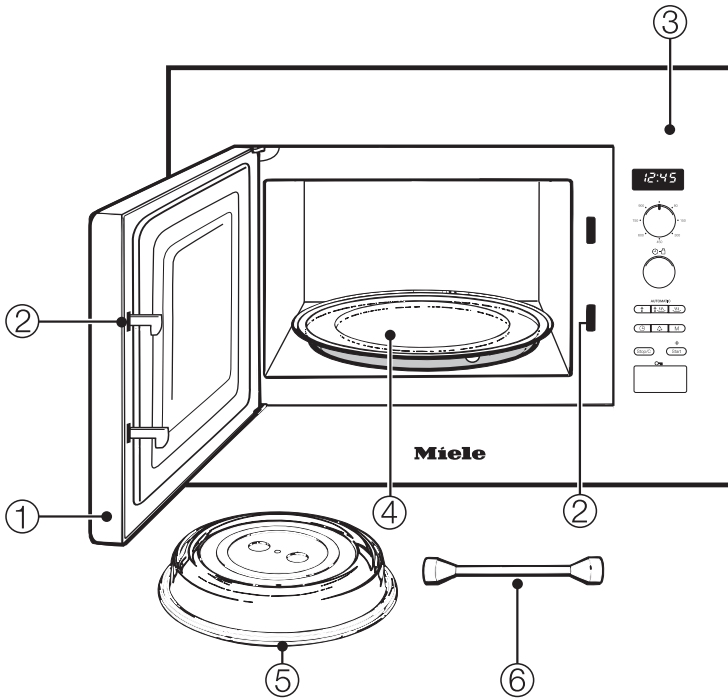

- ① Microwave door
- ② Door lock
- ③ Control panel
- ④ Turntable
- ⑤ Cover
- ⑥ Boiling wand

## Included accessories

### Cover

The cover prevents food from drying out, shortens and evens out the cooking process, and prevents soiling of the microwave interior.

### Boiling wand

When heating liquids, the provided boiling wand should be placed into the container. It helps in even boiling of the liquid.

# Guide to the microwave

## Control panel

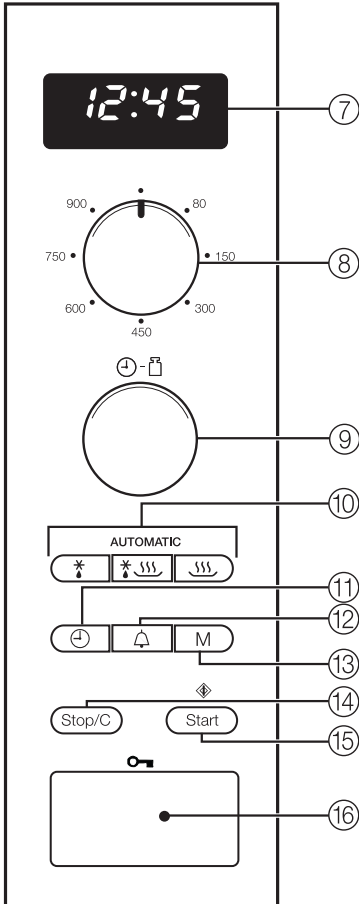

- ⑦ Timer and 24 hour clock display
- ⑧ Power selector
- ⑨ Time and weight selector
- ⑩ Automatic program buttons
- ⑪ Time of day ⊕ button
- ⑫ Timer ▲ button
- ⑬ Memory button  
(to save a favorite 1 - 3 stage  
program sequence)
- ⑭ Stop/Cancel button
- ⑮ Start button / Add a minute button /  
Quick start button ◆
- ⑯ Door open 🔑 button

## Before the first use

Allow the microwave to sit unpacked for approx. 2 hours after transport before connecting to the power supply.

This is important for the electronic functioning of the appliance.

- Remove all protective packaging and foil from the appliance.

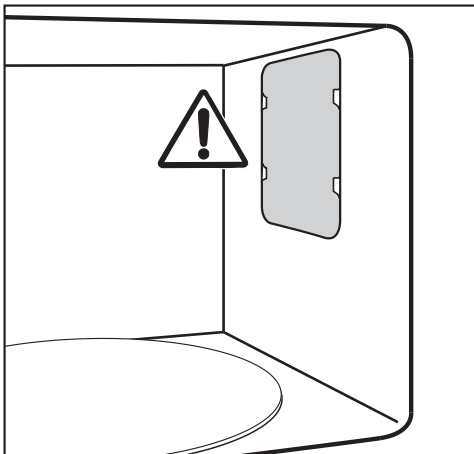

Do not remove the protective film from the inside of the door, or the cover to the outlet inside the microwave.

- Check the appliance for any visible damage.

Do not operate the microwave if it is damaged. It is particularly important that the microwave door closes properly and that there is no damage to the: (1) door (bent), (2) hinges and latches (broken or loosened), (3) door seals and sealing surfaces.

- Clean the interior of the microwave and all accessories with a mild solution of warm water and liquid dish soap. Dry with a soft cloth.

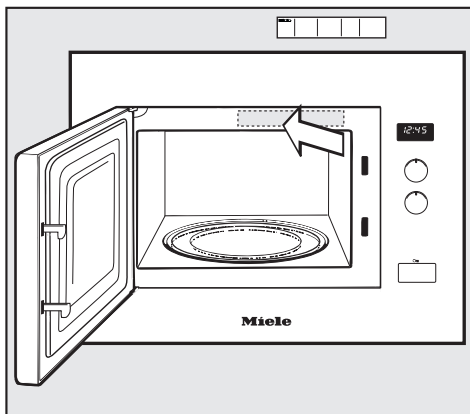

- Stick the included short instructions to the frame behind the door (as shown). Be sure not to block the vents.

# Selecting cookware

Microwaves:

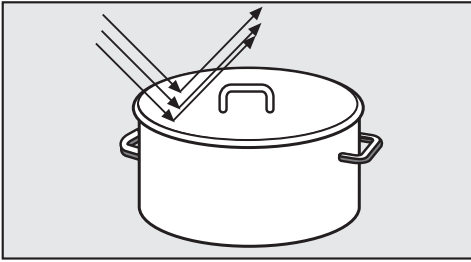

– are reflected by metal,

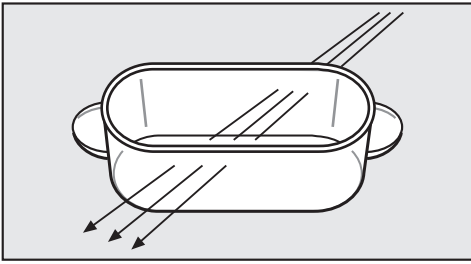

– pass through glass and chinaware,

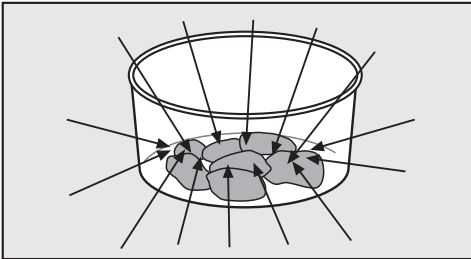

– are absorbed by the food.

## Material and shape

The material and shape of containers used affect cooking results and times. Circular and oval containers work best. The food will heat more evenly than in a square container.

Container and lids which contain hollow handles or knobs are not suitable for use in the microwave. The handles or knobs could collect moisture if not adequately vented. Without vent holes pressure can build up, causing the container to crack or shatter, danger of injury.

## Metal

 Do not use metal containers, aluminum foil, cutlery or dishes with metal decor in the microwave.

The metal reflects the microwaves which can damage the microwave.

# Selecting cookware

## Exceptions:

- Pre-cooked meals in aluminum foil containers can be defrosted and reheated in the microwave, if recommended by the manufacturer.  
**Important:** Remove the lid before heating the food.  
The food is heated only from above.  
To heat the food evenly place it in a container suitable for microwaving.

Make sure that the aluminum foil is at least 1 inch (2.5 cm) from the microwave walls at all times. It **must not** touch the walls.

- For even defrosting and to avoid overcooking unevenly shaped cuts of meat, poultry or fish, small pieces of aluminum foil may be used to mask wing-tips or other thin parts for the last few minutes of the process.
- Metal meat skewers or clamps should only be used if they are small in comparison to the size of the meat.

## Glassware

Heat-resistant glass or ceramic glassware are ideal for use in the microwave.

Crystal contains lead and is unsuitable.

## Porcelain (china)

Porcelain (china) is suitable for use in the microwave.

Do not use porcelain with gold or silver edging or items with hollow knobs or handles, insufficient ventilation may cause damage.

## Earthenware

Decorated earthenware is only suitable if the decoration is beneath the glaze.

Earthenware can get very hot and may crack.

## Glazes and colors

Some glazes and colors contain metallic substances. They are not suitable for the microwave.

## Wood

Wood containers are not suitable. The water from the wood evaporates during the cooking process causing it to dry out and crack.

# Selecting cookware

---

## Plastic

When purchasing plasticware, be sure it is suitable for use in a microwave. It must be heat resistant up to 230°F (110°C) otherwise the plastic may melt into the food. Otherwise the plastic may melt.

Special plasticware, designed for use in microwaves is available in retail outlets.

Plastic boiling bags can be used for cooking and reheating. They should be pierced beforehand so that steam can escape. This prevents a build-up of pressure and reduces the risk of the bag bursting.

Do not use metal clips, plastic clips with metal parts, or twist ties containing wire. They could ignite when heated.

## Disposable containers

Only those plastic disposable containers specified under "Plastics" are suitable for use in the microwave.

Do not leave the microwave unattended when reheating or cooking food in disposable containers made of plastic, paper or other flammable materials.

Disposable containers are not always microwave safe.

### Covering the food

Plastics are only heat-resistant up to 230°F (110°C). Higher temperatures can cause the cover to melt into the food.

The cover should not completely seal the container. This may prevent steam from escaping causing the cover to melt.

#### The cover:

- prevents most of the steam from escaping, especially when cooking foods which needs longer to cook, such as potatoes.
- shortens and evens out the cooking process.
- prevents the food from drying out.
- prevents soiling of the microwave interior.

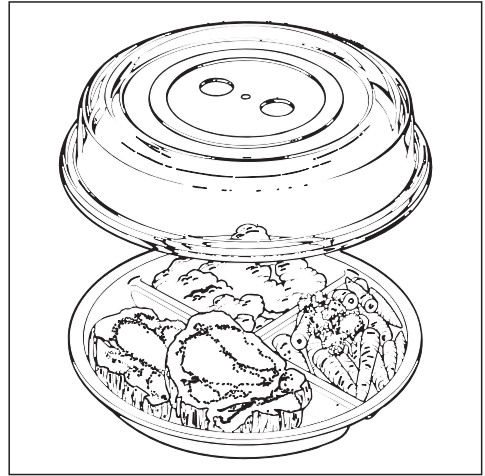

- Always cover food with the supplied cover.

A glass or plastic lid is also suitable as an alternative for microwaves. Available in retail stores.

Plastic wrap suitable for microwaving can also be used.

Do not heat food in closed containers e.g. glass baby food containers. Vent the container before heating.

**Do not use a cover if** cooking food in which a crisp finish is desired e.g. breaded chicken, garlic bread, etc.

# Clock display

---

## Setting the time of day

- Connect the appliance to the electrical supply.  
12:00 and the ⊖ symbol will flash in the display until the time of day is set. As soon as the microwave is connected to the electrical supply the clock will begin counting upwards until the time is set.

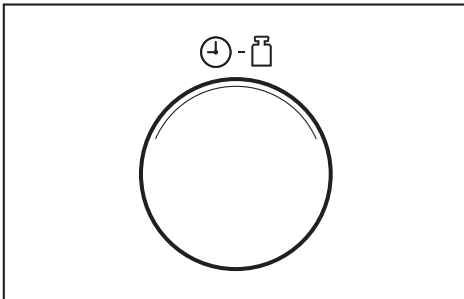

- Turn the "Time selector" to set the hour.
- Press ⊖ to confirm the selection.
- Turn the "Time selector" to set the minutes.
- Press ⊖ to confirm the selection, or wait a few seconds.  
The time set is now saved. The colon between the hours and minutes flashes.

## Changing the time of day

- Press ⊖. The ⊖ symbol will flash in the display, and the current hour will light up for a few seconds.
- Change the hour as desired using the time selector.
- Press ⊖ to confirm the selection, or wait a few seconds.  
The ⊖ symbol will flash and the current minutes will light up for a few seconds.
- Set the minutes using the time selector.
- Press ⊖ to confirm the selection, or wait a few seconds.

## Turning Off / On the display

- **To turn the display off**, press and hold ⊖ until the display goes dark.
- **To turn the display on**, press and hold ⊖ until the time of day appears in the display.

## Overnight turn-off

If desired, the display can be set to turn itself off from 23:00 to 04:00 o'clock.

- **To turn off:** press and hold "Stop/C", at the same time press ⊖.  
*ON* appears in the display.  
The microwave can still be operated as normal.
- **To turn on:** press and hold "Stop/C", at the same time press ⊖.  
*OFF* appears in the display.



## Opening the door

- Press "🔑" to open the door.

If the microwave is in use, opening the door will interrupt the program.

## Placing dish in microwave

- Place the dish in the middle of the microwave on the turntable.

Do not place food directly on the turntable.

Be sure that the dish used is not larger than the turntable

Do not use the microwave without the turntable in place.

The **turntable** helps the food cook, reheat or defrost evenly.

As soon as a program is started the turntable will begin to turn automatically.

## Closing the door

- Push the door shut.
- Press the "Start" button to restart the interrupted cooking program.

The program will not start if the door is not closed properly.

## Starting a program

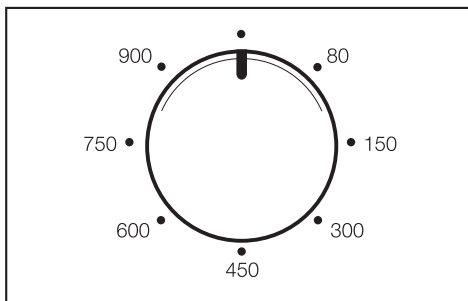

- Use the "Power selector" to choose the desired power level  
The ☰ symbol lights up and 0:00 flashes in the display.

There are **seven microwave power levels** available. A higher number indicates increased power.

# Use

When heating food which cannot be stirred or turned, it is best to use a lower power level.

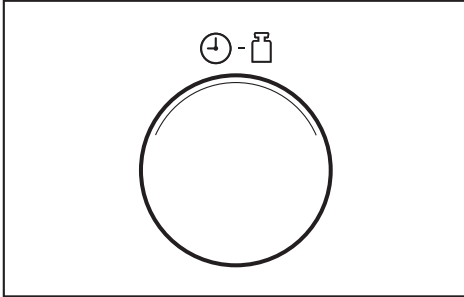

- Set the desired time using the "Time selector".

A time between 10 seconds and 90 minutes can be set.

**Exception:** If the maximum power level is selected a max. cooking time of 15 minutes can be set. If the max. power level is continuously selected the power level may reduce to 600 W, to protect against overheating.

When selecting a time consider the following:

- the initial temperature of the food,
- the type and texture of the food.
- the frequency of stirring or turning of the food.
- the amount of food.
- the type and material of the dish.

- Press the "Start" button to begin the program.

The program will only start if the door is closed properly.

## "door"warning

If the door has been closed for 20 minutes or longer when the "Start" button is pressed, the word "door" will appear in the display. The "door" message acts as a reminder that the appliance should not be used without food inside it.

- Open the door to make sure food is in the microwave before pressing "Start".  
The program will not start until you do this.

Operating the microwave without food can cause damage.

## Interrupting / Re-starting a program

- **To interrupt a program**, press the "Stop/C" button, or open the microwave door.
- **To re-start a program**, close the door and press "Start".

The program continues.

## Changing the settings

To select a new power level:

- Interrupt the program by pressing the "Stop/C" button once.
- Set a new time using the "Time selector".
- Continue the program by pressing "Start".

To increase the cooking duration:

- Press the "Start" button during operation. Each press increases the cooking time by one minute.

**Exception:** If the microwave is being used at the max. power level the cooking time will increase by 30 seconds with each press of the "Start" button.

## Canceling a program

- Press the "Stop/C" button twice.

## At the end of a program

A signal will sound indicating that the cooking program is complete. The interior lighting goes out.

The signal will sound briefly as a reminder every 5 minutes for 20 minutes after the end of the program.

- To cancel the signal, press "Stop/C".

## Warming function

If the door remains closed and no buttons are pressed for approx. 2 minutes after the program (450 W or higher) has ended, the warming function will turn on.

The warming function turns the microwave on at 80 W for a max. of 15 minutes.

 80 W and **H:H** appear in the display.

If the door is opened or a button is pressed during the warming function, the function will be canceled.

The warming function cannot be used as a separate function.

# Use

---

## Quick-Start

Press "Start /🔑" to begin the microwave operating at maximum power.

Three times are stored in memory:

- 30 secs: Press "Start /🔑" once
- 1 min: Press "Start /🔑" twice
- 2 min: Press "Start /🔑" three times

Pressing "Start /🔑" 4 times will return you to the first stored time.

While in operation the cooking duration can be increased by pressing the "Start" button. Each press of the "Start" button increases the cooking time by 30 seconds.

## Reprogramming the set times:

- Press "Start /🔑" to select the time you would like to reprogram (press 1, 2 or 3 times), and hold in the "Start /🔑" button.
- While holding in the "Start" button, use the "Time selector" (max. 15 minutes) to reprogram the time. When the "Start /🔑" button is released the reprogrammed time will run.

If a power failure occurs the reprogrammed times will need to be reset.

## System lock

The microwave can be locked to prevent misuse.

### To activate:

- Press and hold "Stop/C" until a signal is heard and the key symbol appears in the display.

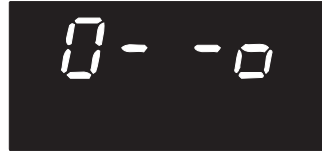

The key symbol will go out after a few seconds.

The symbol will reappear whenever a button is pressed or a selector is turned.

If a power failure occurs the system lock will need to be reactivated.

### To deactivate:

- Press and hold "Stop/C" until a signal is heard.

## Timer

The timer can be used to time any activity in the kitchen.

- Press "△".  
0:00 flashes in the display, and "△" lights up.
- Using the "Time selector" set the desired time.
- Press "Start" to start the timer.  
If "Start" is not pressed the timer will begin on its own after a few seconds.
- When the set time has elapsed a signal is heard. The time of day appears in the display and "△" flashes.
- Press "Stop/C" and "△" goes out.

## Reprogramming the timer

- Press "Stop/C".  
The timer is interrupted.
- Set a new timer duration using the method described above.

## Timer with cooking program

The timer can be used at the same time as a cooking program by counting down in the background.

- Press "△" while the program is in progress.  
0:00 flashes in the display and "△" lights up.
- Using the "Time selector" set the timer duration desired.
- The timer will begin counting down after a few seconds.  
A few seconds later the display will change to show the cooking duration counting down. The timer is indicated with the "△" symbol.

Do not use the "Start" button to begin the timer, this will increase the cooking duration by one minute.

## Timer duration remaining

- Press "△".  
The timer duration remaining will appear in the display.

## Automatic programs

---

All automatic programs are weight dependent.

The weight can be displayed in either pounds (lb) or grams (g), see "Settings".

Once a program is selected, enter the weight of the food. The microwave then automatically calculated the time according to the weight entered.

When cooking is complete, allow the food to stand at room temperature for the suggested "standing time" to allow the heat to distribute evenly throughout the food.

### Automatic defrosting

Five programs are available for defrosting different types of food (✱).

The recommended "standing time" for Ad 3 is up to 30 minutes depending on the weight. Approx. 10 minutes is recommended for the remaining programs.

Ad 1  Steak, cutlets  
(0.5 – 2.2 lb)/(200 – 1000 g)

Ad 2  Ground meat  
(0.5 – 2.2 lb)/(200 – 1000 g)

Ad 3  Chicken  
(2.0 – 4.0 lb)/(900 – 1800 g)

Ad 4  Cakes  
(0.3 – 3.1 lb)/(100 – 1400 g)

Ad 5  Bread  
(0.5 – 2.2 lb)/(200 – 1000 g)

### Automatic cooking

Three programs are available for frozen and fresh food.

The recommended "standing time" for these programs is approx. 2 minutes.

#### Cooking frozen food ✱

AC 1  Vegetables  
(0.3 – 1.3 lb)/(100 – 600 g)

AC 2  Frozen dinner (can be stirred)  
(0.7 – 2.2 lb)/(300 – 1000 g)

AC 3  Casseroles  
(0.5 – 1.3 lb)/(200 – 600 g)

#### Cooking fresh food

AC 1  Vegetables  
(0.3 – 1.3 lb)/(100 – 600 g)

AC 2  Potatoes  
(0.3 – 1.7 lb)/(100 – 800 g)

AC 3  Fish  
(1.2 – 3.3 lb)/(500 – 1500 g)

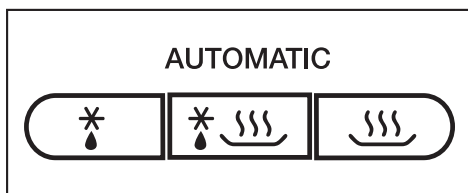

- Press the relevant button until the desired program appears in the display.  
**Example:** To select program Ad 3  (defrosting chicken) press "\*" three times.

lb or g will flash in the display, and the selected program will light up along with the Microwave symbol .

- If desired press "M", to toggle between the lb and g settings.
- Enter the weight using the "Weight selector".
- Press "Start".

The cooking duration, which was calculated according to the weight entered, will begin to count down and the Microwave symbol  will light up.

A signal will sound halfway through the cooking time.

- Interrupt the program to turn or stir the food then continue the program.

If desired the time can be extended by a few minutes during operating by pressing the "Start" button repeatedly until the desired time shows in the display.

It is only possible to extend the time by a few minutes.

A signal will sound when the program is complete, and the interior lighting of the microwave will go out.

# Reheating

---

To reheat food/drinks select the following power levels:

- Drinks. . . . . 900 Watts
- Food. . . . . 600 Watts
- Food for babies/toddlers . . . 450 Watts

Take care that baby/toddler food is at a safe temperature when served. Heat for only for 30 seconds at a time then check temperature.

## Reheating tips

- Use a lid or cover for reheating food, except when a "drier" finish is needed, e.g. breaded foods.
- Remove the lid from glass containers e.g. baby food jars.
- Remove the lid or nipple from baby bottles before heating.
- To heat a liquid, insert the boiling wand into the container.

Do not reheat hard boiled eggs, even without the shell, in the microwave. The eggs can burst.

- Stir or turn food from time to time to ensure even reheating.

## After reheating

Be careful when removing a dish from the microwave, it may be hot.

- After reheating food, especially food for babies and small children, stir the food or shake the container and check that the temperature does not pose any danger.



Place food in a microwave-safe dish and cover.

When cooking it is recommended to select a power level of 900 W to begin with, and once the food is hot reduce the power to 450 W for more gentle cooking.

For dishes such as rice or oatmeal, first select a power level of 900 W then reduce to 150 W for simmering.

## Cooking tips

- Add a little water when cooking vegetables that are not fresh in the microwave. Fresh vegetables cook quicker.
- Food from the fridge needs a longer cooking time than food at room temperature.
- Stir or turn food during cooking to help it cook more evenly.
- Food with a thick skin or peel, such as potatoes and sausage, should be pierced several times before cooking to allow steam to vent and prevent the food from bursting.
- Eggs can be cooked without their shells in the microwave only if the yolk has been punctured. The pressure could otherwise cause the egg yolk to explode.

## After cooking

Be careful when removing a dish from the microwave, it may be hot.

# Defrosting / Defrosting and reheating or cooking

---

## Defrosting

The following microwave power levels are recommended for defrosting:

- 80 W  
for defrosting delicate food such as heavy cream, butter, cheese, etc.
- 150 W  
for defrosting all other foods.
- Take the frozen food from the packaging and put it in a microwave safe container. Do not cover. Turn, stir or separate food about halfway through the defrosting time.

## Defrosting tips

- Fish does not need to be fully defrosted before cooking. Defrost it so that the surface is soft enough to adhere seasoning and herbs.
- Turn meat halfway through defrosting.

## Defrosting followed by reheating or cooking

Deep-frozen food can be defrosted and then immediately reheated or cooked.

- After defrosting, select 900 W followed by 450 W.

Remove food from its packaging and place in a covered microwave-safe dish. Exception: ground meat should be left uncovered.

## Tips

- Soups, stew and vegetables should be stirred several times during the process.
- Carefully separate and turn slices of meat/fish halfway through the program.

## After defrosting followed by reheating or cooking

After defrosting allow the food to stand at room temperature long enough to distribute the heat evenly throughout the food.

## Suggested uses

| Food type                   | Quantity                                      | Power level (Watt) | Time (min:sec) | Additional info   |
|-----------------------------|---|--------------------|----------------|---|
| Melting butter or margarine | 1/4 lb (100 g)                                | 450                | 1:00 – 1:10    | Do not cover.   |
| Melting chocolate           | 1/4 lb (100 g)                                | 450                | 3:00 – 3:30    | Do not cover.<br>Stir halfway through.  |
| Dissolving gelatine         | 1 packet + 5 T water                          | 450                | 0:10 – 0:30    | Do not cover.<br>Stir halfway through.  |
| Preparing glazes            | 1 packet + 1 cup liquid (250 ml)              | 450                | 4 – 5          | Do not cover.<br>Stir halfway through.  |
| Yeast dough                 | Made with 1/2 cup (100 g) flour               | 80                 | 3 – 5          | Cover and leave to proof.   |
| Popcorn                     | 1 T (20 g) popcorn kernels                    | 900                | 3 – 4          | Place popcorn in 1 liter container, cover and cook.   |
| Salad dressings             | 1/2 cup (125 ml)                              | 150                | 1 – 2          | Heat uncovered.   |
| Tempering citrus fruits     | 3/4 cup (150 g)                               | 150                | 1 – 2          | Place on a plate, do not cover.   |
| Bacon                       | 1/4 lb (100 g)                                | 900                | 2 – 3          | Place on a paper towel, do not cover.   |
| Softening ice cream         | 1/2 gallon (500 g)                            | 150                | 2              | Place open ice cream container in microwave.  |
| Warming plates              | 4 plates                                      | 900                | 2 – 3          | Do not heat plates with metal decor.  |
| Skinning tomatoes           | 3 tomatoes                                    | 450                | 6 – 7          | Cut a cross shape into the top of each tomato, cover and heat in a little water. Use caution, the tomatoes may get hot. |
| Strawberry jam              | 1 lb strawberries<br>1 1/2 cups (300 g) sugar | 900                | 7 – 9          | Mix fruit and sugar, cover and cook.  |

**This information is intended only as a guide.**

## Favorites

One favorite program can be saved into memory (e.g. your most frequently used program).

The program can incorporate up to 3 stages (e.g. 2 minutes at 600 W, followed by 10 minutes at 450 W, followed by 3 minutes at 300 W).

### Programming

(This is an example to set a 3 stage program.)

- Select the power level for the first stage.
- Select the duration.

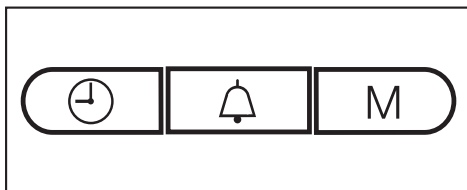

- Press "M".  
1 will light up in the display, and 2 will flash.
- Select the power level and duration for the second stage.
- Press "M" again.  
2 will light up in the display, and 3 will flash.
- Select the power level and duration for the third stage. Press the "M" button.

Once the third stage is complete you can use the "M" button to scroll through your entry to confirm that everything is correct.

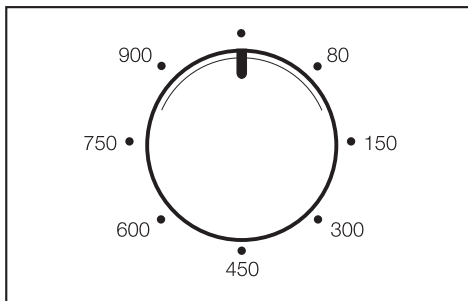

- Once you have finished the programming, turn the "Power selector" to the 12 o'clock position.
- To save the entry start the program.  
**Do not** run the entire program unless food is in the microwave.

If there is no food in the appliance press the "Stop/C" button twice once the program starts.

1 and 2 stage programs can be programmed and saved in the same way. The programming process is complete when the "Program selector" is in the 12 o'clock position and the "Start" button has been pressed, while pressing the "M" button shows the next stage.

### Changing an entry

- Once a new program has been entered the previously saved program is overridden.

## Using the "favorite" program

- Turn the program selector to the 12 o'clock position.
- Press "M".

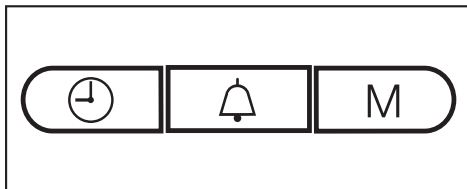

- Press "Start".

If a power failure occurs the programmed favorite is no longer saved and will need to be reset.

## Settings

---

The default microwave settings can be changed, if desired, to suit your preferences.

See the table on the following page for the different settings available.

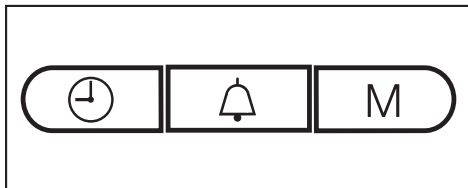

- Press and hold "⌚" and "M" at the same time until **P 1** and "🔔" light up in the display, then release them both. If they are pressed for too long the time of day will appear in the display.
- Using the "Time selector" select the setting you would like to change (**P 0** to **P 5**).
- Press "M" to call up the setting. **5** will appear in the display to show that the setting can be changed.

- Turn the "Time selector" if you wish to change the setting (see Table), confirm the selection by pressing "M" (for **P 5** and **P 0** press and hold "M" for approx. 4 seconds).

The change is now saved. **P** will appear in the display again, together with the setting number.

All settings can be changed in the same way.

- When you are done making changes to the settings press "Stop/C".

The changed settings are saved during a power failure.

## Settings table

| Setting    |   | Available settings (* factory default) |   |
|------------|---|--|---|
| <i>P 1</i> | Overnight turn-off                              | <i>5 0</i> *                           | Deactivated   |
|            |   | <i>5 1</i>                             | Activated<br>The time of day display is turned off from 11 pm to 4 am.  |
| <i>P 2</i> | Warming function                                | <i>5 1</i> *                           | Activated   |
|            |   | <i>5 0</i>                             | Deactivated   |
| <i>P 3</i> | "door" warning                                  | <i>5 1</i> *                           | The "door" warning appears if the door has not been opened for 20 minutes before "Start" is pressed.  |
|            |   | <i>5 0</i>                             | The "door" warning does not appear.   |
| <i>P 4</i> | Signal tone                                     | <i>5 1</i> *                           | Activated<br>A signal sounds briefly as a reminder every 5 - 20 minutes after the end of a program.   |
|            |   | <i>5 0</i>                             | Deactivated   |
| <i>P 5</i> | Demo mode<br>(for dealer and showroom use only) | <i>5 0</i> *                           | Deactivated<br>_____ appears briefly in the display.  |
|            |   | <i>5 1</i>                             | Activated<br>When a button or selector is operated, <i>RES_</i> appears briefly in the display. The appliance can be operated but the microwave will not turn on. |
| <i>P 6</i> | Units of weight                                 | <i>5 1</i> *                           | Weight for automatic programs appears in lb.  |
|            |   | <i>5 0</i>                             | Weight for automatic programs appears in g.   |
| <i>P 0</i> | Factory default                                 | <i>5 1</i> *                           | Factory default setting have been restored, or have not been changed.   |
|            |   | <i>5 0</i>                             | Factory default settings have been changed.   |

For a more detailed description of each setting see the relevant sections of this manual.

# Cleaning and Care

Disconnect the microwave from the power supply before cleaning.

## Microwave interior and inside of the door

Let the microwave cool before cleaning the interior, the inside door and the gasket. Danger of burns!

Clean the microwave after every use, accumulated soiling makes cleaning difficult and could damage the appliance.

Never use abrasive cleaners, scouring pads or steel wool on any part of the microwave. They will damage the surfaces.

Do not use the microwave if the door or gasket is damaged. Contact Miele Technical Service.

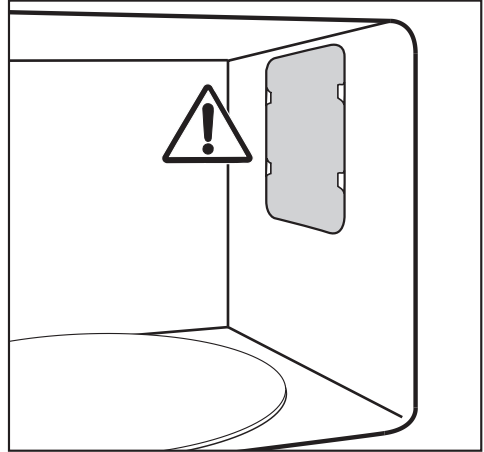

Do not remove the microwave outlet cover inside the microwave, or the protective film covering the inside of the door.

Do not allow water or debris to penetrate the appliance vents.

Avoid using too much water, this could penetrate the openings.

## Cleaning tips

### Hard-to-clean spills

Place a heat-resistant cup of water in the microwave and bring it to a boil. The steam will condensate on the interior walls making it easier to clean.

### Neutralizing odors

Place a heat-resistant cup of water and lemon juice in the microwave and simmer for a few minutes.



## Cleaning the interior

- When cleaning surfaces of the door and oven that come together when the door is closed, use only mild, non-abrasive soaps, or detergents applied with a sponge or soft cloth.

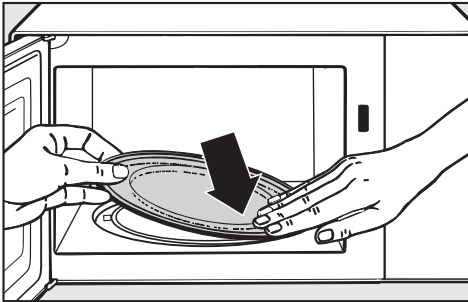

- Remove the turntable and wash in the dishwasher or by hand.

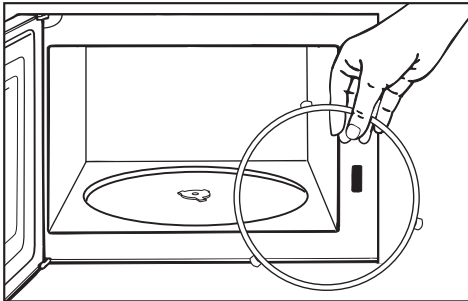

- Remove any debris from the roller ring and the space under the roller ring to ensure the turntable will turn smoothly.
- Clean the area between the turntable and motor.

Do not turn the motor manually, this could cause damage.

## Appliance front

Remove any soiling immediately, otherwise it may become hard to remove and could cause the surface to discolor.

- All external surfaces and controls can be cleaned with warm water and liquid dish soap applied with a sponge.
- Dry with a soft cloth.

## Glass surfaces

Glass surfaces are not scratch proof.

Never use abrasive cleaners, scouring pads, steel wool or oven cleaners on glass surfaces. They will cause damage.

Do not use a shielded scraper blade to clean the door glass surface.

## Accessories

### Boiling wand

The boiling wand can be washed in the dishwasher or by hand.

### Cover

Wash and dry the cover after each use either in a dishwasher or by hand with warm water and liquid dish soap. Discoloration caused by natural dyes, e.g. from tomatoes, carrots, etc. may occur. This discoloration is irreversible but does not affect the performance of the cover.

## Frequently asked questions

---

Installation work and repairs should only be performed by a qualified technician in accordance with all applicable codes and standards. Repairs and other work by unqualified persons could be dangerous and may void the warranty.

The following faults can be corrected without contacting the Miele Service Department:

### What if a program will not start?

| Possible fault                             | Solution                                |
|--|---|
| The door is not closed properly.           | Close the door firmly.                  |
| The "System lock" has been activated.      | See "System lock" for more information. |
| The appliance is not correctly plugged in. | Check the plug.                         |
| The circuit breaker has tripped.           | Check the breaker.                      |

### Why is a noise heard after a program has ended?

This is not a fault. The cooling fan will continue to run for a short time after the microwave has been switched off to dissipate any moisture from the interior. This will prevent it from settling on the control panel or surrounding furniture. The fan will turn off automatically.

### What if the display does not light up?

| Possible fault                                 | Solution                              |
|--|---------------------------------------|
| The time of day display has been turned off.   | Press and hold "⌚" for a few seconds. |
| The "Overnight turn-off" setting is activated. | See "Settings".                       |

## Frequently asked questions

| <b>What if the turntable does not rotate smoothly?</b>  |   |
|---|---|
| <b>Possible fault</b>   | <b>Solution</b>   |
| The area under the roller ring is soiled, or there is debris between the turntable and the motor.     | See "Cleaning and Care".  |
| <b>Why is the food not adequately defrosted, heated or cooked at the end of the selected process?</b> |   |
| <b>Possible fault</b>   | <b>Solution</b>   |
| The program was interrupted.  | After interrupting a program the microwave must be re-started.  |
| The power and/or time settings are incorrect.   | Check if the selected power has the appropriate time setting when cooking with the microwave. The lower the power, the longer the cooking time. |
| <b>Why does the microwave operate but the light is off?</b>   |   |
| The lighting is defective. Contact Miele Technical Service to replace the lighting.                   |   |
| <b>Why are there strange noises when the microwave is being used?</b>                                 |   |
| <b>Possible fault</b>   | <b>Solution</b>   |
| Sparks are created by the use of dishware with a metallic finish.                                     | See "Selecting cookware".   |
| The food is covered with aluminum foil.   | Remove the aluminum foil.   |
| <b>Why is the time of day shown in the display not correct?</b>                                       |   |
| A power failure has occurred. The time of day need to be reset. See "Setting the time of day".        |   |

## Frequently asked questions

### Why does the food cool so fast when heated or cooked with Microwave?

In the microwave, food begins to cook from the outside first, the inside of the food relies on the transfer of heat. If food is cooked at a high power level it is possible that the heat may not have reached the center of the food. At the temperature equalization time the food will become hot in the inside and warm on the outside. When heating a meal, select a lower power level and a longer cooking time.

### Why did the microwave turn itself off during a program?

| Possible fault                             | Solution   |
|--|--|
| There may be insufficient air circulation. | <ul style="list-style-type: none"><li>■ Check if the air inlet or outlet is blocked. Remove any objects.</li></ul> <p>The appliance turns itself off automatically to prevent overheating. The program can be continued once the microwave is allowed to cool.</p> <p>If the microwave turns itself off repeatedly, contact Miele Technical Service.</p> |

Contact Technical Service for all other fault messages or if the fault could not be fixed. Do not open the outer casing of the appliance. The appliance must only be repaired by a qualified service technician.

In the event of a fault which you cannot easily fix yourself, please contact the Miele Technical Service Department at the address on the back of this booklet.

When contacting Technical Service please quote the serial number and model of your microwave. This information is visible on the silver data plate.

### **MieleCare**

(USA only)

*MieleCare*, our Extended Service Contract program, gives you the assurance of knowing that your appliance investment is covered by 5 years of worry free ownership. *MieleCare* is the only Extended Service Contract in the industry that guarantees repairs by a Miele Authorized Service Provider using genuine Miele parts. Only genuine Miele parts installed by factory trained professionals can guarantee the safety, reliability, and longevity of your Miele appliance.

Please note that unless expressly approved in writing by Miele's Service department, Extended Service Contracts offered by other providers for Miele products will not be recognized by Miele. Our goal here is to prevent unauthorized (and untrained) service personnel from working on your Miele products, possibly doing further damage to them, you and/or your home.

To learn more about *MieleCare* Extended Service Contracts, please contact your appliance dealer or visit us online at:

**<http://miele.com/mielecare>**



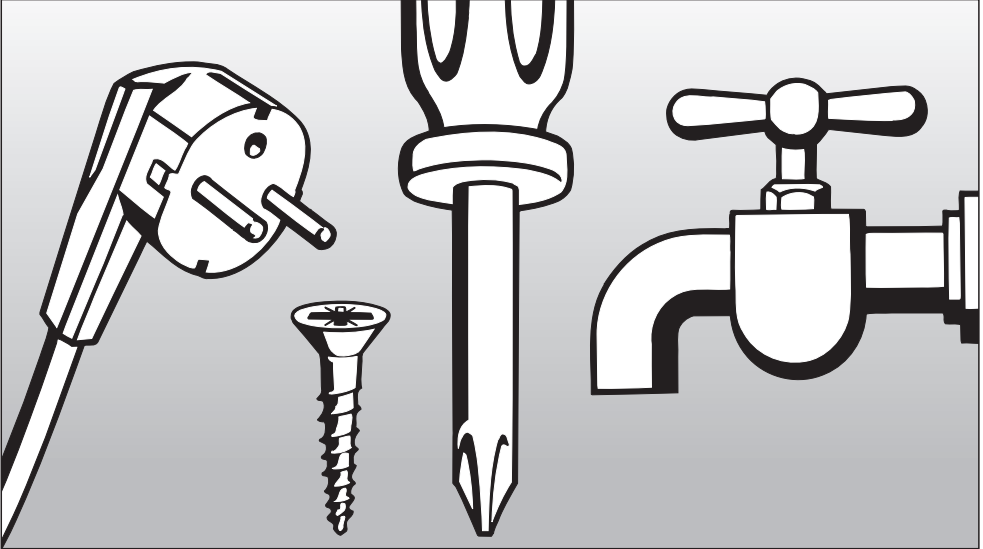

## Installation Instructions

# Caring for the environment

---

## **Disposal of the packing materials**

The cardboard box and packing materials protect the appliance during shipping. They have been designed to be biodegradable and recyclable.

Ensure that any plastic wrappings, bags, etc. are disposed of safely and kept out of the reach of children.  
Danger of suffocation!

## **Disposal of an old appliance**

Old appliances may contain materials that can be recycled. Please contact your local recycling authority about the possibility of recycling these materials.

Ensure the appliance presents no danger to children while being stored for disposal. Before discarding an old appliance, unplug it from the outlet and cut off its power cord. Remove any doors to prevent trapping hazards.



 **CAUTION:** Before servicing, disconnect the power supply by either removing the fuse, shutting off the power main or manually "tripping" the circuit breaker.

Installation work and repairs should only be performed by a qualified technician in accordance with all applicable codes and standards. Repairs and service by unqualified persons could be dangerous.

Before connecting the appliance to the power supply, make sure that the voltage and frequency listed on the data plate correspond with the household electrical supply. This data must correspond in order to prevent machine damage. Consult an electrician if in doubt.

Only operate the appliance after it has been installed into cabinetry.

The appliance must be plugged into an appropriate outlet that is installed and grounded in accordance with all local codes and ordinances.

## Power supply

The microwave comes equipped with a power cord with a molded plug ready for connection to a:

120V, 60 Hz power supply.

## **WARNING: THIS APPLIANCE MUST BE GROUNDED**

### **GROUNDING INSTRUCTIONS**

This appliance must be grounded. In the event of an electrical short circuit, grounding reduces the risk of electric shock by providing an escape wire for the electric current. This appliance is equipped with a cord having a grounding wire with a grounded plug. The plug must be plugged into an outlet that is properly installed and grounded.

**WARNING** - Improper use of the grounding can result in a risk of electric shock.

Consult a qualified electrician or serviceman if the grounding instructions are not completely understood, or if doubt exists as to whether the appliance is properly grounded, do not use an extension cord. If the power supply cord is too short, have a qualified electrician or serviceman install an outlet near the appliance.

## **Installer:**

**Please leave these instructions with the consumer.**

# Installation

When building in the appliance, ensure that the vents located at the front of the appliance are not blocked, and that there is adequate ventilation to the rear of the unit (see illustrations). Do not cover or block any openings on the appliance.

This microwave is suitable for installation into a tall cabinet.

A minimum installation height of 33 7/16" (850 mm) must be maintained.

During transport be sure to lift the appliance by the housing, not by the frame. The framework is not sturdy enough to support the weight of the appliance while being carried.

## Building-in dimensions

### Tall cabinet

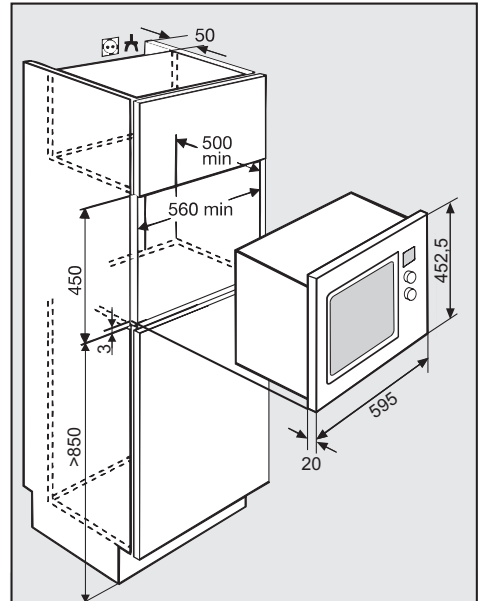
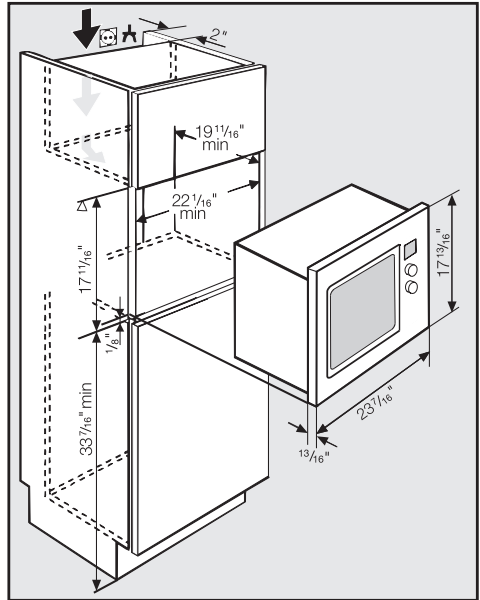

## Installation accessories (supplied)

|   |   |    |
|---|---|----|
| <br>4 x 16mm | A | 3x |
|---|---|----|

Only operate the appliance after it has been installed into cabinetry.

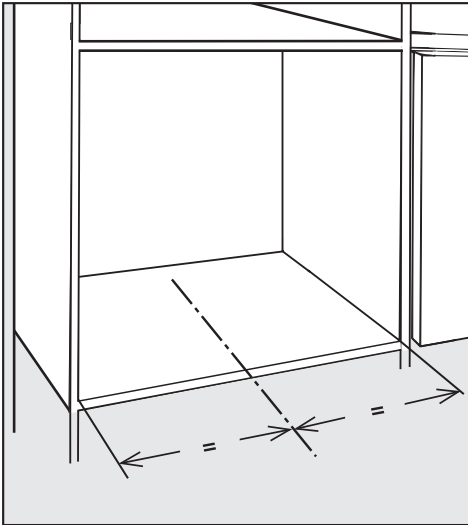

- Mark the center line of the cabinet.

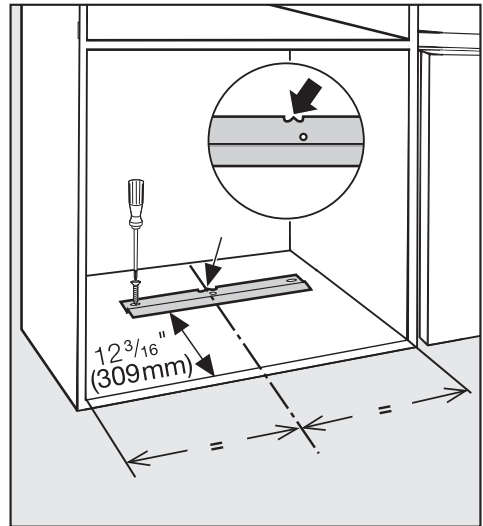

- Position the fitting bracket on the center line. Use the mark on the bracket as a guide.

# Installation

- Fit a screw (A) in to the center of the first long hole.
- Check the alignment of the unit, then fit another screw (A) into the other long hole.
- Tighten both screws.
- Place the appliance in the niche. Using both hands on the back of the microwave interior move it into place. The microwave will engage into position once it is correctly installed.
- Check the alignment.
- If it is not aligned correctly, pull the appliance out of the niche and realign it by slightly adjusting the bracket on the long holes.
- Once correctly aligned, to prevent the unit from moving insert a third screw (A) into the middle of the bracket.

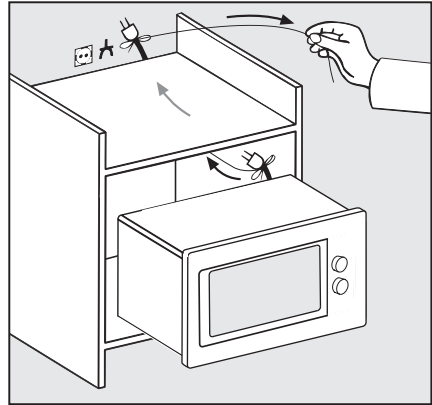

- Slide the unit into the niche, pulling the plug and cable through the back.
- Connect the electrical supply.
- Push the appliance all the way in to the niche as described above.







**Please have the model and serial number  
of your appliance available before  
contacting Technical Service.**

---



**U.S.A.  
Miele, Inc.**

**National Headquarters**

9 Independence Way  
Princeton, NJ 08540  
Phone: 800-843-7231  
609-419-9898  
Fax: 609-419-4298  
[www.miele.com](http://www.miele.com)

**Technical Service & Support  
Nationwide**

Phone: 800-999-1360  
Fax: 888-586-8056  
[TechnicalService@mieleusa.com](mailto:TechnicalService@mieleusa.com)

**Canada  
Miele Limited**

**Headquarters and Showroom**

161 Four Valley Drive  
Vaughan, ON L4K 4V8  
Phone: 800-643-5381  
905-660-9936  
Fax: 905-532-2290  
[www.miele.ca](http://www.miele.ca)  
[professional@miele.ca](mailto:professional@miele.ca)  
(commercial enquiries)

**MieleCare National Service**

Phone: 800-565-6435  
905-532-2272  
Fax: 905-532-2292  
[customercare@miele.ca](mailto:customercare@miele.ca)  
(general and technical enquiries)