

Operating Instructions Oven (Range)



To prevent accidents and damage to the range, you **must** read all instructions supplied before installing or using the appliance.

IMPORTANT SAFETY INSTRUCTIONS

WARNING

Children and adults can tip over the range if has not been secured. This may lead to fatal injuries.

- ▶ This range must be secured and connected using the anti-tip device according to the installation instructions.
- ▶ If you have moved the range, slide the locking latch onto the anti-tip device until you feel it lock into place.
- ▶ Do not use the range if the anti-tip device has not been properly installed and engaged.
- ▶ Failure to observe the information contained in the installation instructions can lead to serious or fatal injuries for children and adults.

	 WARNING
	<p>All ranges can tip</p> <p>Injury to persons could result</p> <p>Install anti-tip devices packed with range</p> <p>See installation instructions</p>



IMPORTANT SAFETY INSTRUCTIONS

⚠ WARNING: If the information in this manual is not followed exactly, a fire or explosion may result causing property damage, personal injury, or death.

- Do not use or store gasoline or other combustible liquids or vapors in the vicinity of this or any other appliance.
- WHAT TO DO IF YOU SMELL GAS
 - Do not try to light any appliance.
 - Do not touch any electric switches.
 - Do not use any phones inside your building.
 - Immediately call your gas supplier from a neighbor's phone. Follow the gas supplier's instructions.
 - If you are unable to reach your gas provider, call the fire department.
- Installation and service must be performed by a qualified installer, qualified service agency or your gas provider.
(In Massachusetts, installation must be performed by a licensed installer / gas fitter.)
- Note to the installer:
Please give these installation instructions to the consumer for the local electrical/gas inspector.



Contents

IMPORTANT SAFETY INSTRUCTIONS	2
IMPORTANT SAFETY INSTRUCTIONS	7
Guide to the range	19
Oven	19
Control panel	20
Burner knob	20
Temperature selector	21
Operating mode selector	21
Clock / Timer	22
Display	22
Symbols in the display	22
Sensor buttons	22
Temperature indicator 	22
Features	23
Model numbers	23
Data plate	23
Items included with this range	23
Standard and optional accessories	23
Shelf runners	24
Universal tray and Wire oven rack	24
FlexiClips with wire rack HFCBBR 30-2	25
Oven safety features	28
System lock  for the oven	28
Cooling fan	28
Vented oven door	28
Safety Door Lock for Self Clean	28
PerfectClean surfaces	29
Self Clean ready accessories	29
Before first use	30
Before using for the first time	30
Setting the time of day for the first time	30
Heating the oven	31
Operating the oven	32
Energy saving tips	32
Using the oven	32
Cooling fan	32
Preheating the oven	33
Guide to the modes	34

Clock / Timer	35
Turning a cooking program On / Off automatically	35
Setting the cooking time	35
Setting a cooking time and finish time	36
At the end of the cooking time	37
Changing the cooking time	37
Deleting a cooking time.....	38
Deleting a finish time	38
Changing the time of day	39
Changing factory default settings	40
System lock 	43
Timer	45
Setting the timer.....	45
Bake	47
Roast	49
Slow Roasting	51
Broil	53
Defrost	55
Canning	56
Dehydrate	57
Frozen food	58
Cleaning and care	59
Unsuitable cleaning agents	59
Normal soiling.....	60
Stubborn soiling	61
Self Cleaning the oven interior	62
Preparing for the Self Clean program.....	62
Starting the Self Clean program	63
At the end of the Self Clean program.....	64
The Self Clean program is canceled	65
Door removal.....	66
Reinstalling the door	67
Removing the shelf runners.....	68
Frequently Asked Questions	69

Contents

Technical Service	73
Contact in case of fault	73
Warranty	73

IMPORTANT SAFETY INSTRUCTIONS

When using the appliance, follow basic safety precautions, including the following:

Read all instructions before installation and use of the range to prevent accidents and machine damage.

This range complies with current safety requirements. However, improper use of the appliance can result in personal injury or damage to property.

Please read the installation instructions carefully before installing and connecting the appliance.

Read the operating instructions before using the range for the first time. To prevent accidents and damage to the appliance, always observe both the installation instructions and operating instructions. Both documents contain important information about installation, safety, use and maintenance.

Miele cannot be held liable for damage occurring as a result of non-compliance with the instructions.

Keep these installation instructions and operating instructions in a safe place and pass them on to any future owner.

IMPORTANT SAFETY INSTRUCTIONS

Appropriate use

- ▶ This range is intended for domestic use and use in other similar environments.
- ▶ This appliance is not intended for outdoor use.
- ▶ Only use this oven for residential cooking, and the purposes described in this manual.
Other uses are not permitted and can be dangerous.
- ▶ Risk of Fire! Do not use this oven to store or dry combustible materials.
- ▶ Persons who lack physical, sensory or mental abilities, or experience with the appliance should not use it without supervision or instruction by a responsible person.

IMPORTANT SAFETY INSTRUCTIONS

Safety with children

- ▶ As with any appliance, close supervision is necessary when the oven is used by children.
- ▶ Do not leave children unattended: Children should not be alone or unsupervised in the area where the appliance is installed. Do not allow them to sit or stand on the appliance.
- ▶ Children must be kept away from the range unless constantly supervised.
- ▶ Children ages eight and up may only use the range without supervision if they have been shown how to use it in a safe manner, and if they are able to recognize and understand the potential risks of improper use.
- ▶ Children must not be allowed to clean or maintain the range without supervision.
- ▶ Please supervise any children in the vicinity of the range and do not let them play with the appliance.
- ▶ Danger of burns. The oven gets hot at the oven door glass, the vapor vent, the handle and the operating controls. Do not allow children to touch or play in, on or near the oven.
- ▶ Danger of burns.
Children's skin is more sensitive to high temperatures than that of adults. The oven becomes hotter during self-cleaning than it does in normal use. Do not let children touch the oven while the Self Clean program is running.
- ▶ Burn hazard from improper use! Do not allow children to operate the oven.
- ▶ Danger of suffocation! Ensure that any plastic wrappings, bags, etc. are disposed of safely and kept out of the reach of children.

IMPORTANT SAFETY INSTRUCTIONS

▶ **Burn hazard!**

Keep the spaces above and behind the range clear of any items that could draw the attention of children. Otherwise, they can be tempted into climbing onto the appliance.

▶ **Danger of injury.** Never allow children to hang or lean on any part of the appliance.

IMPORTANT SAFETY INSTRUCTIONS

Technical safety

- ▶ Unauthorized installation, maintenance, and repairs can cause considerable danger for the user. Installation, maintenance, and repairs must only be carried out by a Miele authorized technician.
- ▶ Do not carry or lift the range by the oven door handle or the control panel!
- ▶ Maintenance by the user: Never repair or replace any part of the appliance unless the instructions specifically recommend doing so. Service work should only be performed by a qualified technician.
- ▶ A damaged range can be dangerous. Always check for visible signs of damage. Never use a damaged appliance.
- ▶ Reliable and safe operation of the range can only be guaranteed if it is connected to the public power supply.
- ▶ The electrical safety of the range can only be guaranteed when it is properly grounded. Compliance with this essential safety requirement is absolutely mandatory. If in any doubt, please have the building's wiring system inspected by a qualified electrician.
- ▶ Proper installation: Make sure that your appliance has been installed correctly and that it has been grounded by a qualified technician.
- ▶ The oven is not to be operated until it has been properly installed within cabinetry.
- ▶ To avoid damaging the range, make sure that the connection data (voltage and frequency) on the data plate correspond to the building's power supply before connecting the appliance. When in doubt, consult a qualified electrician.

IMPORTANT SAFETY INSTRUCTIONS

- ▶ During installation, maintenance and repair work, e.g. if the oven lighting is broken, the range must be completely disconnected from the household electricity supply (see“Frequently asked questions”). The gas inlet valve must be closed. It is only completely isolated from the supply when:
- The circuit breakers have been switched off, or
 - the fuses of the electrical installation have been completely removed, or
 - the plug (if present) is removed from the socket. To do this, pull the plug not the cord.
 - Shut off the gas supply and disconnect the range from the gas supply. Installation and maintenance of the gas connection must be performed by qualified installers, service agencies or gas providers.
- ▶ Do not use a power strip or extension cord to connect the range to electricity. These are a fire hazard and do not guarantee the required level of appliance safety.
- ▶ Any contact with live connections or tampering with the electrical or mechanical components of the range will endanger your safety and may lead to appliance malfunctions.
Do not open the appliance housing under any circumstances.
- ▶ This appliance must not be installed and operated in mobile installations (e.g. on a ship).
- ▶ Any repairs not performed by a Miele authorized service technician will void the warranty.
- ▶ Defective components should be replaced by Miele original parts only. Only with these parts can safety of the appliance be assured as intended by the manufacturer.

IMPORTANT SAFETY INSTRUCTIONS

- ▶ If the range is installed behind a cabinet door, do not close the door while the appliance is in operation. Heat and moisture can build up behind the closed door and cause damage to the range and to the surrounding cabinets and flooring. Do not close the door until the appliance has completely cooled down.
- ▶ Reaching over a hot cooktop to access the cabinets can result in burns. You can reduce the risk of burns by installing a range hood that extends at least 4 3/4" (12 cm) past the bottom of the cabinets.

IMPORTANT SAFETY INSTRUCTIONS

Correct use

 The oven becomes very hot while in use. Use caution to ensure that you are not burned on the heating elements or interior surfaces of the oven. Use pot holders when placing food in the oven, adjusting the racks, etc. in a hot oven.

- ▶ Caution: Heating elements may be hot even though they are not glowing. Interior surfaces of an oven become hot enough to cause burns. External parts of the oven such as the door glass, vents, and the control panel can become hot. During and after use, do not touch, or let clothing or other flammable materials come into contact with heating elements or interior surfaces of the oven until they have had sufficient time to cool.
- ▶ Do not let food sit in the oven for an extended period of time before or after cooking. Doing so can result in food poisoning or sickness.
- ▶ Use only dry, heat-resistant potholders. Moist or damp potholders used on hot surfaces may result in steam burns. Do not let potholders come in contact with oil or grease. Do not substitute dish towels or other bulky items for potholders. Do not let potholders touch hot heating elements.
- ▶ Loose fitting or hanging garments present a fire hazard. Wear proper apparel while operating the appliance.
- ▶ Do not heat up food in closed containers, as pressure will build up in the container, causing them to explode. Do not use the range to boil or heat up cans.
- ▶ Never pour cold water onto hot surfaces in a hot oven. The steam created could cause serious burns or scalding and the sudden change in temperature can damage the enamel in the oven.
- ▶ To prevent burns, always place oven racks at their desired height while the oven is cool. If the rack must be moved while the oven is hot, do not let pot holders touch hot heating elements.

IMPORTANT SAFETY INSTRUCTIONS

- ▶ Open the door carefully to allow hot air or steam to escape before placing or removing food.
 - ▶ To prevent burns, allow the heating elements to cool before cleaning by hand.
 - ▶ Do not leave the oven door open unnecessarily as someone may trip over it or be injured by it.
 - ▶ Never leave the appliance unattended when cooking with oil or fat. They can ignite if overheated. Do not use water on grease fires. Turn off the oven immediately and suffocate the flames by keeping the oven door closed.
 - ▶ Smother the fire or flames, or use a dry chemical extinguishing agent or foam fire extinguisher.
 - ▶ Never store flammable liquids and materials in, above or under an oven, or near cooking surfaces.
 - ▶ The high temperatures radiated could cause objects near the oven to catch fire.
- Do not use the oven to heat the room.

WARNING

NEVER use this appliance as a space heater to heat or warm the room. Doing so may result in carbon monoxide poisoning and overheating of the oven.

WARNING

NEVER use this appliance as storage space. Doing so may result in carbon monoxide poisoning and overheating of the oven.

IMPORTANT SAFETY INSTRUCTIONS

WARNING

NEVER cover any slots, holes or passages in the oven bottom or cover an entire rack with materials such as aluminum foil. Doing so blocks air flow through the oven and may cause carbon monoxide poisoning. Aluminum foil linings may also trap heat, causing a fire hazard.

- ▶ Broiling food for an excessively long time can cause it to dry out and may result in the food catching fire.
Do not exceed recommended broiling times.
- ▶ Some foods dry out very quickly and can be ignited by high broiling temperatures.
Do not use broiling functions for crisping rolls or bread or to dry flowers or herbs. Instead use the Conv Bake (Convection Bake) or Surround functions.
- ▶ Use caution when using alcohol in your recipes. Alcohol evaporates at high temperatures but may, in rare circumstances, combust on the hot heating elements.
- ▶ Plastic or aluminum foil cookware melts at high temperatures and can damage the range or start to burn. Do not use any plastic or aluminum foil cookware.
Exception: You can use oven-safe plastic cookware in the oven. Heed the cookware manufacturer's instructions.
- ▶ When residual heat is used to keep food warm, the high level of humidity and condensation can cause damage in the oven. The control panel, countertop or cabinetry may also be damaged.
Do not switch the oven off completely while food is inside it, but select the lowest possible temperature for the oven mode you are using. This will ensure the fan will automatically continue to run.
- ▶ It is recommended to cover all cooked food that is left in the oven to be kept warm. This will prevent moisture from condensing on the interior of the oven.

IMPORTANT SAFETY INSTRUCTIONS

- ▶ To avoid damage, do not place aluminum foil, pots, pans or baking sheets directly on the oven floor. This can cause a build up of heat that will damage the oven floor.
- ▶ Do not slide pots or pans on the oven floor. This could scratch and damage the surface.
- ▶ The door can support a maximum weight of 33 lbs (15 kg). Do not sit on or lean against an open door, and do not place heavy objects on it. Also make sure that nothing can get trapped between the door and the oven cavity. The oven could get damaged.
- ▶ This oven must only be used for cooking food. Fumes, vapors or heat given off by glues, plastics or flammable liquids and materials could be hazardous. Do not use it as a dryer, kiln, dehumidifier, etc.
- ▶ Do not obstruct the flow of combustion and ventilation air.
- ▶ Do not let metal objects (aluminum foil, pans) come in contact with the heating element.
- ▶ Make certain that the power cords of small appliances do not come in contact with or get caught in the oven door.
- ▶ When baking frozen pizzas or pies, place them on the wire rack lined with parchment paper. Do not use the baking tray or the roasting pan for frozen foods with a large surface area. The tray or pan could become warped and difficult to remove from the oven when hot. Frozen foods like french fries, chicken nuggets, etc. can be baked on the baking tray.

Cleaning and maintenance

- ▶ The steam from a steam cleaning appliance could reach live electrical components and cause a short circuit. Do not use a steam cleaner to clean the range.
- ▶ Only clean parts listed in these Operating and Installation Instructions.

IMPORTANT SAFETY INSTRUCTIONS

- ▶ Scratches on the door glass can cause the glass to break. Do not use abrasive cleaners, hard sponges, brushes or sharp metal tools to clean the door glass.
- ▶ The shelf runners can be removed for cleaning purposes (see “Cleaning and care”). Ensure they are correctly fitted after cleaning and never operate the oven without the shelf runners inserted.
- ▶ There is a seal around the oven interior which seals the inside of the door. Take care not to rub, damage or move the gasket. Do not clean the door gasket - the door gasket is essential for a good seal.
- ▶ Do not use a protective coating to line the oven and do not use commercial oven cleaner unless certified for use in a self-cleaning oven.
- ▶ Debris should be removed before running the Self Clean program. If not removed this debris can smoke causing the self-cleaning program to turn itself off.

Accessories

- ▶ Use only genuine original Miele parts. If parts or accessories from other manufacturers are used, the warranty will become void.
- ▶ The high temperatures used during self-cleaning will damage accessories that are not designed for cleaning in the Self Clean program. Please remove these accessories from the oven before starting the Self Clean program. This also applies to accessories purchased separately (see “Cleaning and care”).

SAVE THESE INSTRUCTIONS AND REVIEW THEM PERIODICALLY

Oven

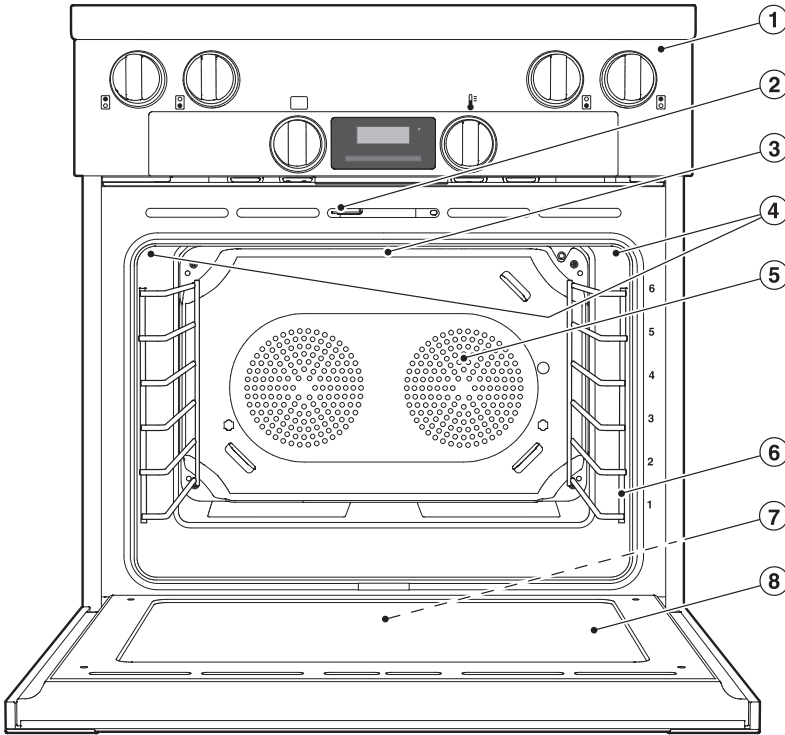

- ① Oven and cooktop controls
- ② Door lock with contact switch for Self Clean *
- ③ Browning/Broiling element
- ④ Oven interior lighting
- ⑤ TwinPower convection fan with heating element
- ⑥ Side runners with 6 shelf levels
- ⑦ Data plate
The data plate is located behind the toe kick cover.
- ⑧ Door

* This switch ensures that the heating elements and the convection fans turn off when the door is opened during use.

Control panel

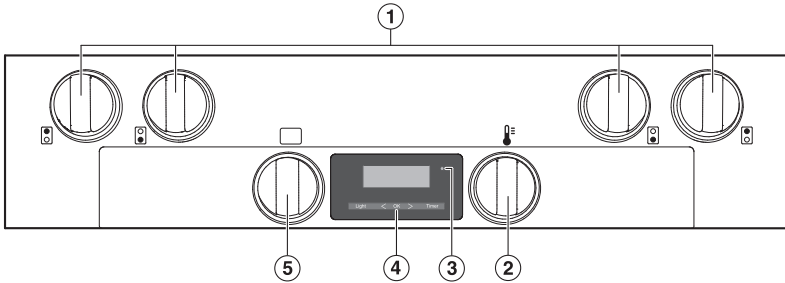

- ① Burner knobs
- ② Temperature selector
- ③ Optical interface
(for Service technicians only)
- ④ Timer with display and sensor buttons for light, <, OK, >, and the time.
- ⑤ Operating mode selector

Burner knob

With the burner knob, you can ignite the burner and regulate the flame. The burners can be variably adjusted between the lowest and highest settings.

Temperature selector

The temperature selector is used to select the temperature for a cooking mode.

It can be turned clockwise until a resistance is felt and then turned back again.

The temperature settings are marked on the temperature selector.

Operating mode selector

To select an operating mode.

It can be turned clockwise or counter-clockwise.

The operating modes are printed on the mode selector.

Operating modes

- Rapid (Rapid PreHeat)
- Bake
- Broil
- Surround
- Clean (Self Clean)
- Conv Broil (Convection Broil)
- Conv Bake (Convection Bake)

Control panel

Clock / Timer

The clock/timer is operated via the Display with the sensor buttons.

Display

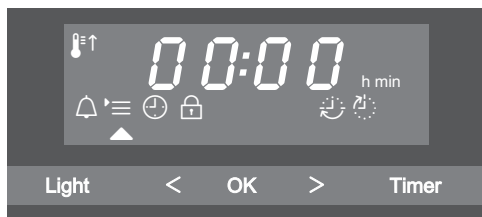

The display shows the time of day or your settings.

See “Clock / Timer” for more information.

Symbols in the display

Depending on the position of the mode selector \bigcirc and/or which button is pressed, the following symbols will appear:

Symbol / Mode	\bigcirc
Timer	Any
Temperature indicator	Operating mode
Cooking time	
Finish time	
Settings <i>P</i>	Off
Time of day	
System lock	

A mode can only be set or changed if the mode selector is in the correct position.

Sensor buttons

The range has sensor buttons for light, <, OK, >, and timer, which react to the touch of a finger. Each touch is confirmed with an audible tone.

The tone can be turned on or off by selecting the status *P* 4 in the settings 5 / (see “Settings”).

Temperature indicator

The temperature indicator light lights up when the oven is heating.

When the set temperature is reached,

- the oven heating turns off,
- and the temperature indicator light goes out.

The temperature regulator ensures that the oven heating and temperature indicator light turn back on again when the oven temperature falls below the level set.

Model numbers

A list of the ovens described in these operating instructions can be found on the back page.

Data plate

The data plate is behind the toe-kick. The toe-kick cover is attached to the base of the range by magnets so it can be removed and put back again easily.

There you can find the model number, the serial number and the connection data (voltage/frequency/maximum rated load) for your range.

Have this information available when contacting Miele Technical Service.

Items included with this range

The following items are included with this appliance:

- Installation instructions for the range
- The operating instructions for the range:
 - Gas Cooktop
 - Convection Oven
- An anti-tip device, including screws for fastening the range
- Various accessories

Standard and optional accessories

Accessories vary depending on model.

All ovens are supplied with shelf runners, a universal tray and a wire rack.

Depending on the model, your range may also be supplied with other accessories listed here.

All accessories and cleaning and care products listed in these instructions are designed to be used with the Miele range.

These can be ordered via the Miele website, from Miele (see end of this booklet for contact details) or from your Miele dealer.

When ordering, please have ready the model number of your range and of the desired accessories.

Features

Shelf runners

The shelf runners are located on the right and left-hand sides of the oven with the levels for inserting accessories.

The shelf level numbers are indicated on the front of the oven frame.

Each level consists of a strut on which you can place the wire oven rack, for example.

The runners can be removed. See “Cleaning and Care”.

Universal tray and Wire oven rack

Universal tray HUBB 30-1

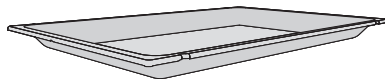

Wire oven rack HBBR 30-2

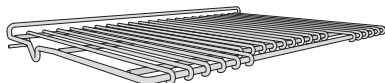

Non-tip safety notches are located on the shorter sides of these accessories. These prevent the trays being pulled completely out of the side runners when you only wish to pull them out partially.

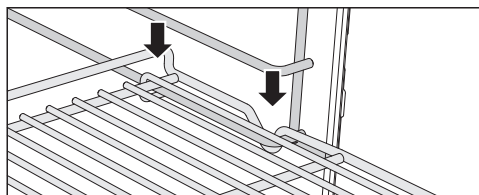

Always place the wire oven rack on the runner with the notch facing down.

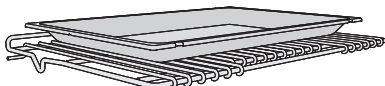

When using the universal tray, place it directly on the wire oven rack.

FlexiClips with wire rack HFCBBR 30-2

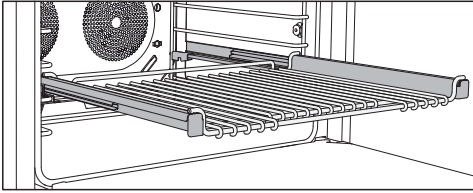

The FlexiClips with wire rack can be mounted on any shelf level and pulled completely out of the oven. This allows you to see the food easily.

The FlexiClips with wire rack is pushed in and then locked onto a level.

The rack can hold a maximum of 33 lbs (15 kg).

Installing and removing the FlexiClips with wire rack

 **Danger of burns!** Make sure the heating elements are turned off and that the oven cavity is cool.

Do not pull the FlexiClips apart during installation or removal.

- Hold the FlexiClips with wire rack with both hands and position it in front of the desired level.

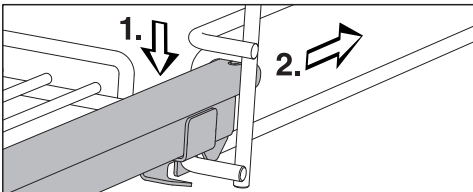

- Insert the FlexiClips with wire rack onto the level (1.) and slide it along the struts of the level (2.) until it clicks into place.

If the FlexiClips with wire rack jams when sliding it onto the level, pull it out using some force and reinsert.

To removing the FlexiClips with wire rack:

- Push the FlexiClips with wire rack in all the way.

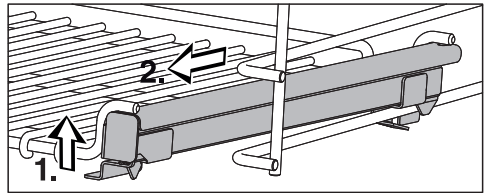

- Using both hands lift the front of the FlexiClips with wire rack on both sides (1.) and pull it out of the level (2.).

Using the universal tray

- When using the universal tray, place it directly on the FlexiClips with wire rack.

Features

Temperature selector with °C scale

The range is delivered with a temperature selector with °F scale. You can get the temperature selector with °C scale as an accessory. Specify the model of your range when purchasing.

Replacing the temperature selector

 Do not operate the range without an installed temperature selector.

- Turn the temperature selector to • (Off).
- Pull the temperature selector off the range horizontally.
- Install the new temperature sensor in the same position and push it onto the range.

Perforated Gourmet baking tray HBBL 71

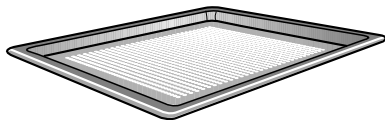

The perforated Gourmet baking tray has been specially developed for the preparation of baked goods made from fresh yeast and quark doughs. The tiny perforations assist in browning the underside of baked goods. The tray can also be used for dehydrating or drying food.

The enameled surface has been treated with PerfectClean.

The **round perforated baking tray HBFP 27-1** can be used for the same things.

The perforated baking tray can be placed on the rack.

Grilling and Roasting insert HGBB 30-1

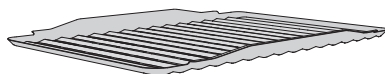

The grilling and roasting insert is placed in the universal tray.

The drippings from the meat or poultry are collected under the insert reducing spattering in the oven. The drippings can then be used for gravy and sauces.

The surface has been treated with PerfectClean enamel for easy cleaning.

Round baking form HBF 27-1



This circular form is suitable for cooking fresh or frozen pizzas, flat cakes, tarts and baked goods.

The surface has been treated with PerfectClean enamel.

Gourmet Baking Stone HBS 60

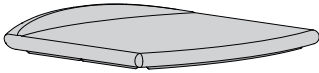

The baking stone is ideal for baking dishes with a crisp bottom such as pizza and bread.

The baking stone is made from a heat retaining stone and is glazed. Place the stone directly on the wire rack.

A wooden peel is supplied with it for placing food on and off the stone.

HUB Gourmet casserole dishes HBD casserole dish lids

Miele Gourmet casserole dishes can be placed directly on the wire oven rack. The surface of the casserole dishes has a non-stick coating.

Gourmet casserole dishes are available in different depths. The width and the height are the same.

Suitable lids are available separately. Please quote the model number when ordering.

Depth:
8 1/2" (22 cm)

HUB 62-22 *



HBD 60-22

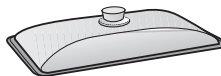

Depth:
13 3/4" (35 cm)

HUB 62-35 *

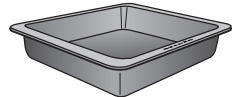

HBD 60-35

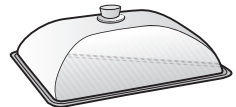

* Suitable for use on induction cooktops

Opener

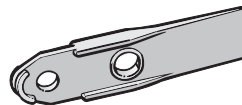

The opener allows you to open the cover of the oven light.

Miele Oven Cleaner

Miele oven cleaner is suitable for removing stubborn soiling. It is not necessary to preheat the oven before use.

Features

Oven safety features

System lock for the oven

The system lock prevents the oven from being used unintentionally (see “System lock ”).

The system lock will remain activated even after a power failure.

Cooling fan

The cooling fan comes on automatically when a cooking program is started. The cooling fan mixes hot air from the oven cavity with cool room air before venting it out into the kitchen through vents located between the appliance door and the control panel.

The cooling fan will continue to run for a while after a program is complete to prevent moisture from building up in the oven, on the control panel or surrounding cabinetry.

When the temperature in the oven has fallen sufficiently, the cooling fan will turn off automatically.

Vented oven door

The oven door is made of glass panes that have a heat-reflective coating on part of their surface.

During operation, air is also circulated through the door to keep the outer panel cool.

The door can be removed and disassembled for cleaning purposes (see “Cleaning and care”).

Safety Door Lock for Self Clean

For safety reasons, the door is locked as soon as the Self Clean program is started. After the self-cleaning program has finished, the door will remain locked until the temperature in the oven has fallen below 535°F (280°C).

PerfectClean surfaces

The revolutionary PerfectClean finish is a smooth, non-stick surface that is exceptionally easy to clean.

Food and grime from baking or roasting are easily removed.

Do not use ceramic knives, as these will scratch the PerfectClean surface.

Follow the instructions in the “Cleaning and Care” section of this manual so the anti-stick and easy cleaning properties are retained.

The following have all been treated with PerfectClean:

- Universal tray
- Grilling and Roasting insert
- Perforated baking tray
- Round baking form

Self Clean ready accessories

The following accessories can be left in the oven during the Self Clean program.

- Shelf runners,
- FlexiClips with wire rack
- Wire oven rack

See “Cleaning and care” for more information.

Before first use

Before using for the first time

 The range may only be operated after it has been installed properly. Read the operating and installation instructions carefully before installing the range..
Read the operating instructions carefully before starting up the range.

The time of day can only be changed when the mode selector is set to Off.

- Set the time of day.

Setting the time of day for the first time

The time of day is shown in 12 hour clock format.

After connection the oven to the electrical supply *12:00* will appear in the display and a ▲ will flash under :



- Use < or > to set the time of day.
- Confirm with OK.

The time of day is now saved.

Change the time of day to a 12-hour format by setting *12h* in the settings menu *P 4* (see “Settings”).

During a power failure, the time of day will be saved for approx. 200 hours. If the power returns within this period of time the current time of day is displayed again. If the power is out for an extended period of time the time of day will need to be reset.

The time is day is turned off by default (see “Settings - *P 1*”).

The display will appear dark when the oven is turned off. The time of day continues to run unseen in the background.

Heating the oven

New ovens may have a slight odor during their first use. Heating up the oven for at least an hour with nothing in it will eliminate the odor.

Ensure that the kitchen is well ventilated while the appliance is being heated up for the first time. Close doors to other rooms to prevent the smell spreading throughout the house.

- Remove any protective wrapping and sticky labels from the oven.
- Take all accessories out of the oven and clean them (see “Cleaning and care”).
- Before heating the oven up, wipe the interior with a damp cloth to remove any dust or bits of packaging that may have accumulated in the oven cavity during storage and unpacking.
- Select the operating mode Conv Bake (Convection Bake)

The oven heating, lighting and cooling fan will turn on.

- Select the maximum temperature 475°F (250°C).
- Heat up the oven for at least one hour.
- Once the heating up process is complete, turn the mode selector to **Off** and the temperature selector to • (Off).

After heating up for the first time

 Danger of burns! Allow the oven to cool before cleaning.

- Select “Light” to turn on the oven light.
- Clean the oven interior with warm water and liquid dish soap, applied with a soft sponge or cloth.
- Dry all surfaces with a soft cloth.
- Turn the oven lighting off.

Leave the oven door open until the oven interior is completely dry.

Operating the oven

Energy saving tips

- Remove any accessories from the oven that you do not require for cooking.
- Only preheat the oven if the recipe or cooking chart advises.
- Try not to open the door when cooking.
- If a temperature range is given, it is best to select the lower temperature and check the food after the shortest cooking time given.
- Use the operating mode Conv Bake (Convection Bake). You can use cooking temperatures 10-30° lower than when using other modes.
- Conv Broil (Convection Broil) can be used for a wide variety of foods. Lower temperatures can be used than with other broil modes that use the maximum temperature setting.

Using residual heat

Tip: When cooking using temperatures above 285°F (140°C) and cooking durations longer than 30 minutes, you can turn the temperature selector to the • (Off) position about 5 minutes before the end of cooking. The heating elements will turn off and the residual heat in the oven will be sufficient to finish cooking the food.

Using the oven

- Place the food in the oven.
- Using the mode selector, select the required oven mode.

The oven lighting and the TwinPower fans will turn on.

- Select the temperature using the temperature selector.

The oven heating will turn on.

After the cooking process:

- Turn the mode selector to **Off** and the temperature selector to • (Off).
- Take the food out of the oven.

Cooling fan

After the cooking process the cooling fan will continue to run for a while after a program is complete to prevent moisture from building up in the oven, on the control panel or surrounding cabinetry.

When the temperature in the oven has fallen sufficiently the cooling fan will turn off automatically.

Preheating the oven

The appliance only needs to be preheated in a few cases.

Most dishes can be placed in a cold oven. They will then use the heat produced during the heating phase.

The oven should be preheated in the following instances:

Conv Bake (Convection Bake)

- dark bread doughs,
- beef sirloins and tenderloins.

Surround

- cakes and pastries with a short baking time (up to 30 minutes),
- delicate mixtures,
- dark bread doughs,
- beef sirloins and tenderloins.

Rapid PreHeat

With Rapid (Rapid PreHeat) the preheating phase can be shortened.

Do not use Rapid (Rapid PreHeat) when baking pizzas or delicate mixtures (e.g. small cakes, pastries). The tops of these items will brown too quickly.

- Select Rapid (Rapid PreHeat).
- Select a temperature.
- Set the desired oven function when the temperature indicator light  goes out for the first time.
- Place the food in the oven.

Guide to the modes

The oven has a range of modes for preparing a variety of foods.

Rapid (Rapid PreHeat)

(Browning / Broiling element + Convection fan with heating element)

This function allows the oven to be heated to the desired temperature quickly. Once the desired temperature has been reached the oven function must be selected.

Bake

(Baking element)

This mode uses traditional baking techniques to perfect pies and biscuits.

Broil

(Browning / Broiling element)

Use this function for broiling or searing small quantities. Ideal for chops, ribs, browning baked dishes and toasting bread.

Surround

(Browning / Broiling element + Baking element)

This premium baking mode uses heat from the upper and lower elements to create perfect results on all baking recipes.

If using an older recipe or cookbook, set the oven temperature 10 ° lower than that recommended. This won't change cooking times.

Conv Broil (Convection Broil)

(Browning / Broiling element + Convection fans)

This allows for a lower temperature to be used then when using broil. Ideal for broiling thicker cuts of meat (e.g. roulades, chicken). This function distributes hot air from the browning / broiling element over the food using the fan.

Conv Bake (Convection Bake)

(Convection fans with heating element)

Use this mode for baking and roasting on several levels at the same time. You can cook at lower temperatures than with the Surround function because the fans distribute the heat evenly throughout the cavity for a consistent baking temperature.

Turning a cooking program On / Off automatically

You can set a cooking program to turn on or off automatically. First the mode and cooking temperature must be selected.

The maximum duration that can be set for a cooking program is 12 hours.

It is recommended to use the automatic On/Off feature when roasting. Do not delay the start of the program for too long when baking. Cake mixtures and doughs will dry out, and the leavening agents will lose their effectiveness.

Setting the cooking time

Example: Baking a cake for 1 hour 5 minutes.

- Place the food in the oven.
- Select the required oven mode and temperature.

The oven heating, lighting and cooling fan will turn on.

- Select OK.
- If necessary, move the symbol ▲ with < or > until it appears under ⌚.
- Confirm with OK.

00:00h will appear in the display along with a ▲ flashing under ⌚.



- Use < or > to set the cooking time (01:05).
- Confirm with OK.

The cooking time is saved and then counts down in minutes, with the last minute counting down in seconds.

The ⌚ symbol indicates that a cooking time has been set.

Clock / Timer

Setting a cooking time and finish time

Example: The time is now 11:15 AM; you want a dish with a cooking time of 90 minutes to be ready by 1:30 PM.

- Place the food in the oven.
- Select the required oven mode and temperature.

The oven heating, lighting and cooling fan will turn on.

Set the cooking time:

- Select OK.
- If necessary, move the symbol ▲ with < or > until it appears under .
- Confirm with OK.

00:00h will appear in the display along with a ▲ flashing under .

- Use < or > to set the cooking time (01:30).
- Confirm with OK.

The cooking time  is saved and then counts down in minutes:



Set the finish time:

- Move the symbol ▲ with < or > until it appears under .

--:-- appears:



- Confirm with OK.

12:45 will appear in the display (current time of day + cooking time = 11:15 + 1:30):



- Use < or > to set the end of the cooking time (13:30).
- Confirm with OK.

The finish time  is now saved:



The oven heating, lighting and cooling fan will turn off.

As soon as the start time (13:30 - 1:30 = 12:00) has been reached, the oven heating, lighting and cooling fan will turn on.

At the end of the cooking time

- 0:00 appears in the display,
 -  flashes,
 - the oven heating and lighting will turn off,
 - the cooling fan will continue to run, and
 - a signal will sound if turned on (see “Settings - P 2”).
- Turn the mode selector to Off.
 - Take the food out of the oven.

If the dish is not cooked to your liking, you can extend the cooking time by entering a new time.

Changing the cooking time

- Select OK.
- If necessary, move the symbol ▲ with < or > until it appears under .

The cooking time remaining appears in the display.

- Confirm with OK.
- Change the cooking time with < or >.
- Confirm with OK.

The changed cooking time is now saved.

Clock / Timer

Deleting a cooking time

- Select OK.
- If necessary, move the symbol ▲ with < or > until it appears under .
- Confirm with OK.

The ▲ symbol will flash under .

- Use < to set the cooking time to *00:00*.
- Confirm with OK.

The cooking time and finish time are deleted.

- Select OK.

The current temperature will appear.
The oven heating remains turned on.

If you would like to complete the cooking program:

- Turn the mode selector to Off.
- Take the food out of the oven.
- Turn the oven off.

If you turn the mode selector to 0, the settings for the cooking time and the finish time will be deleted.

Deleting a finish time

- Select OK.
- If necessary, move the symbol ▲ with < or > until it appears under .
- Confirm with OK.

The ▲ symbol will flash under .

- Use < or > to set the end of the cooking time to - :- -.
- Confirm with OK.

The finish time is now deleted.

Changing the time of day

The time of day can only be changed when the mode selector is set to Off.

- Turn the mode selector to Off.
- Select OK.
- Move the symbol ▲ with < or > until it appears under ⌚.
- Confirm with OK.

The ▲ symbol will flash under ⌚.

- Use < or > to set the time of day.
- Confirm with OK.

The time of day is now saved.

During a power failure, the time of day will be saved for approx. 200 hours. When the power returns within this period of time the current time is displayed again.

After an extended power failure, the time of day will need to be reset.

Clock / Timer

Changing factory default settings

The appliance is supplied with a number of default settings (see the “Settings overview” chart).

A setting can be changed by altering its status.

The settings can only be changed when the mode selector is on Off.

- Select OK.
- If necessary, move the symbol ▲ with < or > until it appears under '≡.

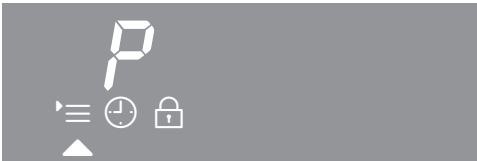

- Confirm with OK.

P 1 appears:



- If you want to change another setting, select the appropriate number with < or >.
- Confirm with OK.



The setting is selected and the current status appears, e.g. *5 0*.

To change the status:

- Set the desired status using < or >.
- Confirm with OK.

The status is saved and the setting appears again.

- If you would like to change additional settings, repeat the process.
- If you have completed changing settings, select '≡.

The settings will remain in memory even in the event of a power failure.

Settings overview

Setting	Status
<i>P 1</i> Time of day display	<p><i>S 0*</i> The time of day display is turned off. The display is dark when the oven is turned off. The time of day continues to run unseen in the background. If you have selected status <i>S 0</i>, the oven must be turned on before it can be used. This also applies for the Timer and Light. The oven also switches off automatically if no settings are selected within a certain period of time (approx. 30 minutes).</p> <p><i>S 1</i> The time of day display is turned on and is visible in the display.</p>
<i>P 2</i> Buzzer volume	<p><i>S 0</i> The buzzer is Off.</p> <p><i>S 1</i> to <i>S 21*</i> The buzzer is On. The volume can be changed. The corresponding buzzer will be heard when a status is selected.</p>
<i>P 3</i> Keypad tone	<p><i>S 0</i> The keypad tone is turned off.</p> <p><i>S 1*</i> The keypad tone is turned on.</p>
<i>P 4</i> Clock format	<p><i>24h</i> The time of day is shown in a 24-hour format.</p> <p><i>12h*</i> The time of day is shown in the 12-hour format. If you change the clock after 1 pm (13:00) from a 12-hour clock to a 24-hour clock, you will need to update the hours for the time of day accordingly.</p>

Clock / Timer

Setting	Status
P 5 Display brightness	5 1 to 5 7, 5 4* Different levels of brightness can be selected for the display. 5 1: Minimum brightness 5 7: Maximum brightness
P 6 Lighting	5 0* The oven interior lighting is on for 15 seconds and then turns off automatically. 5 1 The oven interior lighting is permanently turned on .
P 7 Temperature regulation	0 -3 to 3 The temperature can be modified so that it is slightly higher or lower than shown. The higher the level, the higher the cooking temperature.
P 8 Demo Mode	5 0* Select 5 0 and press OK for approx. 4 seconds. When - - - appears in the display the demo mode is deactivated . 5 1 Select 5 1 and press OK for approx. 4 seconds. When <i>DES_</i> appears in the display the demo mode is active . The oven can be operated, but the oven heating does not work. For personal use you do not need this setting.

* Factory default

System lock

The system lock  prevents the oven from being used unintentionally.

The system lock is set off by default. This can be changed by setting the status *S*:

- *S 0* = Off
- *S 1* = On



The status of the system lock can only be changed when the mode selector is in the Off position.

To activate the system lock

- Select OK.
- Move the symbol  with < or > until it appears under .



- Confirm with OK.

The currently set status *S 0* appears and the  symbol flashes under .



- Use < or > to set the status *S 1*.



- Confirm with OK.

The system lock is turned on.



When the appliance is turned on again, the  symbol will appear in the display to remind you that the system lock has been activated.

The system lock will remain activated even after a power failure.

Clock / Timer

Deactivating the system lock for a cooking process

- Select an operating mode.



The  and  symbols will appear along with the current time of day:





- Press and hold OK until  goes out.

The oven can now be used.

Deactivating the system lock

- Turn the mode selector to Off.
- Press and hold OK until  goes out.
- Select OK.
- Move the symbol  with < or > until it appears under .
- Confirm with OK.

The currently set status *S 1* appears and the  symbol flashes under .

- Use < or > to select the status *S 0*.
- Confirm with OK.

The system lock is Off.

The  symbol disappears.

Timer

The timer can be used to time any activity in the kitchen, e.g. boiling eggs.

The timer can also be used at the same time as a cooking program if a start and finish time have been set, e.g. a reminder to stir the dish or add seasoning.

A maximum time of 99 minutes and 55 seconds can be set for the timer.

Setting the timer

Example: Boiling eggs and setting the timer for 6 minutes and 20 seconds.

- Select Timer.

00:00 will appear in the display with ▲ flashing under △:



- Use < or > to set the timer as desired.



- Confirm with OK.

The timer settings are saved and will count down in seconds:



The △ symbol indicates that the timer has been set.

Clock / Timer

At the end of the timer

-  flashes,
- the time starts counting upwards,
- a signal will sound if turned on (see “Settings - P 2”).

- Select Timer.

The signal will turn off and the symbols in the display will go out.

Resetting the timer

- Select Timer.

The current timer appears.

- Change the time set with < or >.
- Confirm with OK.

The changed time is saved and will count down in seconds.

Canceling the timer

- Select Timer.
- Use < to reduce the timer to *00:00*.
- Confirm with OK.

The timer has been canceled.

Eating food which has been cooked correctly is important for good health.

Only bake cakes, pizza, french fries, etc. until they are golden brown. Do not overcook them.

Operating modes

Depending on how you would like the food prepared, you can use Conv Bake (Convection Bake) or Surround.

Bakeware

The bakeware used depends on the oven mode chosen and how the food is prepared.

- Conv Bake (Convection Bake):
Baking tray, Universal tray, any heat-resistant baking dishes
- Surround:
Dark metal, enamel or aluminum baking tins with a matte finish, as well as heat-resistant glass, ceramic and coated dishes can be used.
Avoid bright, shiny metal tins as they result in uneven or poor browning, and in some cases cakes might not cook properly.

- Always place baking pans on the wire rack.

Position rectangular pans with the longer side across the width of the rack. This will allow for optimum heat distribution and even baking results.

- When baking cakes with fruit toppings or deep cakes, place the pan in the universal tray to catch any spillages.

Parchment paper / Greasing the pan

All Miele accessories (baking tray, universal tray and round baking form) are treated with PerfectClean enamel.

Surfaces treated with PerfectClean enamel generally **do not need** to be greased or covered with parchment paper.

Parchment paper is only needed with:

- anything with a high salt content (e.g. pretzels, bread sticks), because sodium can damage the PerfectClean surface;
- meringues or dishes with a high egg-white content, because they are more likely to stick,
- frozen food cooked on the wire rack.

Bake

Temperature

As a general rule, select the lower temperature given in the chart.

Choosing a baking temperature higher than those recommended may reduce the cooking time, but will lead to uneven browning, and unsatisfactory cooking results.

Baking duration

Check if the food is cooked at the end of the shortest duration quoted. To check if a cake is ready insert a wooden skewer or toothpick into the center, it should come out clean.

Shelf levels

The shelf level that you place the food on for baking depends on the oven mode and the number of trays being used.

– Conv Bake (Convection Bake)

1 Tray: level 3

2 Trays: levels 1+3/2+4

3 Trays: levels 1+3+5

– Surround

1 Tray: Level 3

Bake moist cakes and muffins on a maximum of two levels at the same time.

Always follow USDA guidelines on food safety.

Operating modes

Depending on how you would like the food prepared, you can use Conv Bake (Convection Bake) or Surround.

Cookware

Any heat-resistant cookware can be used:

Roasting pans, heat-resistant glass/earthen/cast iron cookware, roasting bags, wire rack and the splash insert (if available) on top of the roasting pan.

We recommend roasting in a covered oven dish, this will ensure that enough stock will be prepared to make gravy. The oven will also stay cleaner than when roasting on the rack.

Temperature

As a general rule, select the lower temperature given in the chart. If higher temperatures are used, the meat will brown on the outside, but will not be properly cooked through.

When cooking with Conv Bake (Convection Bake), select a temperature 25°F (20°C) lower than when using Surround.

Select a temperature of approx. 25°F (10°C) lower than quoted in the roasting chart for meat weighing more than 6.5 lbs (3 kg). The roasting process will take longer, but the meat will cook evenly through and the skin or crackling will not be too thick.

When roasting on the rack, set a temperature approx. 10° lower than if using an oven dish.

Shelf levels

In most cases level 3 should be used. With large items, such as a turkey, use level 1 or 2.

Roast

Tips

- Browning: Browning only occurs towards the end of the roasting time. Remove the lid about halfway through the roasting time if a more intensive browning result is desired.
- Resting time: At the end of the program, take the roast out of the oven, cover with aluminum foil and let stand for about 10 minutes. This helps retain the juices when the meat is sliced.
- Roast Chicken: For a crisp skin, baste the poultry 10 minutes before the end of the cooking time with lightly salted water.

This cooking method is ideal for cooking beef, pork, veal or lamb when a tender result is desired.

First, using a cooktop sear the meat on all sides to seal in the juices.

Then place the meat in a preheated oven. It will be cooked at a low temperature for an extended time allowing the meat to become very tender.

The meat will rest and the juices start to circulate evenly throughout. This gives the meat a very tender and juicy result.

Tips

- Use fresh, lean meat that has been trimmed. Remove the bones before cooking.
- When searing, use a suitable cooking oil or fat that can withstand high temperatures (e.g. clarified butter, vegetable oil).
- Do not cover the meat during cooking.

Cooking will take approx. 2-4 hours, depending on the size and weight of the meat, as well as the desired degree of doneness and browning.

Operation

Use the universal tray with the grilling and roasting insert.

- Place the rack with the universal tray on shelf level 3.
- Select Surround and a temperature of 265°F (130°C).
- Preheat the oven along with the universal tray and wire rack for approx. 15 minutes.
- While the oven is preheating, sear the meat on all sides on the cooktop.

 Danger of burns!

When the oven is hot use pot holders to insert, remove or turn the food, or when adjusting the oven shelves, etc.

- Place the seared meat on the universal tray.
- Reduce the temperature to 210°F (100°C).
- Continue cooking until the end of the cooking time.

On ovens with a clock/timer, you can set the cooking process to finish automatically (see“Clock/Timer - Setting the cooking duration”).

Slow Roasting

After the cooking program

- Meat can be carved straight from the oven. It does not need to rest.
- The meat can be left in the oven after the program is complete. This will not affect results in any way.
- The meat is at an ideal temperature to eat straight away. Serve on pre-warmed plates with a hot sauce or gravy to keep warm.

Cooking time / Core temperatures

Always follow USDA guidelines on food safety.

Meat	Time [min]	Core Temp. [°F / °C] **
Fillet of beef	80–100	138 / 59
Roast beef		
- rare	50–70	118 / 48
- medium	100–130	135 / 57
- well done	160–190	156 / 69
Pork tenderloin	80–100	145 / 63
Smoked pork chop *	140–170	154 / 68
Veal fillet	80–100	140 / 60
Veal loin *	100–130	145 / 63
Saddle of lamb *	50–80	140 / 60

* boneless

** If desired, use a roast probe to monitor the core temperature.



Danger of burns!

Broil with the oven door closed. If you broil with the door open the hot air will escape from the oven before it has been cooled by the cooling fan.

The controls will get hot.

Oven modes

Broil

For broiling thin cuts of meat and browning.

The entire Browning / Broiling element will get hot and glow red.

Conv Broil (Convection Broil)

For broiling thicker items, e.g. roulades, poultry pieces.

The Browning / Broiling element and the fan turn on alternately.

Cooking accessories

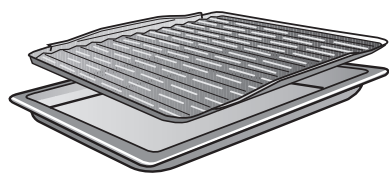

Use the universal tray with a grilling and roasting insert (if available) on top. The insert protects the oven from splatter and collects the juices underneath. The juices can then be used for gravy and sauces.

Temperature

As a general rule, select the lower temperature given in the chart. If higher temperatures are used, the meat will brown on the outside, but will not be properly cooked through.

Preheating

Always preheat the oven for about 5 minutes with the door closed before Broiling.

Shelf levels

Select the shelf level according to the thickness of the food.

- Thin cuts: Shelf level 4 or 5
- Thick cuts: Shelf level 2 or 3

Broiling duration

- Thinner cuts of meat/slices of fish require approx. 6–8 minutes per side. Thicker pieces require more time per side. It is best to broil food of a similar thickness at the same time so that the broiling time does not vary too much.
- Turn the food halfway through broiling.

Broil

Testing doneness

Always follow USDA guidelines for safe food temperatures.

Tip: If the surface of a thicker cut of meat is browned but the center is still raw, move the food to a lower level or reduce the temperature and continue cooking. This will stop the surface from becoming too dark.

Preparing food for broiling

Rinse the meat under cold water and pat dry. Do not season the meat with salt before broiling, this will draw out the juices.

Brush the meat with oil, if necessary. Do not use other types of fat as they can easily burn and cause smoke.

Clean fish as usual. To enhance the flavor, salt or lemon can be added.

Broil

- Place the grilling and roasting insert (if available) in the universal tray.
- Place the food on top.
- Select the Broil operating mode.
- Turn the temperature selector to Broil (.
- Preheat the Browning/Broiling element for approx. 5 minutes with the door closed.



Danger of burns!

When the oven is hot use pot holders to insert, remove or turn the food, or when adjusting the oven shelves, etc.

- Place the food on the appropriate shelf level (see the “Broiling chart”).
- Close the door.
- Turn the food halfway through cooking.

Use Conv Bake (Convection Bake) without setting the temperature to gently defrost food.

The fan will turn on and circulate air at room temperature around the oven cavity.

 Risk of salmonella poisoning!
Be sure to strictly observe proper hygiene rules when defrosting poultry.
Do not use the liquid from the defrosted poultry.

Tips

- Remove the packaging and place the frozen food on the universal tray or in a suitable bowl or dish.
- When defrosting poultry, place it on the wire oven rack and position the rack on the universal tray so that the poultry does not sit in the defrosting liquid.

Canning

Always follow the USDA canning guidelines.

Canning containers



Danger of injury!

Do not use the appliance to heat up or can food in sealed jars or containers. Pressure will build up inside them and they can explode causing damage to the appliance, as well as the risk of injury and scalding.

Only use jars designed for canning:

- Canning jars
- Jars with twist-off lids

Canning fruit and vegetables

The Conv Bake (Convection Bake) mode is recommended.

The instructions are for 6, 32 oz (1 liter) glass jars.

- Slide the universal tray onto shelf level 3. Place the jars on the tray.
- Select Conv Bake (Convection Bake) and a temperature of 300-340°F (150-170°C).
- Wait until bubbles rise evenly in the jars.

Then reduce the temperature to avoid a boil-over.

Fruit / Cucumbers

- As soon as bubbles begin to rise evenly in the jars, reduce the temperature to the lowest setting. Then, leave the jars in the warm oven for an additional 25-30 minutes.

Vegetables

- Reduce the temperature to 210°F (100°C) as soon as bubbles are visible in the jars.

	Canning time [min]
Asparagus	80-100
Carrots	50-70
Peas, Beans	80-100

- After the canning time has finished, reduce the temperature to the lowest setting and leave the jars in the oven for an additional 25-30 minutes.

After canning



Danger of burns!

Use pot holders when removing the jars from the oven.

- Take the jars out of the oven.
- Cover the jars with a towel and leave to set for approx. 24 hours.
- Make sure all jars are closed properly when storing them.

Dehydrate

Dehydrating is a traditional method of preserving fruit, certain vegetables and herbs.

It is important that fruit and vegetables are ripe and not bruised before they are dehydrated.

- Prepare the food for dehydrating.
 - Peel and core apples, and cut into slices 1/4" (.5 cm) thick.
 - Core plums if necessary.
 - Peel, core and cut pears into wedges.
 - Peel and slice bananas.
 - Clean mushrooms, then either halve or slice them.
 - Remove parsley and dill from the stem.
- Distribute the food evenly over the roasting pan.
- Select Conv Bake (Convection Bake) or Surround.
- Select a temperature of 175-210°F (80-100°C).
- Place the universal tray on shelf level 3.

When using Conv Bake (Convection Bake) you can dehydrate on levels 1+3 at the same time.

Food	Dehydrating time
Fruit	2–8 hours
Vegetables	3–8 hours
Herbs*	50–60 minutes

- * Use Surround when dehydrating herbs.
- Reduce the temperature if condensation begins to form in the oven.

 **Danger of burns!**
Use pot holders when removing the dehydrated food from the oven.

- Allow the fruit or vegetables to cool down after dehydrating.

Dried fruit must be completely dry, but also soft and elastic. Juice should not escape when cut.

- Store in sealed glass jars or tins.

Frozen food

Tips

Cakes, pizza, baguettes

- Bake on parchment paper placed on the wire oven rack.
Do not use the baking tray or the universal tray for frozen foods with a large surface area. The tray could become warped and difficult to remove from the oven when hot. Additional use will make the distortion worse.
- Use the lowest temperature recommended by the manufacturer.

French fries, croquettes and similar items

- These items can be cooked on the baking tray or universal tray.
Place baking parchment on the tray so that they cook gently.
- Use the lowest temperature recommended by the manufacturer.
- Turn several times during cooking.

Preparation

Eating food which has been cooked correctly is important for good health.

- Select the oven mode and temperatures recommended by the manufacturer.
- Preheat the oven.
- Place the food in the preheated oven on the recommended shelf level.
- Check the food at the end of the shortest time recommended on the packaging.



Danger of burns!

Make sure the heating elements are turned off and allowed to cool completely.



Danger of injury! The steam from a steam cleaner could reach electrical components and cause a short circuit.

Do not use a steam cleaner to clean this appliance.

All surfaces can discolor or be damaged if unsuitable cleaning agents are used. The front of the oven, in particular, will be damaged by oven cleaners and descalers.

All surfaces are susceptible to scratches. Scratches on glass surfaces could cause a breakage.

Remove any cleaning agent residues immediately.

Unsuitable cleaning agents

To avoid damaging surfaces when cleaning, do not use:

- Cleaners containing soda, ammonia, acids or chlorides
- Lime removers on the front of the ovens
- Abrasive cleaning agents, such as scouring powder, scouring cream, pumice stones
- Solvent-based cleaners
- Stainless steel cleaners
- Dishwasher cleaners
- Glass cleaners
- Ceramic cooktop cleaners
- Hard, abrasive sponges and brushes, such as pot scrubbers or used sponges that still contain traces of abrasive cleaner
- Eraser sponges
- Sharp metal scrapers
- Steel wool
- Spot cleaners
- Oven cleaners
- Stainless steel scouring pads

If stains and food residues are allowed to remain on surfaces for a longer period of time, it may no longer be possible to remove them. Continued use without cleaning will make the oven much harder to clean.

Remove any soiling immediately.

Cleaning and care

The accessories are not dishwasher-safe.

- Soiling caused by spilled fruit juices and cake mixtures is best removed while the oven is still warm. Use caution and make sure the oven is not too hot.
- To make cleaning easier, you can dismantle the oven door and remove the side runners.

Normal soiling

There is a seal around the oven interior which seals the inside of the door.

Take care not to rub, damage or move the gasket.



Do not clean the door gasket - the door gasket is essential for a good seal.

- Remove normal soiling immediately using a clean sponge with warm water and liquid dish soap applied with a clean, damp microfiber cloth.
- After cleaning, ensure that any detergent residue is removed with clean water. This is particularly important when cleaning surfaces treated with PerfectClean enamel as detergent residue can impair the non-stick properties.
- After cleaning, dry the surfaces with a soft cloth.

Stubborn soiling

Do not use a protective coating (i.e. tin foil) to line the oven and do not use commercial oven cleaner unless certified for use in a self-cleaning oven.

Remove coarse soiling from the oven and scrape any burnt-on residues off enameled surfaces with a glass scraper.

Use the Self Clean  program. See “Cleaning the oven interior with Self Clean ” for more information.

Spilled fruit and roasting juices may cause lasting discoloration or matte patches on enameled surfaces. This does not affect the functional characteristics of the finish. Do not attempt to remove these marks. Clean them following the instructions given here.

The cavity does not need to be treated with oven cleaner as it is equipped with a Self Clean  program.

- Baked on deposits can be removed with a glass scraper or with a non-abrasive steel wool pad, warm water and liquid dish soap.

- If necessary, the scouring pad on the back of a non-scratching washing-up sponge can be used to remove the soiling after the holding time.
- After cleaning, remove all oven cleaning agent residues thoroughly with clean water, and then dry the surfaces.

Cleaning and care

Self Cleaning the oven interior

Instead of cleaning the oven by hand you can use the Self Clean program .

During self cleaning the oven interior is heated up to over 750°F (400°C). Any residual soiling is broken down and reduced to ash by the high temperatures.

This oven has three levels for self cleaning, each with a different duration:

- Level 1 for light soiling,
- Level 2 for heavier soiling,
- Level 3 for very heavy soiling.

Once the Self Clean program has been started, the door will automatically locked. The door cannot be opened again until the program has ended.

If desired, the timer can be used to delay the start of the Self Clean program.

At the end of the program any residues, such as ash from the cleaning process, can be easily wiped away.

Preparing for the Self Clean program

Non-pyrolytic accessories will be damaged by Self Clean.

Remove all non-pyrolytic accessories from the oven before starting a Self Clean program. This also applies for optional accessories that are not suitable for the Self clean program.

The following accessories are suitable for cleaning with Self Clean and can remain in the oven during the program:

- Shelf runners
- Wire oven rack HBBR 30-2
- FlexiClips with wire rack HFCBBR 30-2
- Remove all accessories that are not suitable for the Self Clean program from the oven.
- Slide the wire oven rack into the top shelf level.

Heavy soiling in the oven can cause thick smoke to develop and can result in the Self Clean program being switched off.

Burnt-on residues can cause lasting discoloration or dull spots on enameled surfaces.

- Before starting the Self Clean program, remove coarse soiling from the oven and scrape any burnt-on residues off enameled surfaces with a glass scraper.

Starting the Self Clean program



Risk of burns!

When self cleaning the front of the oven becomes hotter than with normal oven use.

Prevent children from touching the oven during the Self Clean program.

- Select Clean (Self Clean).



PY 1 appears in the display. The number flashes.

Use < or > to select between *PY 1*, *PY 2* or *PY 3*.

- Select the Self Clean level desired.
- Confirm with OK.

The Self Clean program will now start.

 will appear in the display.





 will flash until the door is locked.

The oven heating and the cooling fan will then turn on automatically.

The oven light will not turn on during the Self Clean program.

To see how the Self Clean program is progressing, highlight  in the display.

- Select OK.
- If necessary, move the symbol  with < or > until it appears under .

The time remaining for the Self Clean program will appear in the display. The duration cannot be altered.

If you have set a timer you will hear a signal,  will flash and the time will count down. Once you press OK, the audible and visual signals will turn off. *PY* and the number of the Self Clean level chosen will reappear.

Cleaning and care

Delaying the start of the Self Clean program

Start the program as described and then set the desired finish time within the first five minutes of starting the program.

- Select OK.
 - Move the symbol ▲ with < or > until it appears under .
- :-: appears.

- Confirm with OK.

The display will then show the finish time calculated from the current time of day plus the duration of the selected Self Clean program.

- Set the desired finish time using < or >.
- Confirm with OK.

The finish time is now set and has been saved.

The oven heating will turn off.



The finish time can be changed at any time up until the start time for the program.

As soon as the start time is reached, the oven heating and the cooling fan will turn on. The duration will appear in the display.



At the end of the Self Clean program



0:00,  and  will appear in the display.

The door is locked as long as the  symbol is lit up. The  symbol will start flashing as soon as the door lock has been deactivated.

When the door lock has been deactivated:

-  goes out,
-  flashes,
- short signals will sound if the signal tone is activated (see “Settings – P 2”).

- Turn the mode selector to Off.

Acoustic and visual signals are turned off.

Danger of burns!

Danger of burns! Wait until the oven has cooled down before removing any residual soiling left in the oven compartment from the Self Clean program.

- Wipe any residues (e.g.ash) left behind after the Self Clean program out of the oven compartment and off of any accessories. The amount of ash will vary depending on how dirty the oven was.



Most soiling can be easily removed using a clean, soft sponge and a mild solution of warm water and liquid dish soap.

Depending on the degree of soiling before cleaning, there may be a visible layer of soiling across the inner glass pane on the door. This should be removed using the scouring side of a dish sponge or with a stainless steel spiral sponge and liquid dish soap.







Please note:

- There is a fiberglas seal around the oven interior which seals the inside of the door. Take care not to rub, damage or move the gasket. Do not clean the door gasket - the door gasket is essential for a good seal.
- Spilt fruit juices may cause lasting discoloration to enameled surfaces. This discoloration is permanent but will not affect the efficiency of the enamel. Do not attempt to remove these marks.

The Self Clean program is canceled

If the Self Clean program is cancelled, the oven door will remain locked until the temperature inside the oven drops to below 535°F (280°C). The  symbol will light up until the temperature has dropped below this level. The door can be opened as soon as the  symbol starts flashing.

The following will cause the Self Clean program to cancel:

- Turning the mode selector to Off.
Once the door has been unlocked,  will go out and the time of day will reappear in the display. If necessary, start the Self Clean program again.
- Turning the mode selector to a different function.
Py and  appear in the display. Once the door has been unlocked,  will go out and *Py* will flash.
- A power failure.
Py and  appear in the display. Once the door has been unlocked,  will go out and *Py* will flash.
When power is restored *Py* will light up until the temperature in the oven has dropped below 535°F (280°C).  will then appear in the display. The door lock releases and the time of day reappears.

Cleaning and care

Door removal

The door weighs approx. 18 kg).

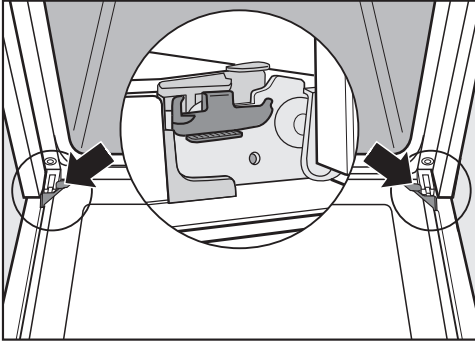

The oven door is connected to the hinges by retainers. Before removing the door from the retainers, the locking clamps on both hinges have to be released.

- Open the door fully.

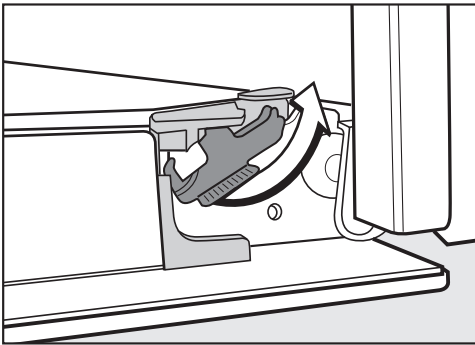

- Release the locking clamps by turning them as far as they will go.

Do not pull the door horizontally off its retainers, as they will spring back against the oven.

Do not pull the door off the retainers by the handle, as the handle could break off.

- Raise the door up till it rests partially open.



- Hold the door on either side and pull it diagonally upwards from the hinge guides. Make sure that you lift the door off straight.

Reinstalling the door

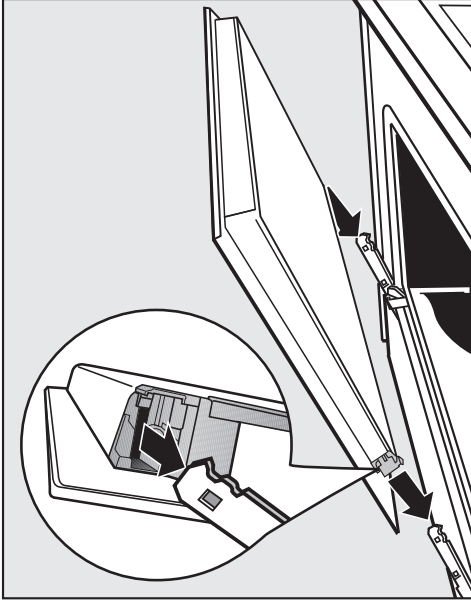

- Hold both sides of the door securely and carefully fit it onto the brackets of the hinges. Make sure that the door goes on straight.

- Open the door fully.

If the locking clamps are not locked, the door can easily become detached from the brackets and be damaged.

You must make sure that the locking clamps are locked again.

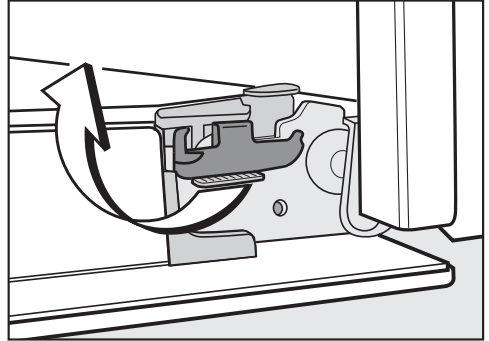

- To relock the locking clamps, turn them back up to the horizontal position as far as they will go.

Cleaning and care

Removing the shelf runners

 **Danger of injury!**
Do not use the oven without the shelf runners correctly inserted.

 **Danger of burns!** Make sure the heating elements are turned off and that the oven cavity is cool.

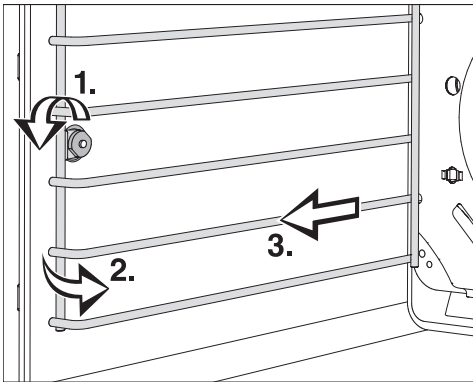

- Loosen the screw (1.).
- Pull the runners out of the holder (2.) at the front of the oven, and then pull them out of the oven (3.).



The runners can be **reinstalled** in the reverse order.

- Be sure that all parts are installed correctly.

Frequently Asked Questions

With the help of the following guide minor faults in the performance of the machine, some of which may result from incorrect operation, can be remedied without contacting the Service Department.

This guide may help you to find the reason for the fault, and how to correct it.

Problem	Possible cause and solution
This display is dark.	<p>There is no power to the appliance.</p> <ul style="list-style-type: none"> ■ Check if the circuit breaker has tripped.
The oven does not heat up.	<p>Only an oven mode or a temperature has been selected.</p> <ul style="list-style-type: none"> ■ Select a mode and a temperature. <p>The system lock  is On.</p> <ul style="list-style-type: none"> ■ Turn off the system lock (see “System lock ”). <p>There is no power to the appliance.</p> <ul style="list-style-type: none"> ■ Check if the circuit breaker has tripped. If it has, contact a qualified electrician or Miele. <p>Demo mode has been activated. <i>nES_</i> appears in the display.</p> <p>The oven can be operated but does not heat up.</p> <ul style="list-style-type: none"> ■ Deactivate Demo mode (see “Settings – P 8”).
12:00 flashes in the display.	<p>There has been a power failure.</p> <ul style="list-style-type: none"> ■ Reset the time of day (see “Using for the first time”). <p>Cooking times will also need to be reset.</p>
0:00 appears unexpectedly in this display and the  symbol flashes at the same time. The signal may also be sounding.	<p>The oven has been operating for an unusually long period of time, this has activated the “Safety switch-off feature”.</p> <ul style="list-style-type: none"> ■ Turn the mode selector to OFF. The oven is now ready to use.

Frequently Asked Questions

Problem	Possible cause and solution
F 32 appears in the display.	<p>The Self Clean program door lock is not locking.</p> <ul style="list-style-type: none"> ■ Turn the mode selector to the Self Clean program again. <p>If the problem persists, contact Miele Technical Service.</p>
F 33 appears in the display.	<p>The door lock for the Self Clean program will not deactivate.</p> <ul style="list-style-type: none"> ■ Turn the mode selector to the Off position and turn the oven off. <p>If the problem persists, contact Miele Technical Service.</p>
F XX appears in the display.	<p>A fault has occurred that you cannot resolve.</p> <ul style="list-style-type: none"> ■ Contact Miele Technical Service.
A noise is heard after the cooking process is complete.	<p>After the cooking process the cooling fan will continue to run for a while after a program is complete to prevent moisture from building up in the oven, on the control panel or surrounding cabinetry. The cooling fan will turn off automatically.</p>
The oven has turned itself off.	<p>The oven turns off automatically if a button is not pressed after a certain amount of time or after a cooking program has ended to save power.</p> <ul style="list-style-type: none"> ■ Turn the oven back on.
The oven lighting turns off after a short time.	<p>The oven is factory set to turn off automatically after 15 seconds. This setting can be changed (see “Settings overview – P 6”).</p>
Baked goods are not cooked properly after following the times given in the chart.	<p>A different temperature than that given in the recipe was used.</p> <ul style="list-style-type: none"> ■ Select the temperature required for the recipe.
	<p>The ingredient quantities are different from those given in the recipe.</p> <ul style="list-style-type: none"> ■ Double check the recipe. The addition of more liquid or more eggs will make a wetter mixture which will take longer to cook.

Frequently Asked Questions

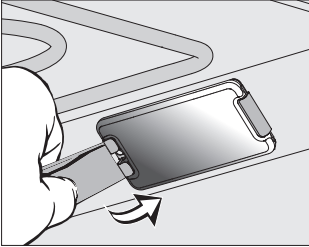
Problem	Possible cause and solution
<p>The browning is uneven.</p>	<p>The wrong temperature or shelf level was selected.</p> <ul style="list-style-type: none"> ■ There will always be a slight unevenness. If the unevenness is great, check whether the correct temperature and shelf level were selected. <p>That material or color of the bakeware is not suitable for the oven mode selected.</p> <ul style="list-style-type: none"> ■ When using Surround, use matte, dark colored pans. Light colored, shiny pans will not produce as desirable results.
<p>The oven lighting does not turn on.</p> 	<p>The halogen bulb needs to be replaced.</p> <div style="border: 1px solid gray; padding: 5px; margin: 5px 0;"> <p>⚠ Danger of burns! Make sure the heating elements are turned off and allowed to cool completely.</p> </div> <div style="border: 1px solid gray; padding: 5px; margin: 5px 0;"> <p>The lamp cover may be damaged if it falls. When removing the cover hold it firmly so that it does not fall. Place a towel on the oven floor and open door to avoid damage.</p> </div> <ul style="list-style-type: none"> ■ Disconnect the appliance from the power supply. ■ Loosen the bulb cover with the tool supplied at the back of the frame. ■ Do not touch the halogen bulb with bare fingers. Observe the manufacturer's instructions. Remove the halogen bulb. ■ Replace it with a new halogen bulb (Sylvania 66740, 120 V, 40 W, G9, FS1). ■ Press the bulb cover back into place. ■ Reconnect the oven to the electrical supply.
<p>There is soiling in the over after the Self Clean program.</p>	<p>The Self Clean program burns off soiling in the oven and leaves it as ash.</p> <ul style="list-style-type: none"> ■ Using a soft sponge, warm water and liquid dish soap remove the ashes. If coarse soiling remains, start the Self Clean program again with a longer duration.

Frequently Asked Questions

Problem	Possible cause and solution
The rack and other accessories make a noise when being pushed into or pulled out of the oven.	<p>The heat resistant surface of the shelf runners creates friction when accessories are taken in and out of the oven.</p> <ul style="list-style-type: none">■ To reduce the friction, lubricate the runners with a few drops of cooking oil applied with a paper towel. Repeat this process after each Self Clean program.

Contact in case of fault

In the event of a fault which you cannot remedy yourself, please contact your Miele dealer or Miele Technical Service.

Contact information for Miele Technical Service can be found at the end of this document.

Please quote the model and serial number of your appliance when contacting Miele. Both pieces of information can be found on the data plate.

You will find this information on the data plate, which is behind the toe-kick cover.

Warranty

For further information, please refer to your warranty booklet.

Please have the model and serial number
of your appliance available when
contacting Technical Service.

The Miele logo consists of the word "Miele" in a bold, white, serif font, set against a solid black rectangular background.

U.S.A.

Miele, Inc.

National Headquarters

9 Independence Way
Princeton, NJ 08540
Phone: 800-843-7231
Fax: 609-419-4298
www.mieleusa.com

Technical Service & Support

Phone: 800-999-1360
Fax: 888-586-8056
TechnicalService@mieleusa.com

International Headquarters

Miele & Cie. KG
Carl-Miele-Straße 29
33332 Gütersloh
Germany

Canada

Importer
Miele Limited

Headquarters and Miele Centre

161 Four Valley Drive
Vaughan, ON L4K 4V8
www.miele.ca

Customer Care Centre

Phone: 800-565-6435
905-532-2272
customercare@miele.ca

HR1724

en-US, CA

M.-Nr. 10 819 160 / 023