

Miele



Fully Integrated 36" MasterCool

All Refrigerator:

K 2902 Vi / K 2912 Vi

All Freezer:

F 2902 Vi / F 2912 Vi

Bottom Mount:

KF 2902 Vi / KF 2912 Vi

French Door:

KF 2982 Vi

Shown: KF 2982 Vi

Info subject to change

mieleusa.com

Miele Help Desk (P): (800) 999-1360

Fully Integrated 36" MasterCool

SPECIFICATIONS			
Overall Unit Dimensions	35 ³ / ₄ " (908 mm) W x 83 ³ / ₄ " - 85 ³ / ₁₆ " (2127 - 2164 mm) H x 24" (610 mm) D [Depth does not include door panel]		
Niche			
Minimum Cabinet Niche Opening	36" (915 mm) W* x 84" - 85 ³ / ₁₆ " (2134 - 2164 mm) H x 24 ³ / ₄ " (629 mm) D		
Electrical	K 29x2 Vi	F 29x2 Vi	KF 29x2 Vi
Electrical Requirements	110V / 120V, 60Hz, 15 Amps In the case of side-by-side installations, a separate outlet must be used for each appliance.		
Power Cord	NEMA 5-15 plug, 5 ft (1.52 m)		
Plumbing	K 29x2 Vi	F 29x2 Vi	KF 29x2 Vi
Water Supply Requirements	-	Connect to a cold water supply only. Do not connect to a low-mineral or a reverse osmosis system. Must be connected to a shut-off valve. The water shut-off valve must be accessible after installation. The water pressure must be between 29 psi (2 bar) and 116 psi (8 bar). If the pressure is higher than 120 psi (8.3 bar), a pressure reducing valve must be installed.	
Water Connection Line	-	Standard 1/4" O.D flexible water line. Water line is not included.	
Shipping	K 29x2 Vi	F 29x2 Vi	KF 29x2 Vi
Shipping Weight	435 lbs (197 kg)	462 lbs (210 kg)	507 lbs (230 kg)
Shipping Dimensions	40" (1016 mm) W x 89 ¹³ / ₁₆ " (1,294 mm) H x 29 ¹ / ₄ " (800 mm) D		

Please note the following:

- This specification sheet is for a single built-in unit.
- When combining multiple MasterCool units side-by-side, please refer to the Merging Kit specification sheet.

*If design calls for a partition less than 6 ⁵/₁₆" (160 mm) the left unit's cutout will require an additional ¹/₈" (3 mm) to the width to allow installation of the Heating Mat/Merge Kit.



K 2902 Vi (Right Hinged)
Material# 11502710

K 2912 Vi (Left Hinged)
Material# 11502720



F 2902 Vi (Right Hinged)
Material# 11503360

F 2912 Vi (Left Hinged)
Material# 11503390



KF 2902 Vi (Right Hinged)
Material# 11502930

KF 2912 Vi (Left Hinged)
Material# 11502940



KF 2982 Vi (French Door)
Material# 11503020

Fully Integrated 36" MasterCool

CUTOUT DIMENSIONS

- Niche depth assumes a 3/4" (19 mm) panel, please adjust according to custom panel thickness

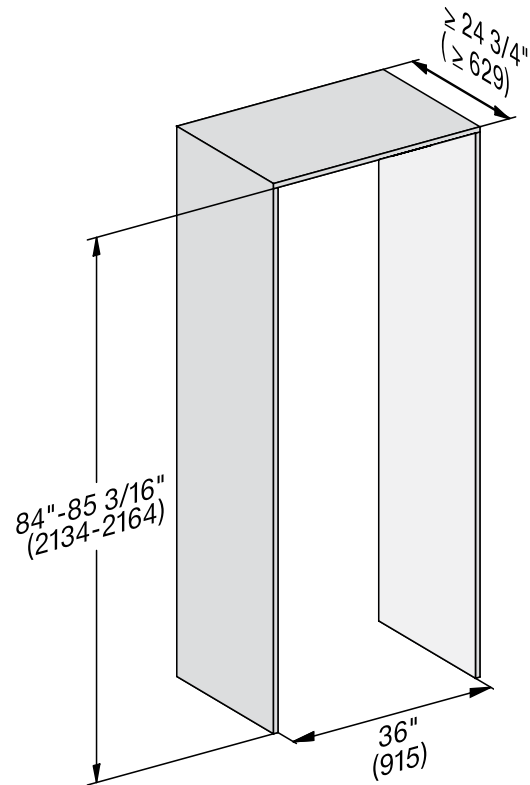

CUTOUT DETAILS

- The electrical connection must not be positioned higher than 9" (228.6 mm) above the floor.

For All Freezers and Bottom Mount units only:

- The 1/4" (6.4 mm) plumbed water connection should not be positioned higher than 2" (50.8 mm) above the floor.

Notes:

In case of an emergency the electrical outlet and water shutoff must be easily accessible and must not be concealed behind the appliance.

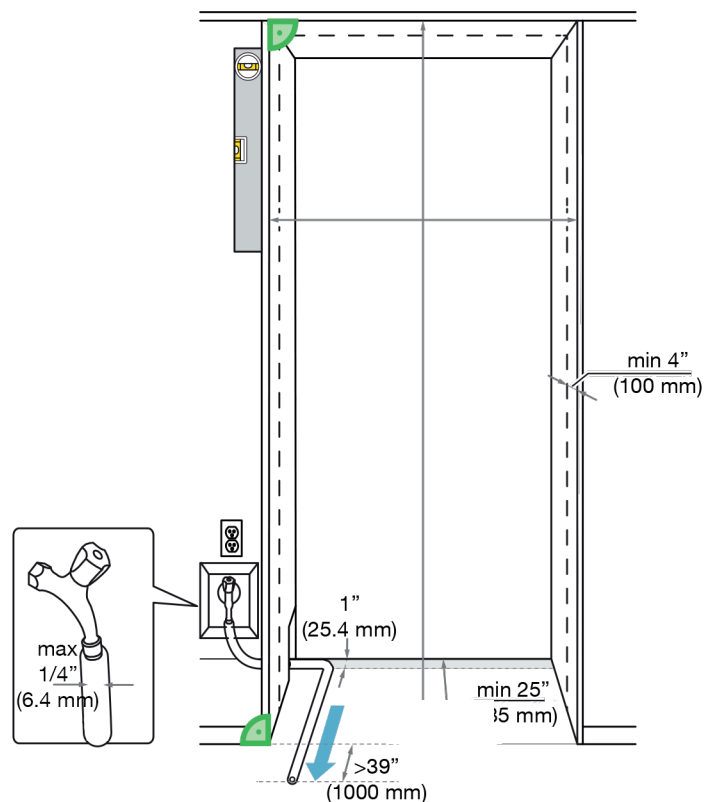

Fully Integrated 36" MasterCool

ELECTRICAL AND WATER CONNECTION

(Water Connection For F 29x2 Vi & KF 29x2 Vi Only)

Rear View

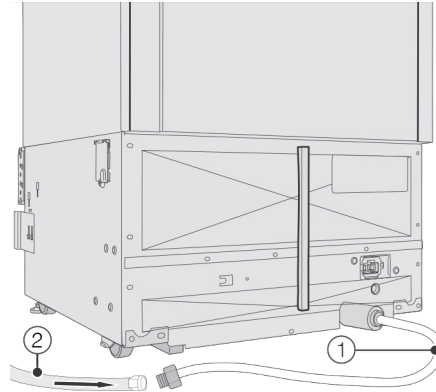

Water Connection:

- 1/4" water line is required
- Located at the rear of the appliance on a 4' 11" line.
- 1/4" compression fitting, ready to accept 1/4" line.

Side View

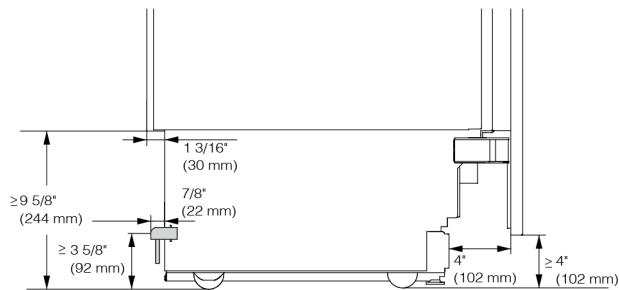

Notes:

- In case of an emergency the electrical outlet and water shutoff must be easily accessible and must not be concealed behind the appliance.
- In the event that connection points are located behind the unit the electrical outlet and water connection should be located no higher than $9 \frac{5}{8}$ " from the floor.

Fully Integrated 36" MasterCool

CUSTOM PANEL DETAILS

For Models:

- F 2902 Vi • F 2912 Vi
- K 2902 Vi • K 2912 Vi

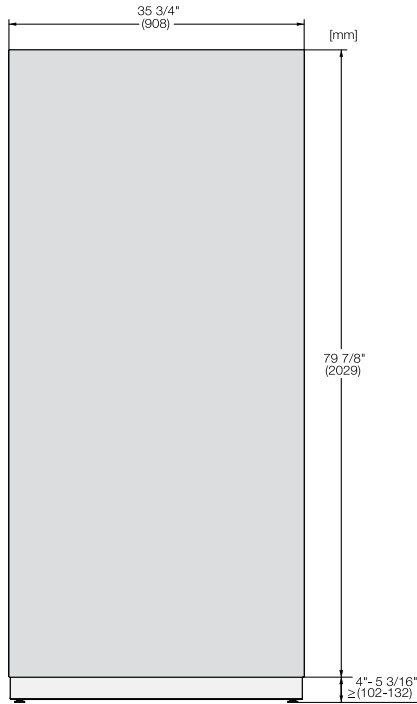

Max. Panel Weight:
F 29x2 Vi - 68;bs
K 29x2 Vi - 106 lbs

Optional Accessory:
Clean Touch Steel Panel:
• KFP 3605
Material# 11499100

For Models:

- KF 2902 Vi • KF 2912 Vi

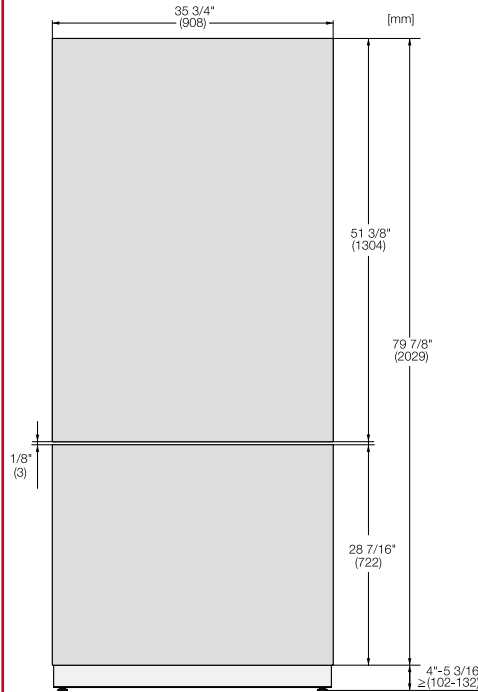

Max. Top Panel Weight: 86 lbs
Max. Bottom Panel Weight: 19 lbs

Optional Accessory:
Clean Touch Steel Panel:
• KFP 3615 - Top Panel
Material# 11499140
• KFP 3625 - Bottom Panel
Material# 11499150

For Models:

- KF 2982 Vi

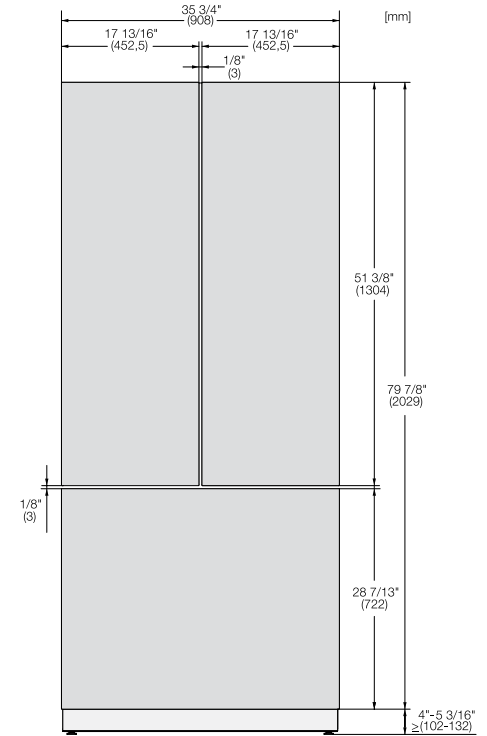

Max. Top Panel Weight (x2): 150 lbs
Max. Bottom Panel Weight: 19 lbs

Optional Accessory:
Clean Touch Steel Panel:
• KFP 3635 - Top Panel
Material# 11499420
• KFP 3625 - Bottom Panel
Material# 11499150

Panel Notes

If the adjoining cabinets are taller than the height of machine (HOM) - the front panel may be extended accordingly. Simply maintain the toe kick height and extend the panel the needed distance.

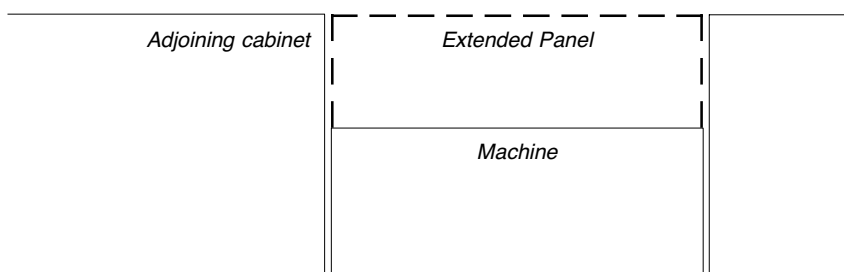

Fully Integrated 36" MasterCool

HINGING DETAILS 115° OPENING

Available for the following models:

- K 29x2 Vi
- F 29x2 Vi
- KF 29x2 Vi

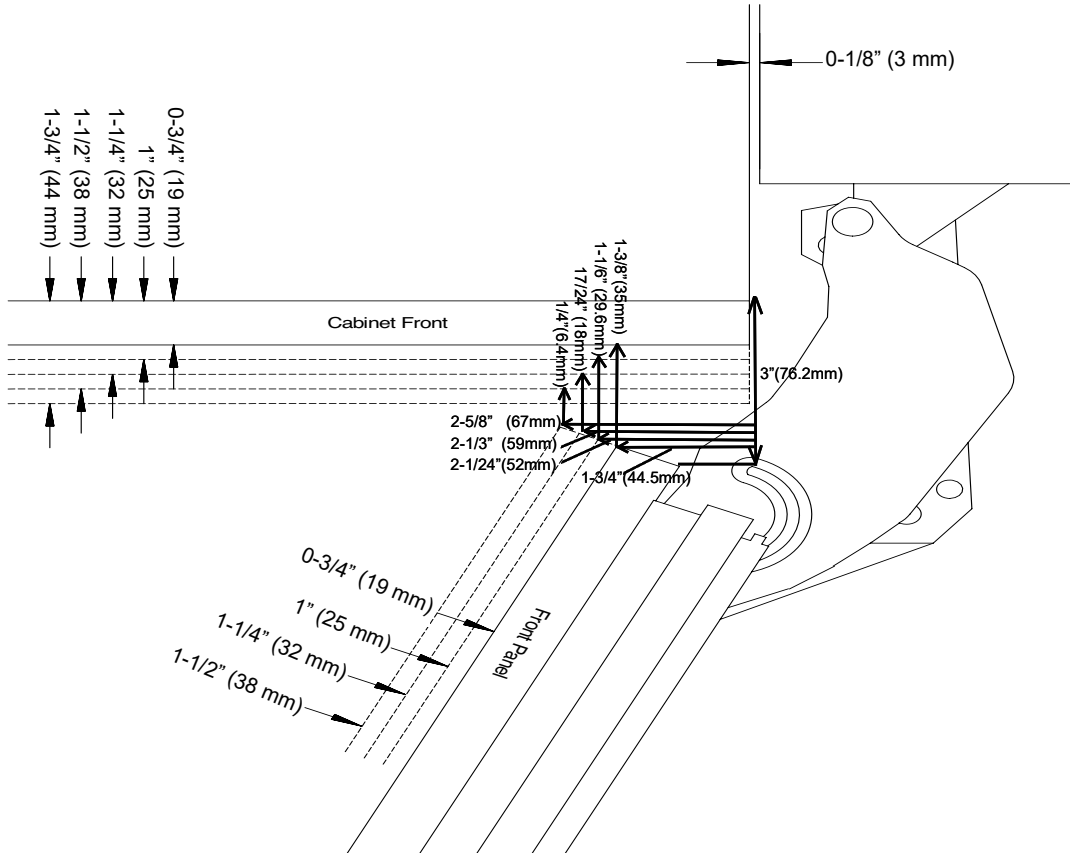

Top View
(K 29x2 Vi, F 29x2 Vi, KF 29x2 Vi)

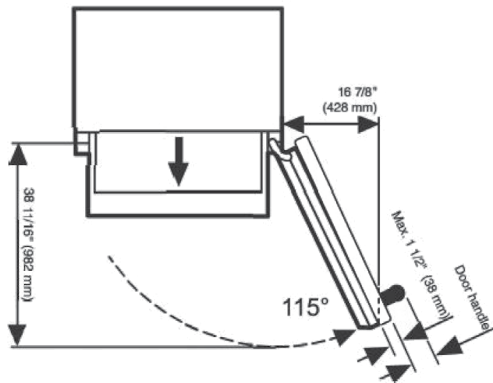

Top View
(KF 2982 Vi)

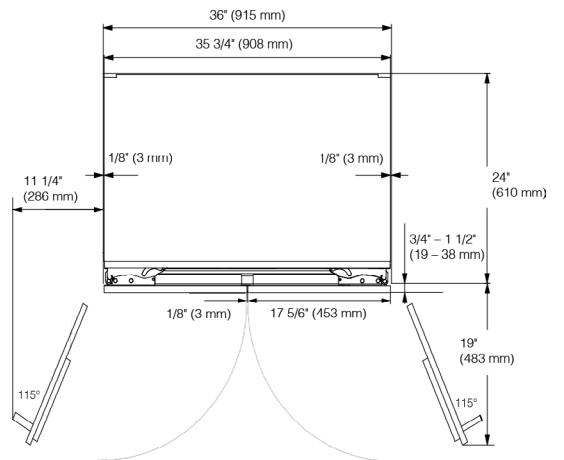

Fully Integrated 36" MasterCool

HINGING DETAILS 90° OPENING

Available for the following models:

- K 29x2 Vi
- KF 29x2 Vi

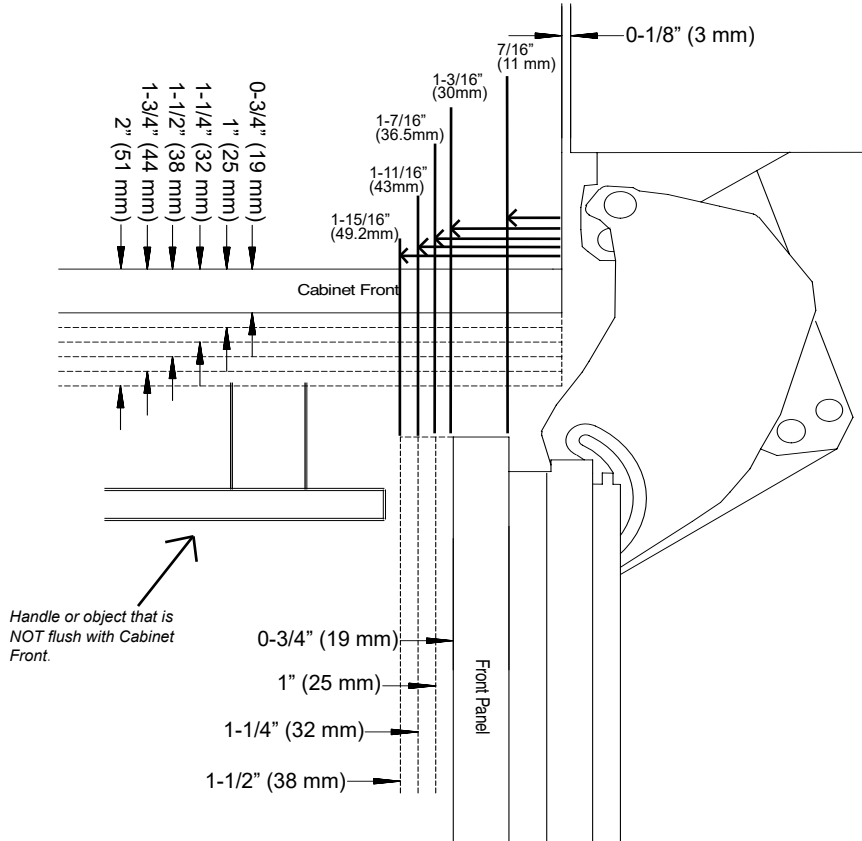
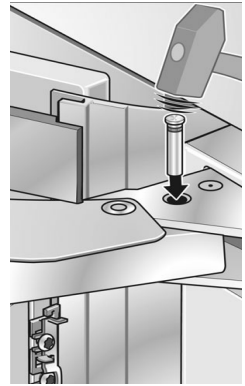

Top View
(K 29x2 Vi, KF 29x2 Vi)

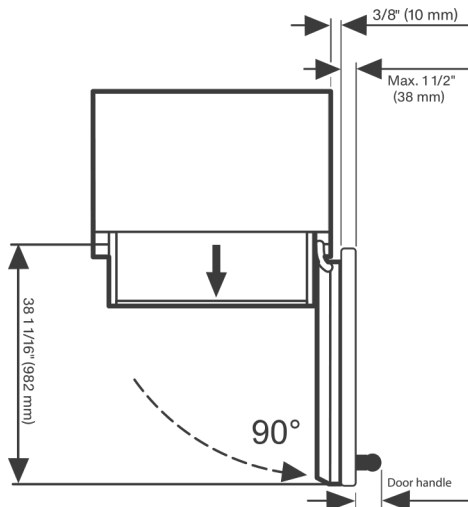

Top View
(KF 2982 Vi)

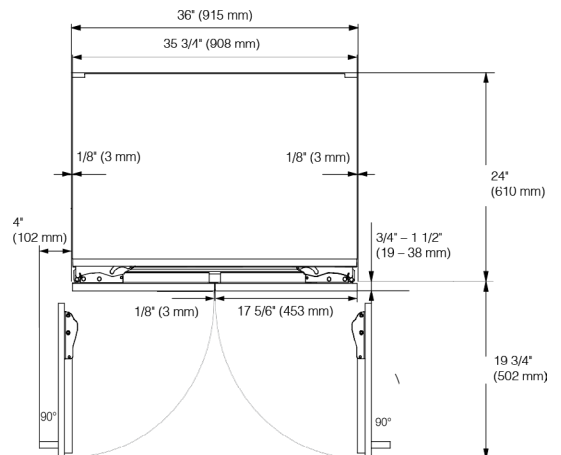

Freezer units cannot be stop pinned at 90°