

Product and Cut-out Dimensions

Micro Housing

MLT4601

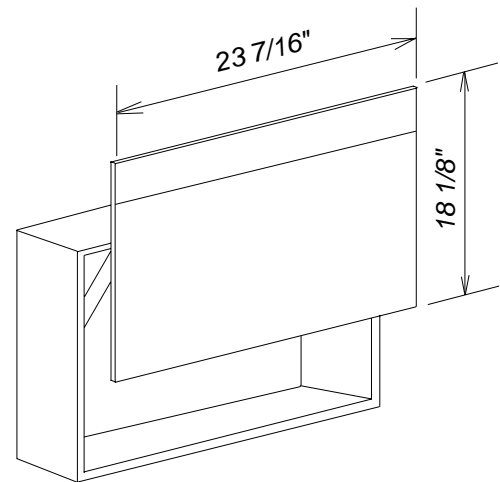
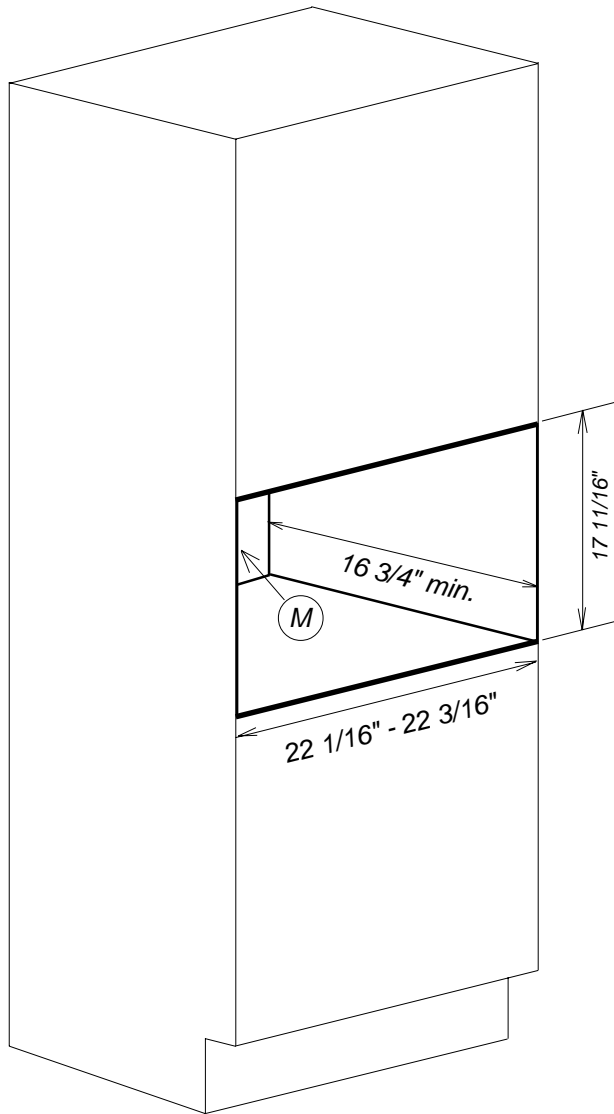

Location Codes
M - 110 Volt - 15 Amp - 3-wire device. (1 live / neutral / ground).
Notes
• All installations must be done in accordance with local codes.

NOTE: Drawing is not to scale.
SPECIFICATION SHEETS 240609